

VersaView 5000 ThinManager Thin Clients and Industrial Computers

Catalog Numbers 6200P, 6200T, 6200V



Important User Information

Read this document and the documents listed in the additional resources section about installation, configuration, and operation of this equipment before you install, configure, operate, or maintain this product. Users are required to familiarize themselves with installation and wiring instructions in addition to requirements of all applicable codes, laws, and standards.

Activities including installation, adjustments, putting into service, use, assembly, disassembly, and maintenance are required to be carried out by suitably trained personnel in accordance with applicable code of practice.

If this equipment is used in a manner not specified by the manufacturer, the protection provided by the equipment may be impaired.

In no event will Rockwell Automation, Inc. be responsible or liable for indirect or consequential damages resulting from the use or application of this equipment.

The examples and diagrams in this manual are included solely for illustrative purposes. Because of the many variables and requirements associated with any particular installation, Rockwell Automation, Inc. cannot assume responsibility or liability for actual use based on the examples and diagrams.

No patent liability is assumed by Rockwell Automation, Inc. with respect to use of information, circuits, equipment, or software described in this manual.

Reproduction of the contents of this manual, in whole or in part, without written permission of Rockwell Automation, Inc., is prohibited.

Throughout this manual, when necessary, we use notes to make you aware of safety considerations.



WARNING: Identifies information about practices or circumstances that can cause an explosion in a hazardous environment, which may lead to personal injury or death, property damage, or economic loss.



ATTENTION: Identifies information about practices or circumstances that can lead to personal injury or death, property damage, or economic loss. Attentions help you identify a hazard, avoid a hazard, and recognize the consequence.

IMPORTANT

Identifies information that is critical for successful application and understanding of the product.

Labels may also be on or inside the equipment to provide specific precautions.



SHOCK HAZARD: Labels may be on or inside the equipment, for example, a drive or motor, to alert people that dangerous voltage may be present.



BURN HAZARD: Labels may be on or inside the equipment, for example, a drive or motor, to alert people that surfaces may reach dangerous temperatures.



ARC FLASH HAZARD: Labels may be on or inside the equipment, for example, a motor control center, to alert people to potential Arc Flash. Arc Flash will cause severe injury or death. Wear proper Personal Protective Equipment (PPE). Follow ALL Regulatory requirements for safe work practices and for Personal Protective Equipment (PPE).

	Preface	
	Summary of Changes	7
	Abbreviations	8
	Additional Resources	8
	Chapter 1	
VersaView 5400 Industrial Computer Features	Operating Systems	9
	Computer Options	10
	Hardware Features	11
	Chapter 2	
VersaView 5200 ThinManager Thin Client Features	Thin Client Options	13
	Hardware Features	14
	Chapter 3	
Install the Thin Client or Computer	Before You Begin	17
	Parts List	17
	Installation Precautions	18
	Environment and Enclosure Information	18
	European Union Directive	18
	Installation Precautions for VersaView Devices for Hazardous Locations	19
	Installation Guidelines	21
	Enclosure Guidelines	22
	Mounting Clearance Requirements	22
	Dimensions	23
	Required Tools	25
	Install the Thin Client or Computer	25
	Panel Mounting Guidelines	25
	Panel Cutout Dimensions	26
	Mount an Integrated Display Model in a Panel	26
	VESA Mounting	28
	Mount a Non-display Model	28
	Connect Peripherals	29
	Connect Power	31
	Connect DC Power	31
	AC Power Options	33

Operate the Thin Client or Computer	<p>Chapter 4</p> <p>Operating Guidelines..... 35</p> <p>Touch Screen Precautions..... 36</p> <p> Touch Screen Driver Software..... 36</p> <p>Start the Thin Client or Computer..... 37</p> <p>Restart the Thin Client or Computer..... 38</p> <p>Shut Down the Thin Client or Computer..... 38</p>
Configure the UEFI (BIOS) Settings	<p>Chapter 5</p> <p>Set-up Utility Overview..... 39</p> <p>Access the Set-up Utility..... 40</p> <p>UEFI Overview..... 40</p> <p> Help Window..... 40</p> <p>H/W Monitor..... 40</p> <p>Security..... 40</p> <p>Restore the OS Image..... 41</p> <p>Upgrade to a New UEFI..... 42</p> <p> For All VersaView 5000 ThinManager® Thin Client and Industrial Computers Except Cat. No. 6200T-BA..... 42</p> <p> For VersaView 5200 ThinManager Thin Client Cat. No. 6200T-BA..... 44</p>
Troubleshoot the System	<p>Chapter 6</p> <p>Hardware (H/W) Monitoring..... 47</p> <p>Troubleshooting..... 48</p> <p>Load the System Defaults..... 48</p> <p>Ship or Transport the Computer..... 49</p> <p>Dispose of the Computer..... 49</p>
Clean the Thin Client or Computer	<p>Chapter 7</p> <p>Clean the Thin Client or Computer..... 51</p> <p> Clean the Integrated Display..... 52</p> <p> Clean the Air Openings and Cooling Fins..... 52</p> <p> Remove Paint and Grease from Bezel..... 52</p>
Install Accessories	<p>Appendix A</p> <p>Available Accessories..... 53</p> <p>Disconnect Power..... 53</p> <p>Electrostatic Discharge Precautions..... 54</p> <p>Pre-configuration..... 54</p> <p>Post-configuration..... 55</p> <p>Required Tools..... 55</p>

Replace a Factory-installed Bookshelf Mounting Plate
 (Cat. No. 6200V-BXWALL) 55
 Bookshelf Mounting Plate (Cat. No. 6200V-BXWALL2)
 For VersaView 5200 ThinManager Thin Client Non-display
 Computer (Cat. No. 6200T-BA) 56
 Install the VESA Mounting Plate (Cat. No. 6200V-BXVESA) 56
 VESA Mounting Plate (Cat. No. 6200V-BXVESA2)
 For VersaView 5200 ThinManager Thin Client Single
 Display Model (Cat. No. 6200T-BA) 58
 Install the DIN Rail Mounting Kit (Cat. No. 6200V-BXDIN) 59
 DIN Rail Mounting Kit (Cat. No. 6200V-BXDIN2) For
 VersaView 5200 ThinManager Thin Client Single Display
 Model (Cat. No. 6200T-BA) 61
 Install the Machine Mounting Bracket Kit
 (Cat. No. 6200V-BXMACH) 62
 Machine Mounting Bracket Kit (Cat. No. 6200V-BXMACH2)
 For Non-display VersaView 5200 ThinManager Thin Client
 Multi-4K Display Models (Cat. Nos. 6200T-RC and
 6200T-RE) 65
 Install the Legacy Mounting Plate (Cat. No. 6200V-BXLGCY) ... 66

Index
 69

Notes:

This manual is a user guide for VersaView® 5000 ThinManager® thin client and industrial computers. It provides procedures to the following:

- Install the thin client or industrial computer.
- Make thin client or industrial computer connections.
- Operate the thin client or industrial computer.
- Troubleshoot the thin client or industrial computer.

Summary of Changes

This manual contains new and updated information as indicated in this table.

Topic	Page
Added publication 6200-IN001 to the Additional Resources table.	8
Revised Product Certifications URL in the Additional Resources table.	8
Added Cat. Nos. 6200P-NS3A1K, 6200P-NS3B1K, 6200P-NS3C1K, and 6200P-NS3C6 to Table 1.	10
Added both footnotes to Table 1.	10
Added Cat. Nos. 6200P-NS3x1K and 6200P-NS3C6 to Figure 1 title.	11
Added Cat. No. 6200T-NAK to Table 2.	13
Added footnote 1 to Table 2.	13
Added Cat. No. 6200T-NAK to Figure 4 title.	14
Added footnote 5 to the table in the Parts List section.	17
Added paragraph that applies only to VersaView devices for hazardous locations in Environment and Enclosure Information subsection.	18
Updated Product Certification website URL in European Union Directive subsection.	18
Added Installation Precautions subsection for VersaView devices for hazardous locations.	19
Added that an AC power supply cannot be used in hazardous locations in the Important table.	21
Added Cat. Nos. 6200P-NS3x1K, 6200P-NS3C6, and 6200T-NAK to Table 3.	21
Added Cat. Nos. 6200P-NS3x1K, 6200P-NS3C6, and 6200T-NAK to the maximum humidity table.	22
Added Cat. Nos. 6200P-NS3x1K, 6200P-NS3C6, 6200T-NAK, and the Important table to Figure 8.	23
Revised Figure 11 to show only one model for illustrative purposes.	28
Added a table title to what is now Table 4.	29
Added the non-hazardous only, and non-hazardous and hazardous location type columns in Table 4.	29
Replaced Cat. No. 6200V-MDPDP with Cat. No. 6200V-MDP2HDMI4K in Table 4.	29
Replaced Cat. No. 6200V-MDPHDMI4K30 with Cat. No. 6200V-MDP2DP in Table 4.	29
Added the following Cat. Nos. as available accessories in Table 4: 6200V-BXDIN, 6200V-BXDIN2, 6200V-BXLGCY, 6200V-BXVESA, 6200V-BXVESAS2, 6200V-BXWALL, 6200V-BXWALL2, and 6200V-PLUGS	29
Added Arc Hazard table for accessories that can be used in hazardous locations.	30
Added Protective I/O Port Dust Caps, Cat. No. 6200V-PLUGS subsection.	30
Revised first sentence in Tip table about supplied DC terminal blocks.	32
Revised the second Attention table in the Connect Power section to apply to computers with a Windows OS.	31
Added the cross-reference to step 2 in the Connect DC Power subsection.	32
Added Cat. Nos. 6200P-NS3x1K, 6200P-NS3C6, and 6200T-NAK as applicable models for photo 1.	32
Added step 4 to the Connect DC Power subsection.	32
Added the cross-reference to step 6 in the Connect DC Power subsection.	32
Added step 4 to the removal instructions.	55, 57, 60, 62, 67
Added cross-references to Table 4 for what accessories work with what VersaView device Cat. Nos.	55, 56, 59, 62, 66

Abbreviations

This publication can use the following abbreviations.

Abbr	Meaning	Abbr	Meaning
BIOS	Basic input/output system	PCB	Printed circuit board
CF	CompactFlash	PCDC	Product Compatibility and Download Center
CMOS	Complementary metal oxide semiconductor	PCI	Peripheral component interconnect
COM	Communication (serial port interface)	PCIe	Peripheral component interconnect express
DDR	Double data rate (RAM)	PELV	Protective extra-low voltage
DIMM	Dual in-line memory module	POST	Power on self-test
DP	DisplayPort (digital display interface)	RAM	Random access memory
DVI	Digital video interface	RTC	Real-time clock
EEA	European Environment Agency	SELV	Safety extra low voltage
EMC	Electromagnetic compatibility	SSD	Solid-state drive
ESD	Electrostatic discharge	TFT	Thin film transistor
IEC	International Engineering Consortium	UEFI	Universal extensible firmware interface
LAN	Local area network	USB	Universal serial bus
NDM	Non-display model	UPS	Uninterruptible power source
NEMA	National Electrical Manufacturers Association	VGA	Video graphics array
PCAP	Protective capacitive (touch screen)		

Additional Resources

These documents contain additional information about related products from Rockwell Automation.

Resource	Description
Industrial Computer and Monitor Specifications Technical Data, publication IC-TD001	Provides technical specifications for Rockwell Automation industrial computers and monitors, which includes VersaView computers.
VersaView 5000 Thin Clients, Industrial Computers, and Accessories for Hazardous Locations Installation Instructions, publication 6200-IN001	Provides installation precautions, guidelines, and instructions for VersaView 5000 devices and accessories for hazardous locations.
Industrial Automation Wiring and Grounding Guidelines, publication 1770-4.1	Provides general guidelines to install a Rockwell Automation industrial system.
Product Certifications website, rok.auto/certifications	Provides declarations of conformity, certificates, and other certification details.

You can view or download publications at <http://www.rockwellautomation.com/global/literature-library/overview.page>. To order paper copies of technical documentation, contact your local Allen-Bradley distributor or Rockwell Automation sales representative.

VersaView 5400 Industrial Computer Features

Topic	Page
Operating Systems	9
Computer Options	10
Hardware Features	11

The Allen-Bradley® VersaView® 5400 portfolio is a line of industrial computers that can be used for standalone machine-level and distributed HMI applications. The open architecture supports modern operating systems and various software applications, including FactoryTalk® software for distributed applications.

The VersaView 5400 integrated display computers have an edge-to-edge, all glass, ten-point multi-touch screen that can also be operated with gloves. The touch screens are precalibrated so that recalibration is not necessary.

The line is fanless with little maintenance needed, which helps reduce costly machine downtime.

All VersaView non-display computers perform the same as the integrated display computers, in a compact design that supports multiple mounting options.

Operating Systems

The following Microsoft®-licensed operating systems are available:

- Windows® 7 Professional (64 bit), SP 1
- Windows Embedded Standard (WES) 7 (64 bit)
- Windows 10 Internet of Things (IoT) Enterprise (64 bit)

No operating system updates have been applied to the factory image beyond the listed service packs.

To obtain a copy of a factory system image, contact your local technical support center or access the Rockwell Automation® PCDC site:

<https://compatibility.rockwellautomation.com/Pages/home.aspx>.

Computer Options

[Table 1](#) describes what options ship currently with VersaView 5400 industrial computers. To identify model configuration, compare the sticker on your model to [Table 1](#).

A comparative summary of features is in publication [IC-TD001](#), Industrial Computer and Monitors Specifications Technical Data.

Table 1 - VersaView 5400 Non-display and Integrated Display Computer Catalog Numbers

Cat. No.	Microsoft Windows OS (64 bit)	Industrial Computer Model	Display Size (in.)	Touch Screen	CPU Core	MLC SSD Storage Size (GB)
6200P-NS3A1	7 Pro, SP1	Non-display	—		Quad	128
6200P-NS3A1K ⁽¹⁾						
6200P-NS3B1	WES 7					
6200P-NS3B1K ⁽¹⁾						
6200P-NS3C1	10 IoT Enterprise					
6200P-NS3C1K ⁽¹⁾						
6200P-NS3C6	10 IoT Enterprise ⁽²⁾					
6200P-12WS3A1	7 Pro, SP1	Display	12.1	PCAP		
6200P-12WS3B1	WES 7					
6200P-12WS3C1	10 IoT Enterprise					
6200P-15WS3A1	7 Pro, SP1		15.6			
6200P-15WS3B1	WES 7					
6200P-15WS3C1	10 IoT Enterprise					
6200P-19WS3A1	7 Pro, SP1		18.5			
6200P-19WS3B1	WES 7					
6200P-19WS3C1	10 IoT Enterprise					
6200P-22WS3A1	7 Pro, SP1		21.5			
6200P-22WS3B1	WES 7					
6200P-22WS3C1	10 IoT Enterprise					

(1) These VersaView devices are conformal coated.

(2) This VersaView device ships with FactoryTalk® Analytics™ software installed. When accessed, that software runs in the Windows Kiosk mode, which limits the user's access to the operating system.

Hardware Features

The following figures show the hardware features of VersaView 5400 industrial non-display and integrated display models.

Figure 1 - VersaView 5400 Industrial Non-display Models (Cat. Nos. 6200P-NS3x1, 6200P-NS3x1K, and 6200P-NS3C6)

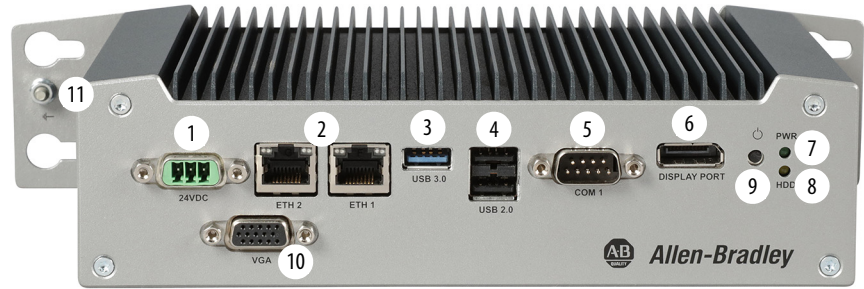

Item	Component
1	24V DC power input connection
2	2 x Ethernet LAN port
3	USB 3.0 port
4	2 x USB 2.0 port
5	Serial COM port, RS-232
6	DisplayPort ⁽¹⁾

Item	Component
7	Power LED
8	SSD LED
9	Power button
10	VGA port
11	Ground stud

(1) Audio output/line out supported.

Figure 2 - VersaView 5400 Industrial Integrated Display Models (Cat. Nos. 6200P-xxWS3x1)

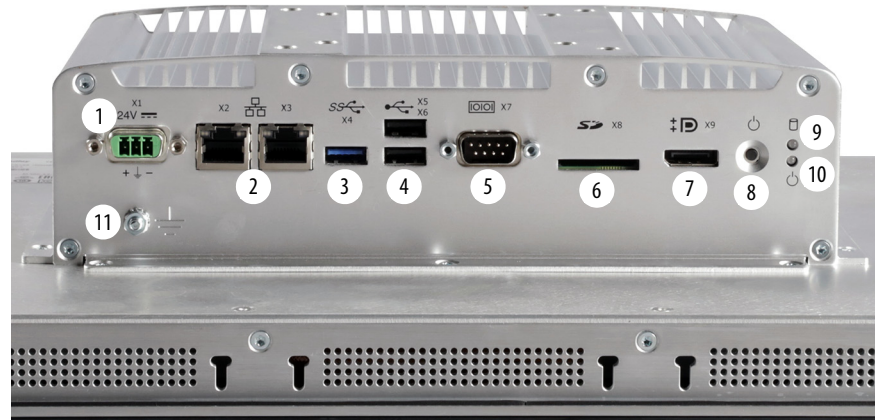

Item	Component
1	24V DC power input connection
2	2 x Ethernet LAN port
3	USB 3.0 port
4	2 x USB 2.0 port
5	Serial COM port, RS-232
6	SD card

Item	Component
7	DisplayPort ⁽¹⁾
8	Power button
9	SSD LED
10	Power LED
11	Ground stud

(1) Audio output/line out supported.

Notes:

VersaView 5200 ThinManager Thin Client Features

Topic	Page
Thin Client Options	13
Hardware Features	14

The Allen-Bradley® VersaView® 5200 ThinManager® thin clients work exclusively with ThinManager software for centrally-managed content delivery. Integrated display and non-display versions are available.

Thin Client Options

[Table 2](#) describes what options ship currently with VersaView 5200 thin clients. To identify your model's configuration, compare the sticker on your model to [Table 2](#).

A comparative summary of features is in publication [IC-TD001](#), Industrial Computer and Monitors Specifications Technical Data.

Table 2 - VersaView 5200 ThinManager Thin Client Non-display and Display Catalog Numbers

Cat. No.	Windows OS	Thin Client Model	Display Size (in.)	Touch Screen	CPU Core	MLC SSD Storage Size (GB)	No. of External Displays				
6200T-BA	—	Non-display	—		Single	—	1				
6200T-NA							2				
6200T-NAK ⁽¹⁾											
6200T-KB							2 ⁽²⁾				
6200T-RC					3 ⁽²⁾						
6200T-RE					7 ⁽²⁾						
6200T-12WA					Display		12.1	PCAP	Single		1
6200T-15WA											15.6
6200T-19WA											18.5
6200T-22WA											21.5

(1) This VersaView device is conformal coated.

(2) These external display ports support 4K resolution.

Hardware Features

The following figures show the hardware features of VersaView 5200 ThinManager thin client models.

Figure 3 - VersaView 5200 ThinManager Thin Client – Single Display (Cat. No. 6200T-BA)

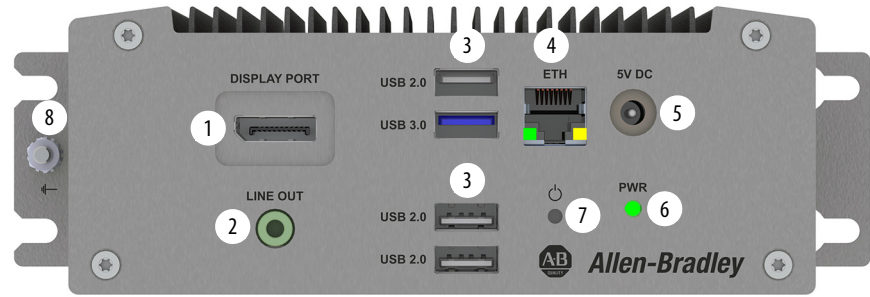

Item	Component
1	DisplayPort
2	Analog audio output
3	3 x USB 2.0 port and 1 x USB 3.0 port
4	Ethernet LAN port

Item	Component
5	5V DC power input connection
6	Power LED
7	Power button
8	Ground stud

Figure 4 - VersaView 5200 ThinManager Thin Client – Dual Display (Cat. Nos. 6200T-NA and 6200T-NAK)

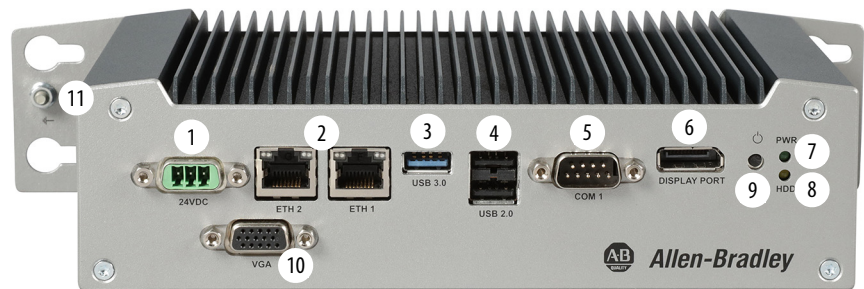

Item	Component
1	24V DC power input connection
2	2 x Ethernet LAN port
3	USB 3.0 port
4	2 x USB 2.0 port
5	Serial COM port, RS-232
6	DisplayPort ⁽¹⁾

Item	Component
7	Power LED
8	SSD LED
9	Power button
10	VGA port
11	Ground stud

(1) Audio output/line out supported.

Figure 5 - VersaView 5200 ThinManager Thin Client – Dual 4K Display (Cat. No. 6200T-KB)

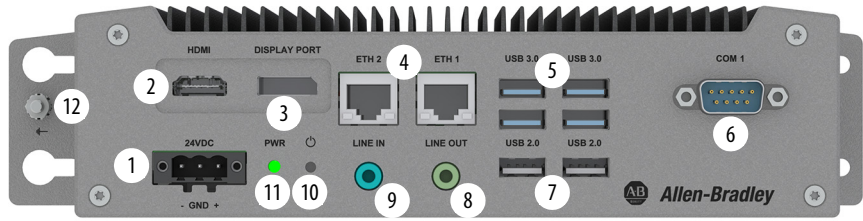

Item	Component
1	24V DC power input connection
2	HDMI port ⁽¹⁾
3	DisplayPort ⁽¹⁾
4	2 x Ethernet LAN port
5	4 x USB 3.0 port
6	Serial COM port, RS-232

Item	Component
7	2 x USB 2.0 port
8	Analog audio output
9	Analog audio input ⁽²⁾
10	Power button
11	Power LED
12	Ground stud

- (1) These ports support 4K resolution.
- (2) Audio input is not supported currently with ThinManager software.

Figure 6 - VersaView 5200 ThinManager Thin Client – Multi-4K Display (Cat. Nos. 6200T-RC and 6200T-RE)

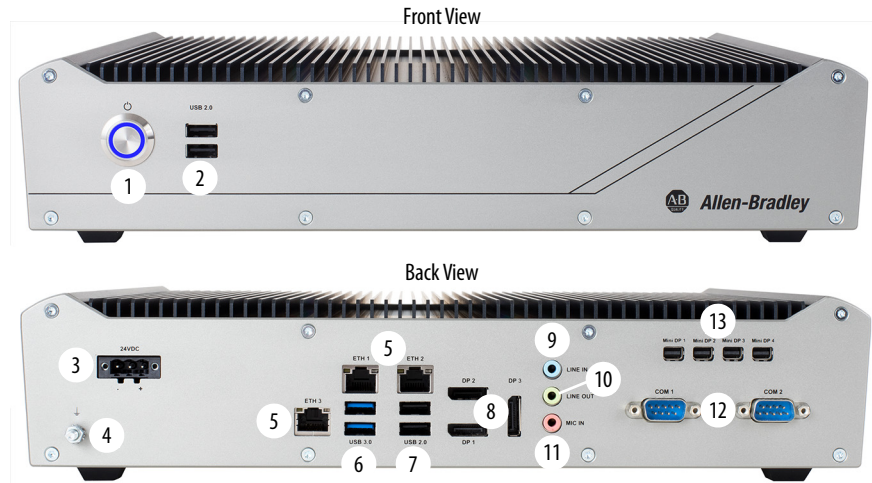

Item	Component
1	Power button ⁽¹⁾
2	2 x USB 2.0 port
3	24V DC power input connection
4	Ground stud
5	3 x Ethernet LAN port
6	2 x USB 3.0 port
7	2 x USB 2.0 port

Item	Component
8	3 x full-sized DisplayPort ⁽²⁾
9	Analog audio input ⁽³⁾
10	Analog audio output
11	Microphone input ⁽³⁾
12	2 x Serial COM port, RS-232
13	4 x Mini DisplayPort ⁽²⁾⁽⁴⁾

- (1) Button has a LED ring that is lit when power is on, which is shown in picture.
- (2) These ports support 4K resolution.
- (3) Audio input is not supported currently with ThinManager software.
- (4) Only Cat. No. 6200T-RE includes these four mini display ports; Cat. No. 6200T-RC does not.

Figure 7 - VersaView 5200 ThinManager Thin Client Integrated Display Models (Cat. Nos. 6200T-xxWA)

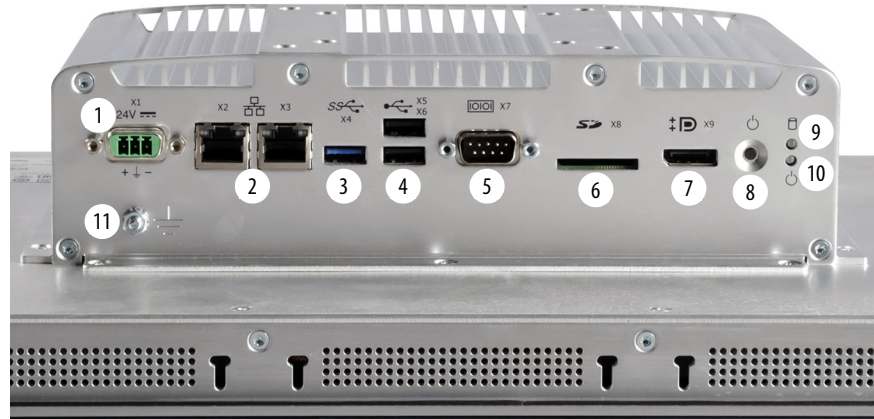

Item	Component
1	24V DC power input connection
2	2 x Ethernet LAN port
3	USB 3.0 port
4	2 x USB 2.0 port
5	Serial COM port, RS-232
6	SD card

Item	Component
7	DisplayPort ⁽¹⁾
8	Power button
9	SSD LED
10	Power LED
11	Ground stud

(1) Audio output/line out supported.

Install the Thin Client or Computer

Topic	Page
Before You Begin	17
Parts List	17
Installation Precautions	18
Hazardous Location Categories	19
Mounting Clearance Requirements	22
Dimensions	23
Required Tools	25
Install the Thin Client or Computer	25
Connect Peripherals	29
Connect Power	31

Before You Begin

Before you unpack your VersaView® 5000 ThinManager® thin client or industrial computer, inspect the shipping carton for damage. If damage is visible, immediately contact the shipper and request assistance. Otherwise, proceed with unpacking.

Keep the original packing material in case you need to return the VersaView thin client or computer for repair or transport it to another location. Use both the inner and outer packing cartons to provide adequate protection for equipment returned for service.

Parts List

VersaView thin clients or computers ship with the following items.

Item	Description
Hardware	<ul style="list-style-type: none"> • Mounting clips⁽¹⁾ • DC terminal block⁽²⁾ • AC-to-DC power adapter, Cat. No. 6200V-MPS5⁽³⁾ • Four rubber mount pads⁽⁴⁾⁽⁵⁾
Documents	<ul style="list-style-type: none"> • VersaView 5100 Industrial Monitors, VersaView 5000 Thin Clients, Industrial Computers, and Accessories Product Information, publication 6200-PC001 • VersaView 5000 Thin Clients, Industrial Computers, and Accessories for Hazardous Locations Installation Instructions, publication 6200-IN001⁽⁶⁾ • VersaView 5000 Thin Client and Integrated Display Industrial Computers Cutout Template, publication 6200-DS001⁽¹⁾

(1) Shipped only with VersaView thin client and industrial computers with integrated display models.

(2) DC terminal block does not ship with the Cat. No. 6200T-BA ThinManager thin client model.

(3) Shipped only with the Cat. No. 6200T-BA ThinManager thin client model.

(4) Shipped only with non-display industrial computers and non-display ThinManager thin client models.

(5) Although supplied, the four pads cannot be used as a mounting method for VersaView devices meant for hazardous locations.

(6) This publication ships only with VersaView 5000 thin client and industrial computers for hazardous locations.

Installation Precautions

Read and follow these precautions before you install your VersaView thin client or industrial computer.

Environment and Enclosure Information



ATTENTION: This equipment is intended for use in a Pollution Degree 2 industrial environment, in overvoltage Category II applications (as defined in IEC 60664-1), at altitudes up to 2000 m (6561 ft) without derating.

This equipment is UL Listed, and considered Group 1, Class A industrial equipment according to IEC/CISPR 32. Without appropriate precautions, there can be potential difficulties with electromagnetic compatibility in other environments due to conducted and radiated disturbance.

All VersaView integrated display thin clients and industrial computers are shipped with a gasketed bezel to meet specified NEMA, UL Type, and IEC IP ratings only when mounted in a panel or enclosure with an equivalent rating.

This paragraph applies only to VersaView devices for hazardous locations:

This equipment is supplied as an open type equipment. To meet some regulatory requirements, the equipment must be mounted in an enclosure that is suitably designed for environmental conditions that can be present and appropriately designed to help prevent personal injury resulting from accessibility to live parts. The interior of the enclosure must be accessible only by using a tool.

In addition to this publication, see the following:

- Industrial Automation Wiring and Grounding Guidelines, publication [1770-4.1](#), for more installation requirements
 - NEMA 250 and IEC 60529, as applicable, for explanations of the degrees of protection provided by enclosures
-

European Union Directive

VersaView 5000 ThinManager thin client and industrial computers meet the European Union Directive requirements when installed within the European Union or EEA regions and have the CE marking. A copy of the declaration of the conformity is available at [Product Certifications website](#).



ATTENTION: This equipment is intended to operate in an industrial or control room environment, which uses some form of power isolation from the public low-voltage mains.

To comply with EN 55024 and EN 55032, all cables, except for Ethernet cables, must be used indoors. These cables cannot exit the building at any point and cannot directly connect to cables outside the building. All I/O cables, except for Ethernet cables and serial port (COM) cables, must be less than 3 m (9.842 ft).

To comply with EN 55024 and EN 55032, use the following for cable types.

Cable Type	Required Attribute	Cable Type	Required Attribute
LAN	Shielded	Line out	Unshielded
USB		Line in	
Serial RS-232		Microphone	
DVI		DC power	
DisplayPort		AC power	Unshielded ⁽¹⁾
Mini-DisplayPort			
HDMI			
VGA			

(1) For the applicable power adapters, see the Power Connection table rows in [Connect Peripherals on page 29](#).

Installation Precautions for VersaView Devices for Hazardous Locations

The following three subsections apply only to VersaView devices for hazardous locations. The affected catalog numbers are listed in the following table.

Hazardous Location Categories

VersaView devices for hazardous locations are suitable for these location categories.

Cat. Nos. ⁽¹⁾	Region	Rating	Temperature Range
6200P-NS3A1, 6200P-NS3A1K, 6200P-NS3B1, 6200P-NS3B1K, 6200P-NS3C1, 6200P-NS3C1K, 6200P-NS3C6, 6200T-NA, 6200T-NAK	United States	Class I Division 2, Groups A, B, C, DT4 Class I Zone 2, IIC, T4	-20 °C ≤ T _a ≤ +60 °C ⁽²⁾ (-4 °F ≤ T _a ≤ +140 °F)
	Canada	Class I Division 2, Groups A, B, C, DT4 Class I Zone 2, IIC, T4	
	Europe (ATEX)	 II 3 G, Ex ec IIC T4 Gc, DEMKO 19 ATEX 2252 X	

(1) Conditions for Safe Use

- The following applies to VersaView 5000 thin client and industrial computers for hazardous locations:
- The equipment shall only be used in an area of not more than Pollution Degree 2, as defined in EN 60664-1.
 - The equipment shall be installed in a tool-only accessible enclosure that provides a degree of protection not less than IP54 in accordance with EN 60079-0.
 - Transient protection shall be provided that is set at a level not exceeding 140% of the peak rated voltage value at the supply terminals to the equipment.
 - The internal enclosure ambient temperature range is -20...+60 °C (-4...+140 °F).
- (2) These ThinManager thin client and industrial computers for hazardous locations are required to be mounted in a restricted access location.

The following statement applies to when the VersaView device for hazardous locations is used in a hazardous location.



WARNING: Explosion Hazard

- Substitution of components can impair suitability for hazardous locations.
 - Do not disconnect equipment unless power has been switched off and the area is known to be non-hazardous.
 - Do not connect or disconnect components unless power has been switched off.
 - Use only peripheral equipment that is suitable for hazardous locations. For a list of suitable peripheral equipment, see the table in [Connect Peripherals on page 29](#).
 - In the U.S., all wiring must be in accordance with Class I, Division 2 wiring methods of Article 501 of the National Electrical Code, and in accordance with the authority having jurisdiction. For power wiring requirements, see the table in [Installation Guidelines on page 21](#).
 - In Canada, all wiring must be in accordance with Section 18-1J2 of the Canadian Electrical Code, and in accordance with the authority having jurisdiction. For power wiring requirements, see the table in [Installation Guidelines on page 21](#).
 - In final applications, properly connect these devices to ground by using the ground terminal screw on the device chassis, the ground screw on the factory installed mounting bracket, or the ground terminal on the terminal block.
-

Restricted Access Location



ATTENTION: VersaView 5000 devices for hazardous locations must be installed in a restricted access location.

Verify that restricted access locations meet these conditions for the VersaView 5000 devices for hazardous locations:

- Access is gained only by service personnel or by users who have been instructed on the reasons for restrictions to a location and about any precautions to be taken.
- Access is by using a tool, a lock and key, or other means of security controlled by the authority responsible for the location.

Installation Guidelines

Follow these guidelines to make sure your VersaView thin client or industrial computer provides service with excellent reliability:

- The installation site must have sufficient power.



ATTENTION: For applications with an AC power source, the shipped or optional AC-to-DC power adapter must be plugged into a grounded outlet to maintain an electrically safe installation.

An AC power supply cannot be used in a hazardous location.

- Verify that the DC power wires meet these requirements:

Attribute	Requirement
Wire material	Stranded copper
Wire gauge <ul style="list-style-type: none"> • To connect to DC terminal block • To connect to earth ground 	<ul style="list-style-type: none"> • 0.326...3.31 mm² (22...12 AWG) • 1.5 mm² (16 AWG) or larger
Wire temperature rating, min	72° C (162° F)
Torque values <ul style="list-style-type: none"> • To connect wires to DC terminal block • To connect to earth ground⁽¹⁾ 	<ul style="list-style-type: none"> • 0.22...0.25 N•m (1.95...2.21 lb•in) • 3.1 N•m (2.29 lb•in)

(1) On either computer chassis or factory-installed bookshelf mounting bracket.

- In dry environments, static charges can build up easily. Proper grounding of the thin client or computer helps to reduce static discharges, which can cause shock and damage electronic components.
- The ambient air temperature must not exceed the maximum operating temperature in [Table 3](#).

Table 3 - Maximum Operating Temperature Ranges

VersaView Model		Cat. Nos.	Temperature, max
5200 ThinManager thin client	Non-display	6200T-BA	0...50 °C (32...122 °F)
		6200T-KB	0...55 °C (32...131 °F)
		6200T-RC, 6200T-RE	0...45 °C (32...113 °F)
		6200T-NA, 6200T-NAK	-20...+60 °C (-4...+140 °F)
	Display	6200T-xxWA	0...50 °C (32...122 °F)
5400 Industrial Computers	Non-display	6200P-NSxA1, 6200P-NSxA1K, 6200P-NS3C6	-20...+60 °C (-4...+140 °F)
	Display	6200P-xxWS3x1	0...50 °C (32...122 °F)

IMPORTANT VersaView thin clients and industrial computers can operate at a range of extremes. However, the life span of any electronic device is shortened if you continuously operate it at its highest rated temperature, which includes the touch screen and LCD panel.

- The humidity of the ambient air must not exceed the following limits:

VersaView Model		Cat. Nos.	Humidity, max (noncondensing)
5200 ThinManager thin client	Non-display	6200T-BA	90% at 50 °C (122 °F)
		6200T-KB	90% at 55 °C (122 °F)
		6200T-RC, 6200T-RE	90% at 40 °C (104 °F)
		6200T-NA, 6200T-NAK	95% at 40 °C (104 °F)
	Display	6200T-xxWA	93% at 40 °C (104 °F)
5400 Industrial Computers	Non-display	6200P-NSxA1, 6200P-NSxA1K, 6200P-NS3C6	95% at 40 °C (104 °F)
	Display	6200P-xxWS3x1	93% at 40 °C (104 °F)

- The thin client or computer cover must always remain in place during operation. The cover provides protection against high voltages inside the VersaView device and inhibits radio frequency emissions that can interfere with other equipment.

Enclosure Guidelines

- The enclosure must allow sufficient space around air inlets and outlets to provide the circulation necessary for cooling. See [Mounting Clearance Requirements on page 22](#) for further information. Never allow air passages to become obstructed.
- Hot air rises. The temperature at the top of the enclosure is often higher than the temperature in other parts of the enclosure, especially if air is not circulating.

Consider a user-supplied fan, heat exchanger, or air conditioner for heat generated by other devices in the enclosure. See [Hazardous Location Categories on page 19](#) for the acceptable temperature ranges for these computers.

Mounting Clearance Requirements

To help prevent overheating and to provide access to the thin client or computer I/O ports for cable connections, leave at least 5 cm (2 in.) of free space around the device.

Do not obstruct the air intake, exhaust openings, or cooling fins of the thin client or computer cover.

IMPORTANT VersaView thin clients and industrial computers generate heat. Therefore, do not operate either device in an enclosure with the minimum clearances unless adequate ventilation or other cooling methods are used to lower the temperature within the enclosure.

Dimensions

Review the following dimensions to estimate the clearance necessary to install your thin client or computer. Dimensions are given in mm (in.).

Figure 8 - Dimensions for Non-display Models

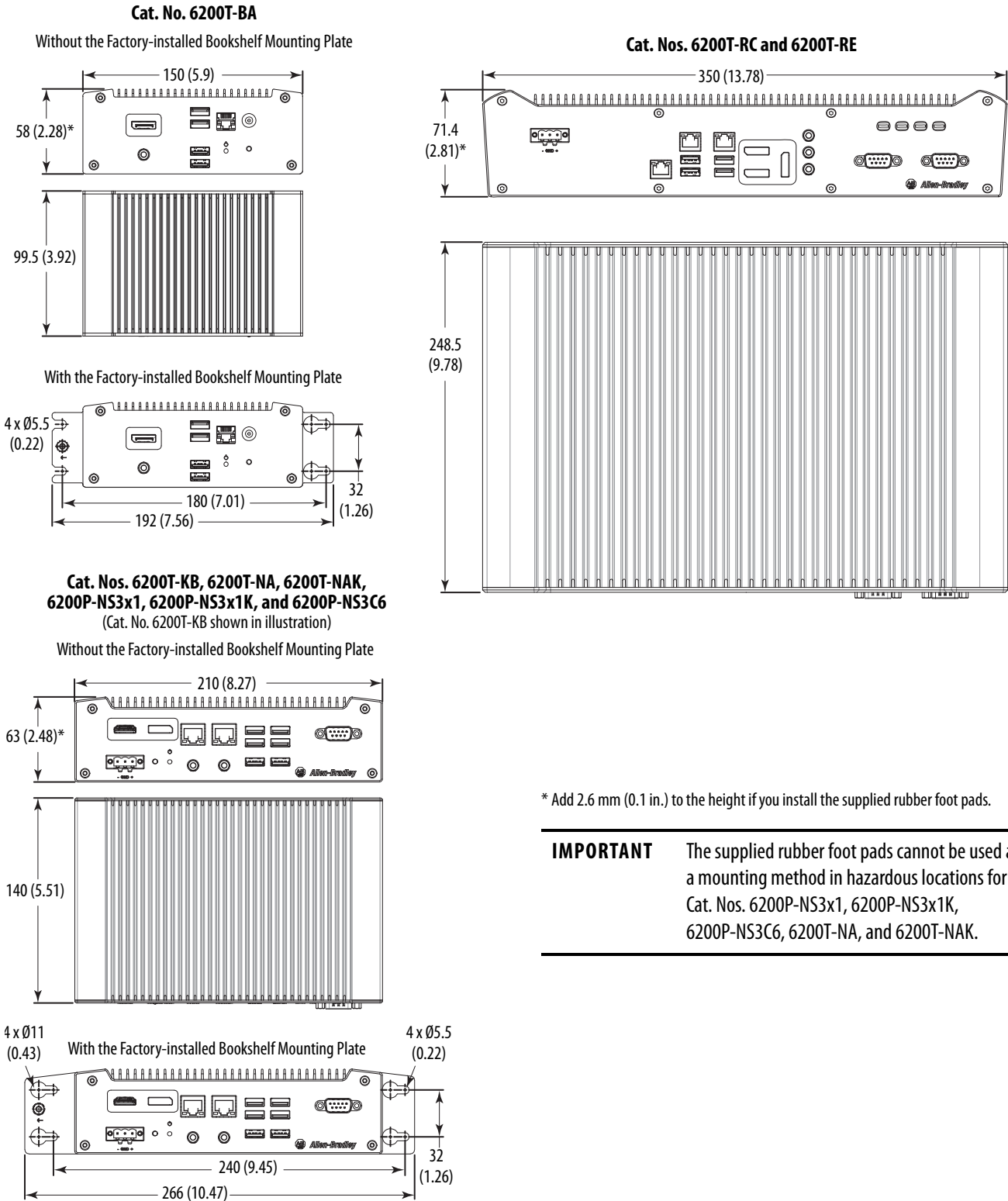

* Add 2.6 mm (0.1 in.) to the height if you install the supplied rubber foot pads.

IMPORTANT The supplied rubber foot pads cannot be used as a mounting method in hazardous locations for Cat. Nos. 6200P-NS3x1, 6200P-NS3x1K, 6200P-NS3C6, 6200T-NA, and 6200T-NAK.

Figure 9 - Dimensions for Integrated Display Models

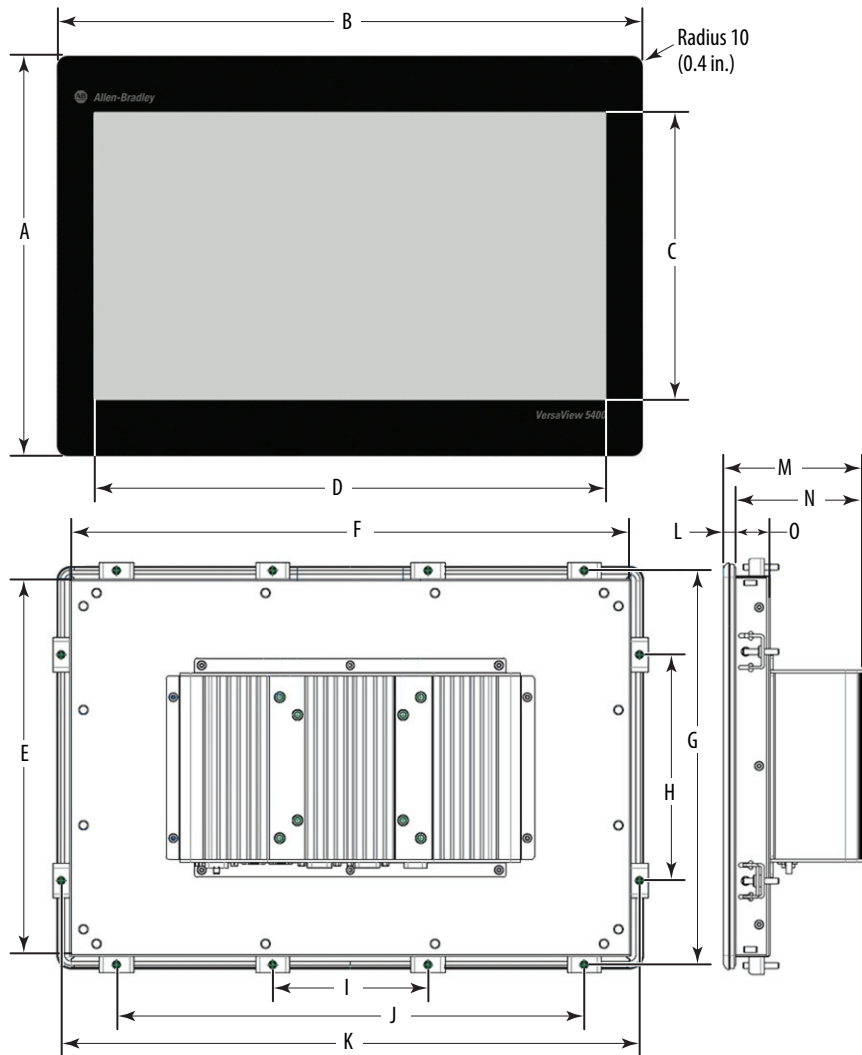

Cat. Nos.	Display Size (in.)	Dimensions, mm (in.)														
		A	B	C	D	E	F	G	H	I	J	K	L ⁽¹⁾	M ⁽²⁾	N	O
6200P-12WS3x1, 6200T-12WA	12.1	266 (10.47)	328 (12.91)	163.2 (6.43)	261 (10.28)	248 (9.76)	310 (12.2)	260 (10.24)	125 (4.92)	200 (7.87)	—	322.5 (12.7)	7.6 (0.3)	97.1 (3.82)	89.5 (3.52)	24.5 (0.97)
6200P-15WS3x1, 6200T-15WA	15.6	298 (11.73)	414 (16.3)	193.5 (7.61)	344.2 (13.55)	280 (11)	396 (15.6)	292 (11.5)	160 (6.3)	110 (4.33)	330 (13)	408 (16)				
6200P-19WS3x1, 6200T-19WA	18.5	337 (13.27)	480 (18.9)	230 (9.07)	410 (16.13)	319 (12.56)	462 (18.19)	331 (13.03)	250 (9.84)	130 (5.12)	390 (15.35)	474 (18.66)				
6200P-22WS3x1, 6200T-22WA	21.5	373 (14.68)	545 (21.46)	268 (10.55)	476.6 (18.76)	355 (14)	527 (20.75)	367 (14.45)	250 (9.84)	150 (5.91)	450 (17.71)	539 (21.22)				

(1) Metric dimension is ±0.5, and the English dimension is ±0.02.

(2) Metric dimension is ±1.0, and the English dimension is ±0.04.

Required Tools

These tools are required to install all VersaView 5000 models:

- #2 cross-head screwdriver
- Panel cutout tools (for wall and panel mounting)
- 2 mm Allen wrench (for mounting clips on integrated display models)
- Drill motor and drill bit (for wall, machine, and table mounting)
- T10 Torx key or screwdriver (to install optional brackets)
- Anti-static wriststrap

Install the Thin Client or Computer

The computers support the following mounting options:

- Panel mount (for integrated display models)
- Wall mount (for non-display models)

TIP All non-display models ship with a factory-installed mounting plate for wall mounting, except for Cat. Nos. 6200T-RC and 6200T-RE. Instructions for other available mounting plates and mounting options are detailed in Appendix A, [Install Accessories](#), starting on [page 53](#).

Panel Mounting Guidelines

Observe these guidelines when you install an integrated display thin client or computer in a panel.



ATTENTION: Failure to follow these guidelines can result in personal injury or damage to the panel components.

- Remove all electrical power from the panel before you make the cutout.
- Confirm that there is adequate space behind the panel. For specific information, refer to [Mounting Clearance Requirements](#) on [page 22](#).
- Cut supporting panels to specifications before installation. Take precautions so metal cuttings do not enter components already installed in panel.

The supplied mounting hardware accommodates panel thickness between 1.5...6 mm (0.06...0.24 in.).

- Make sure the area around the panel cutout is clear.
- The only acceptable mounting position is in the horizontal position with the I/O ports at the bottom.
- For VESA mounting of non-display thin clients or computers, the installation must provide sufficient mechanical stability to minimize the effects from vibration and shock. The mounting means must be firmly attached to the supporting surface with the appropriate hardware.

IMPORTANT VESA mounting reduces the computer IP rating from IP65 to IP20.

Panel Cutout Dimensions

The VersaView 5000 Cutout Template, publication [6200-DS001](#), is shipped with all VersaView 5000 integrated display thin client or computer models.

All integrated display thin client or computer models must be mounted to meet these panel cutout dimensions.

Display Size (in.)	Cutout Dimensions (H x W), approx.
12.1	250 x 312 mm (9.84 x 12.28 in.)
15.6	282 x 398 mm (11.1 x 15.67 in.)
18.5	321 x 464 mm (12.64 x 18.27 in.)
21.5	357 x 529 mm (14.06 x 20.83 in.)

Mount an Integrated Display Model in a Panel

Mounting clips secure an integrated display model to the panel. The number of clips varies by model.

Display Size (in.)	Clips (qty.)	Cat. No.	Description
12.1	8	6200V-MCLPS4	Replacement mounting clips (14)
15.6	12		
18.5	14		
21.5			

Follow these steps to mount an integrated display model in a panel.

1. Remove power from the panel.
2. Verify that the panel surface around the area to be cut is clean and free of debris.



ATTENTION: Take precautions so metal fragments do not enter components already installed in the panel to avoid personal injury or damage to the panel components.

3. Cut an opening in the panel by using the appropriate panel cutout dimensions.
4. Attach cables to the integrated display model before installation if rear access to the model is limited after installation.

For where to attach cables, see [Connect Peripherals on page 29](#).

5. Make sure the sealing gasket is properly positioned on the integrated display model.

This gasket forms a compression-type seal. Do not use sealing compounds.

6. Place the integrated display model in the panel cutout.

7. Slide the mounting clips into the holes on the top, bottom, and sides of the integrated display model.
8. Hand-tighten the mounting clips around the bezel by following the tighten sequence in [Figure 10](#).
9. Repeat this process at least three times until the clips are hand-tight and the gasket is compressed uniformly against the panel.
10. With a 2 mm Allen wrench, tighten the mounting clips to a torque of $0.4 \text{ N}\cdot\text{m}$ ($3.5 \text{ lb}\cdot\text{in}$) by following the torque sequence in [Figure 10](#). Do not overtighten.
11. Repeat this process at least three times until the clips are properly torqued to $0.7 \text{ N}\cdot\text{m}$ ($6.2 \text{ lb}\cdot\text{in}$). Verify that the gasket is compressed uniformly against the panel.



ATTENTION: Tighten the mounting clips to the specified torque to provide a proper seal and to help prevent product damage. Rockwell Automation assumes no responsibility for water or chemical damage to the integrated display model or other equipment within the enclosure because of improper installation.

Figure 10 - Tightening and Torquing Sequence for Mounting Clips

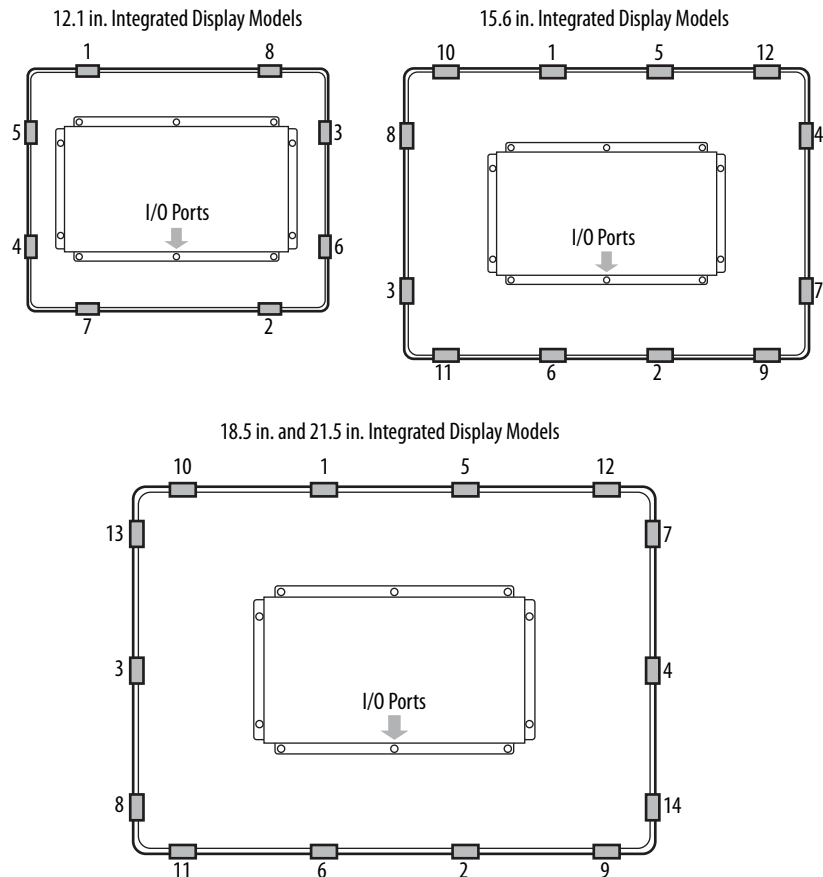

VESA Mounting

You can use an optional bench/tabletop adapter to mount a VersaView 5000 thin client or industrial computer on a bench or tabletop.

For installation instructions, see [Install the VESA Mounting Plate \(Cat. No. 6200V-BXVESA\) on page 56.](#)

IMPORTANT If you choose to VESA mount an integrated display model, its IP rating is reduced from IP65 to IP20.

Mount a Non-display Model

Follow these steps to mount a VersaView 5000 non-display model.

IMPORTANT Depending on the bracket, certain restrictions apply when you mount a non-display model. See [Figure 11](#) for details.

For other available non-display mounting brackets and their orientations, see [Appendix A](#).

1. Verify that the power is disconnected.
2. Depending on your application, drill holes to accommodate customer-supplied M5 pan head screws.

See [Figure 8 on page 23](#) for mounting hole locations and dimensions.
3. Mount the non-display model by using four customer-supplied M5 pan head screws.

Tighten to a torque that is appropriate for the screw and material.

Figure 11 - Acceptable and Unacceptable Mounting Positions for All Non-display VersaView Thin Clients and Industrial Computer Models

Cat. No. 6200T-NA shown for illustrative purposes.

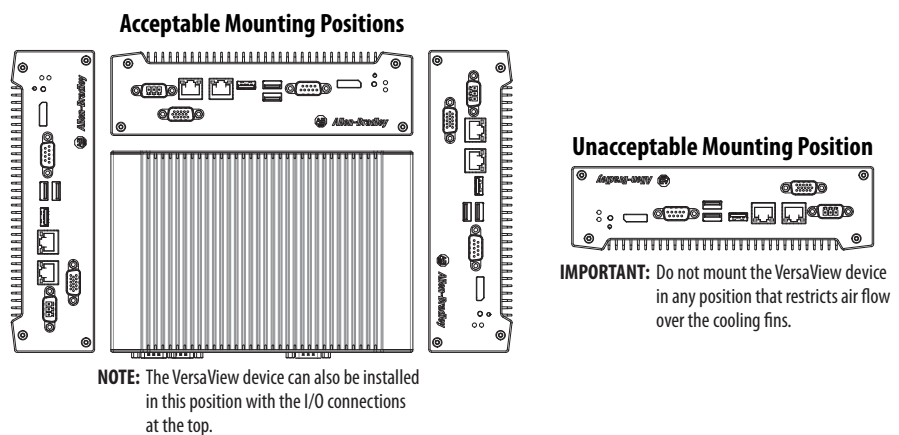

Connect Peripherals

See Hardware Features on [page 11](#) or [page 14](#) for what ports are available to connect peripherals. Use the table below for accessories to connect peripherals to VersaView 5000 thin clients or industrial computers.

IMPORTANT For optimal performance, use only Rockwell Automation-approved active DisplayPort adapters.

Table 4 - Available Accessories for VersaView Thin Clients and Industrial Computers

Category	Cat. No.	Description	Cat. Nos. Per Location Type	
			Non-hazardous Only	Non-hazardous and Hazardous ⁽²⁾
Mounting hardware	6200V-BXDIN	DIN rail mounting kit	6200T-KB	6200P-NS3x1 6200P-NS3x1K 6200P-NS3C6 6200T-NA 6200T-NAK
	6200V-BXDIN2	DIN rail mounting kit	6200T-BA	—
	6200V-BXLGCY	Legacy mounting plate	6200T-KB	6200P-NS3x1 6200P-NS3x1K 6200P-NS3C6 6200T-NA 6200T-NAK
	6200V-BXMACH	Machine mounting bracket	6200T-KB	6200P-NS3x1 6200P-NS3x1K 6200P-NS3C6 6200T-NA 6200T-NAK
	6200V-BXMACH2	Machine mounting bracket for ThinManager thin client multi-4K display models	6200T-RC 6200T-RE	—
	6200V-BXVESA	VESA mounting plate	6200T-KB	6200P-NS3x1 6200P-NS3x1K 6200P-NS3C6 6200T-NA 6200T-NAK
	6200V-BXVESA2	VESA mounting plate	6200T-BA	—
	6200V-BXWALL	Bookshelf mounting plate	6200T-KB	6200P-NS3x1 6200P-NS3x1K 6200P-NS3C6 6200T-NA 6200T-NAK
	6200V-BXWALL2	Bookshelf mounting plate	6200T-BA	—
Cables, adapters, and I/O accessories	6200V-DPVGA2	DisplayPort to VGA active adapter	All	6200P-NS3x1 6200P-NS3x1K 6200P-NS3C6 6200T-NA 6200T-NAK
	6200V-DPDVI2	DisplayPort to DVI-D active adapter		
	6200V-DPHDMI4K	DisplayPort to HDMI active adapter		
	6200V-DPCBL2M	DisplayPort to DisplayPort cable, 2 m (6.5 ft) long		
	6200V-DVICBL2M	DVI-D to DVI-D cable, 2 m (6.5 ft) long		
	6200V-MDP2HDMI4K	Mini DisplayPort to HDMI adapter	6200T-RC 6200T-RE	—
	6200V-MDP2DP	Mini DisplayPort to DisplayPort adapter		
	6200V-PLUGS	Protective I/O port dust caps	All	6200P-NS3x1 6200P-NS3x1K 6200P-NS3C6 6200T-NA 6200T-NAK
	6200V-VGACBL2M	VGA to VGA cable, 2 m (6.5 ft) long		
	6200V-USBCBL2M	USB to USB touch screen cable, 2 m (6.5 ft) long		

Table 4 - Available Accessories for VersaView Thin Clients and Industrial Computers (continued)

Category	Cat. No.	Description	Cat. Nos. Per Location Type	
			Non-hazardous Only	Non-hazardous and Hazardous ⁽²⁾
Power connection	6200V-MPS4	AC to 90 W, 24V DC power adapter ⁽¹⁾	All except 6200T-BA	—
	6200V-MPS5	Replacement AC to DC power adapter ⁽¹⁾	6200T-BA	—
	6200V-MPS6	AC to 40 W, 24V DC power adapter ⁽¹⁾	6200T-KB	—
	6200V-DCCONN	DC power mating connector housing kit	All except 6200T-BA 6200T-KB 6200T-RC 6200T-RE	6200P-NS3x1 6200P-NS3x1K 6200P-NS3C6 6200T-NA 6200T-NAK
	6200V-DCCONN2	Replacement DC terminal block	6200T-KB 6200T-RC 6200T-RE	—

- (1) Power adapters ship with a power cord that has an IEC 60320 C14 receptacle and a NEMA 5-15P three-prong plug for North American applications. Any IEC 60320 C13 power cord can be used for other international applications.
- (2) Certain conditions apply; see the Arc Flash Hazard table on [page 30](#).



ARC FLASH HAZARD: Do not connect or disconnect any accessories to VersaView 5000 devices for hazardous locations unless power has been switched off and the area is known to be non-hazardous.

Before power is switched on, verify that any adapter, cable, or power connection accessory is fully inserted in its port. For adapter and cable accessories, verify that latches are engaged, and any screws are fully engaged and tightened.

Failure to do so could result in an electric arc that can cause an explosion in a hazardous location.

Protective I/O Port Dust Caps, Cat. No. 6200V-PLUGS

Protective I/O port dust caps are for hazardous locations where airborne chemicals or other particulates can damage exposed I/O ports and subsequently affect their reliability. An ordered kit supplies dust caps for each I/O port as detailed in [Figure 1 on page 11](#) or [Figure 4 on page 14](#).

The four VersaView 5000 models with conformal coating (Cat. Nos. 6200P-NS3A1K, 6200P-NS3B1K, 6200P-NS3C1K, and 6200T-NAK) are shipped with these protective I/O dust caps installed.

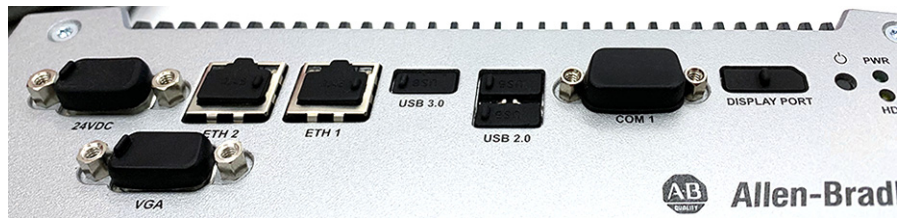

Connect Power

VersaView 5000 thin clients and industrial computers are factory shipped to be connected to a 24V DC power source, except for the 6200T-BA VersaView ThinManager thin client model, which uses an included AC to 5V DC adapter. For applications with an AC power source, see [AC Power Options on page 33](#).



ATTENTION: When you connect power to the thin client or computer for the first time, these actions occur:

- The default UEFI setting automatically starts the computer after it is plugged into a power source.
- For VersaView 5400 industrial computers with a Windows operating system (OS), you must read and accept an End User Setup procedure.

Do not disconnect power from the system until after the Windows Setup procedure is completed. If power is disconnected during this procedure, it can result in a corrupted system image.

Operate the VersaView thin client or industrial computer in an industrial or control room environment, which uses some form of power isolation from the public low-voltage mains.



ATTENTION: For VersaView 5400 industrial computers with a Windows OS, perform the following:

- Supply the computer circuit with its own disconnect. Use an uninterruptible power source (UPS) to help protect against unexpected power failure or power surges.
- Always shut down the Windows OS before you disconnect power to the computer to minimize performance degradation and operating system failures.

Connect DC Power

IMPORTANT This section does not apply to the Cat. No. 6200T-BA thin client single display model, which is supplied with an AC to 5V DC power adapter and cord.

All VersaView DC power models require a safety extra low voltage (SELV)⁽¹⁾ power supply per UL. A limited power source (LPS) rated power supply is also acceptable on some VersaView models. To determine if your model is LPS rated, see the product label.

VersaView 5400 computers, 5200 thin clients, and 5100 monitors are designed such that the DC input (-) is internally connected to the chassis ground.

To minimize ground loop currents and noise, Allen-Bradley recommends that DC powered models use only one grounded connection. On non-display thin clients and computers with bookshelf mounting brackets, a ground screw is on one end of the bracket. Integrated display thin clients and computers have a ground stud on the computer base. See [Hardware Features on page 11](#) or starting on [page 14](#) for ground screw locations.

The power supply is internally protected against reverse polarity.

(1) Where SELV is as defined in IEC 61010-2-201

Follow these steps to connect the thin client or computer to a DC power source.

TIP The following steps are to wire and attach DC terminal blocks that are supplied (shown in photos 2 and 4 on this page). The optional DC connector shown at right, Cat. No. 6200V-DCCONN, can be used instead of the DC terminal block.

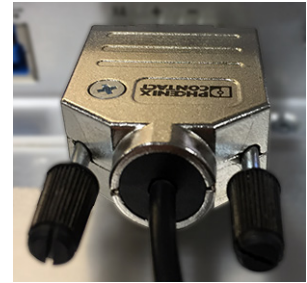

1. Turn off the main power switch or breaker.
2. Verify that the DC power wires meet these requirements listed in [Installation Guidelines on page 21](#).
3. Insert each DC power wire into the correct terminal on the supplied DC terminal block.

See the DC power input connector on the bottom of the thin client or computer for which wires to connect to the DC terminal block.

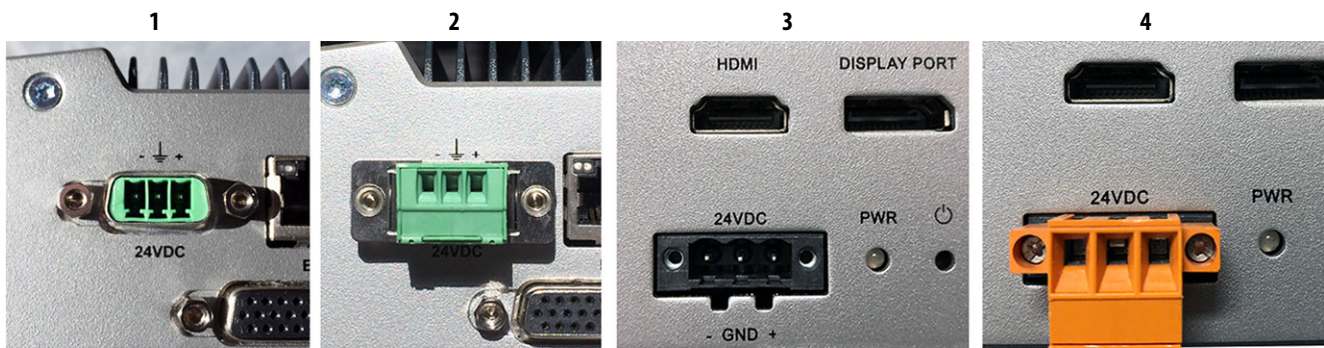

Non-display Computer or Thin Client Models (above)⁽¹⁾
 Photo 1 is the DC power input connector on the bottom of Cat. Nos. 6200P-NS3x1, 6200P-NS3x1K, 6200P-NS3C6, 6200T-NA, and 6200T-NAK. Photo 2 is the supplied DC terminal block installed in the same DC power input connector (shown without wires connected).

Photo 3 is the DC power input connector on the bottom of Cat. Nos. 6200T-KB, 6200T-RC, and 6200T-RE. Photo 4 is the supplied DC terminal block installed in the same DC power input connector (shown without wires connected).

Integrated Display Computer or thin client Models (at right)
 Photo 5 is the DC power input connector on the bottom of **all** integrated display thin client or computer models. Photo 6 is the supplied DC terminal block installed in the DC power input connector (shown without wires connected).

4. Torque each power wire to the values in the table in [Installation Guidelines on page 21](#).
5. Connect the DC terminal block to the DC power input.
6. Connect the thin client or computer to earth ground with a ground wire that meets the requirements in the table in [Installation Guidelines on page 21](#).

Use a ground wire with an insulation color that is approved by local inspection authority.

TIP Integrated display thin clients and computers have a ground stud on the computer base. See [page 11](#) or [page 14](#) for its location.

On non-display thin clients and computers with bookshelf mounting brackets, a ground screw is on one end of the bracket, as shown at right.

Use this ground screw to connect the thin client or computer to earth ground.

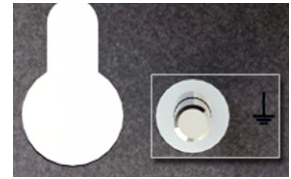

7. Apply 24V DC power to the thin client or computer.

AC Power Options

The following options are available to convert AC to 24V DC power for VersaView 5000 thin clients or industrial computers, except for the 6200T-BA thin client single display model⁽¹⁾. These options must be ordered separately.

- An AC to 90 W, 24V DC power adapter and power cord (Cat. No. 6200V-MPS4)⁽²⁾
- An AC to 40 W, 24V DC power adapter and power cord (Cat. No. 6200V-MPS6)⁽²⁾
- Allen-Bradley® switched mode power supplies:
<https://ab.rockwellautomation.com/Power-Supplies/Switched-Mode-Power-Supplies>

Both power adapters ship with a power cord that has an IEC 60320 C14 receptacle and a standard NEMA 5-15P three-prong plug for use in North America. Any IEC 60320 C13 power cord can be used for other international applications.

Follow these steps to connect a separately purchased AC to DC power adapter to an AC power source.

1. Connect the AC to DC power adapter to the DC power input on the computer. See Hardware Features on [page 11](#) or [page 14](#) for the DC power input location.
2. Connect the receptacle end of the power cord to the power adapter.
3. Connect the three-prong plug end of the power cord to an AC power source.



SHOCK HAZARD: Connect the power cord to an AC power source with an earth ground. Failure to follow this warning can result in electrical shock.

(1) The 6200T-BA thin client model is supplied with an AC to 5V DC power adapter and cord. To order a replacement, see [Connect Peripherals on page 29](#).

(2) See [Connect Peripherals on page 29](#) for which VersaView models work with each power adapter.

Notes:

Operate the Thin Client or Computer

Topic	Page
Operating Guidelines	35
Touch Screen Precautions	36
Start the Thin Client or Computer	36
Restart the Thin Client or Computer	38
Shut Down the Thin Client or Computer	38

Operating Guidelines

Follow these operating guidelines for your VersaView® thin client or computer:

- When the thin client or computer is panel mounted, operator access is limited to the front of the thin client or computer, which includes the display and the touch screen.

IMPORTANT Access to components behind the panel where the thin client or computer is installed is restricted to authorized and properly trained personnel.

- When the thin client or computer is mounted in an enclosure, keep the enclosure door closed during operation so dust and other airborne contamination do not infiltrate the thin client or computer. Open the door only for routine maintenance.



SHOCK HAZARD: Do not operate the thin client or computer with the covers removed. An electric shock hazard exists. All covers are required to maintain EMI shield.

- Always use the proper power down procedures as required by your operating system, such as the Shut Down command in the Microsoft Windows operating system (OS).
- After you shut down the thin client or computer, do not apply power again until shutdown is complete.

Touch Screen Precautions



WARNING: If the LCD screen darkens or if the backlight is not functioning properly, the screen may be difficult to read and use of this screen could result in a potentially hazardous outcome. Do not use the LCD touch screen under these circumstances.

The design of the system must take into account the possibility of the LCD screen or LCD touch screen losing functionality and unable to be used to maintain or change control of the system. The touch screen shall not be the single point of control of critical functions and is not intended to replace an E-stop.

Design of the system should follow all applicable code and good engineering practice. Factors to consider include the following:

- The possibility of an unreadable LCD screen
- The possibility of an inoperable touch screen
- Unexpected communication errors or delays
- Operator error in the control of the system
- Proper use of E-stops and other safety practices

The user shall provide means to achieve a safe state during anomalies and verify that the system has adequate redundancy for critical functions.

Failure to follow these instructions can result in death, serious injury, or equipment damage.

Touch Screen Driver Software

VersaView 5400 integrated display industrial computers are factory calibrated and do not need field calibration. They are shipped with a specialized touch screen driver (eGalaxTouch) and configuration utility that are optimized for single-touch mouse emulation applications such as FactoryTalk® View.

VersaView 5200 integrated display thin clients must be configured and calibrated via ThinManager® software. For more information on how to configure and calibrate, see <https://thinmanager.com/support/manuals/>.

IMPORTANT ThinManager software only supports single-touch operation.
The USB touch screen driver module must be added to the terminal configuration.

Reinstall the Microsoft HID Driver on VersaView 5400 Integrated Display Computers

The factory-installed eGalaxTouch screen driver on VersaView 5400 integrated display industrial computers is for single touch applications. By default, the Windows OS on these computers report that 'No Pen or Touch Input is available for this Display' for multi-touch operation.

If you want the Windows OS to recognize the native Microsoft HID multi-touch driver, then you must first uninstall the eGalaxTouch screen driver.

To uninstall the eGalaxTouch screen driver, perform the following steps.

1. On your Windows task bar, click .
2. Click Control Panel.
3. In the Control Panel menu, click Programs and Features.
4. In the Programs list, find and highlight eGalaxTouch software.
5. Right-click the highlighted program name, and select Uninstall.
6. After you uninstall eGalaxTouch software, restart your computer.

Windows automatically installs the native Microsoft HID touch screen driver, and then reports the computer as having 'Touch Input Available with 10 Touch Points.'

TIP To reinstall the eGalaxTouch screen driver, access the Rockwell Automation® Product Compatibility and Download Center (PCDC) at <https://compatibility.rockwellautomation.com/Pages/home.aspx>.
If you must reinstall the touch screen driver, the touch screen utility automatically detects the USB port used by the touch screen controller.

Start the Thin Client or Computer

Follow these steps to start your VersaView thin client or computer.

IMPORTANT The following steps apply to when the thin client or computer must be manually started. See [Connect Power on page 31](#) for when power is applied to the thin client or computer for the first time.

1. Make sure all necessary peripheral devices are connected to the corresponding I/O ports on the thin client or computer.
2. Make sure any connected components with separate power supplies (such as an external display) are turned on first.

3. Install power to the power input of the thin client or computer.

AC powered models: See [AC Power Options on page 33](#) for how to install an AC-to-DC power adapter to the DC power input on the thin client or computer.

DC powered models: See [Connect DC Power on page 31](#) for how to install DC power to the DC power input on the thin client or computer.

4. Apply power to the thin client or computer.
5. Press the power switch on the thin client or computer.

See Hardware Features on [page 11](#) or [page 14](#) for the power switch location.

The thin client or industrial computer performs certain actions when it is started or reset. See [Restart the Thin Client or Computer on page 38](#) for what is done.

If your system does not start or you notice other anomalies, refer to [Troubleshoot the System](#) starting on [page 47](#).

Restart the Thin Client or Computer

Use any of the following methods to restart the thin client or computer.

- From the Start menu, choose Restart.
- Press Ctrl+Alt+Delete on an attached keyboard and click Restart.

During a restart, the thin client or computer does the following:

- Clears the RAM.
- Starts the POST.
- Initializes peripheral devices such as drives and printers.
- Loads the operating system (except for VersaView ThinManager® thin client computers).

If a display is available, use it to view the progress of the POST, the initialization of accessory devices, and the startup dialogs for any operating system that is installed.

Shut Down the Thin Client or Computer

Use either of the following methods to shut down the thin client or computer.

Method	Actions
Windows OS	<p>IMPORTANT: Applies only to VersaView 5400 integrated display industrial computers.</p> <p>With an attached mouse and keyboard, do one of the following.</p> <ul style="list-style-type: none"> • Press Ctrl+Alt+Delete and click Shut Down. • From the Start menu, click or choose Shut Down.
Power switch	<p>Momentarily press the power switch to shut down the thin client or computer. See Hardware Features on page 11 or page 14 for the power switch location.</p>

Configure the UEFI (BIOS) Settings

Topic	Page
Set-up Utility Overview	39
Access the Set-up Utility	40
UEFI Overview	40
H/W Monitor	40
Security	40
Restore the OS Image	41
Upgrade to a New UEFI	42

Set-up Utility Overview

The set-up utility is a hardware configuration program built into the universal extensible firmware interface (UEFI). In this chapter, UEFI replaces Basic Input/Output System (BIOS) to describe the system firmware except where BIOS is specifically used, such as on a graphical interface.

You can run the set-up utility to do the following:

- Change the system configuration.
- Set the time and date as part of a commissioning step.

TIP

A commissioning step is one of the following situations:

- When the thin client or computer is powered up initially
 - When the Windows OS image is restored (on VersaView® 5400 computers)
 - When the UEFI set-up utility is upgraded
- Redefine communication ports to help prevent any conflicts.
 - Read the current amount of system memory.
 - Change the boot drive order.
 - Set or change the password or make other changes to the security settings.

Access the Set-up Utility

Follow these steps to access the set-up utility in your thin client or computer.

IMPORTANT An external keyboard must be connected to the computer to perform these steps.

1. Start or restart your computer.
2. During POST, press F2 to access the UEFI set-up utility.

UEFI Overview

The main tab is the default screen whenever you access the UEFI interface. Depending on the UEFI, there are other tabs with configurable menu items

UEFI for All Cat. Nos. Except 6200T-KB, 6200T-RC, and 6200T-RE

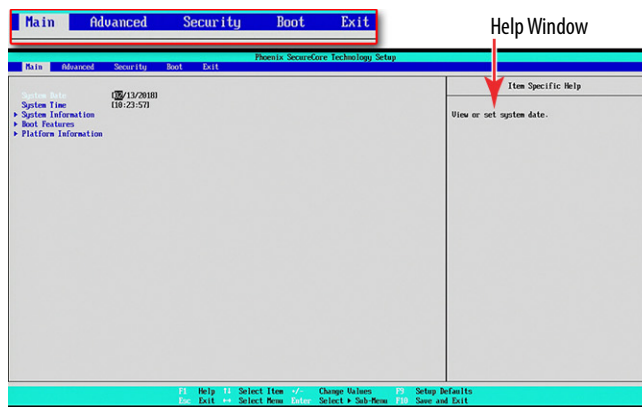

UEFI for Cat. Nos. 6200T-KB, 6200T-RC, and 6200T-RE

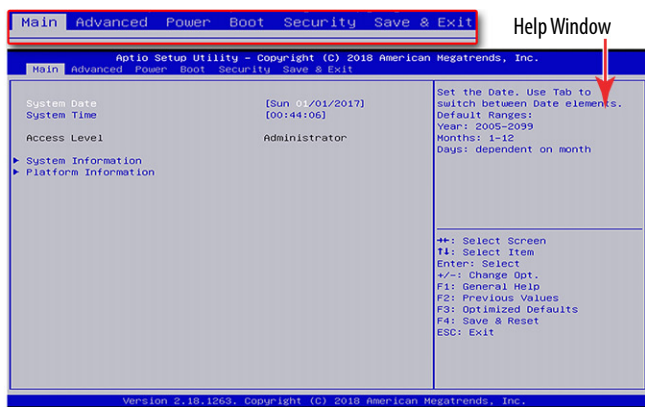

Help Window

When you select a menu or submenu item, a corresponding help menu displays to the right of the item. As you toggle between menu items, the help menu updates automatically.

H/W Monitor

You can view various hardware parameters from the H/W Monitor menu. It shows the temperature and system voltage measurements. This menu is beneficial to identify possible computer issues.

Security

The Security tab of the UEFI set-up utility provides password protection for applications where security is preferred or needed.

You can set a supervisor password that is required to access the UEFI set-up utility. You can set a user password that is required for computer startup.

Restore the OS Image

Perform the following steps to restore your computer with a backed-up OS image on an external USB storage drive.

1. Attach the following external peripherals to your computer:
 - Display (for non-display computers)
 - USB Keyboard
 - USB drive (16 GB or larger)
2. Access the Rockwell Automation® PCDC website at <https://compatibility.rockwellautomation.com/Pages/home.aspx>.
3. On the home page, click Find Downloads.
4. On the Find Downloads page, use your computer model as the search criteria.
5. Follow the instructions on the PCDC site to find your OS image.

TIP You must be registered with the Rockwell Automation PCDC website to download files.

You must accept a User Agreement before files can be downloaded.

6. Download the OS Image file to your USB drive.
7. After the file downloads, restart the computer.
8. During POST, press F5 to access the Boot menu.
9. Toggle down the Boot menu to select RecoveryDISK and press Enter.

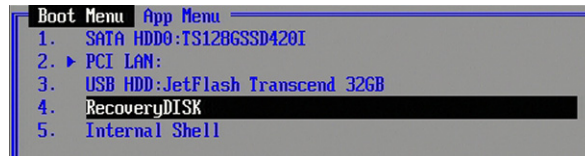

10. To apply the image, follow the onscreen instructions.
11. The OS image file on the USB drive copies to the system.



WARNING: Do not interrupt power to the computer during the OS image restore.

Sudden power loss can render the computer inoperable.

12. After the OS image restore is complete, restart the computer.
13. When you restore the OS image, it is identical to starting the computer for the first time.

See [Connect Power on page 31](#) for what actions occur.

Upgrade to a New UEFI

Sometimes a new UEFI (BIOS) is released to enhance the performance of your computer or to correct an anomaly. In such cases, you can download BIOS upgrades at the Rockwell Automation PCDC website at <https://compatibility.rockwellautomation.com/Pages/home.aspx>. A USB drive upgrade is available.

For All VersaView 5000 ThinManager® Thin Client and Industrial Computers Except Cat. No. 6200T-BA

For instructions to upgrade the BIOS for Cat. No. 6200T-BA, see [page 44](#).

To upgrade the BIOS for other VersaView 5000 ThinManager thin client and industrial computers, perform the following steps.

1. Attach the following external peripherals to your computer:
 - Display (for non-display computers)
 - USB keyboard
 - USB drive (1 GB or larger)
2. Access the Rockwell Automation PCDC website.
3. On the home page, click Find Downloads.
4. On the Find Downloads page, use your computer model as the search criteria.
5. Follow the instructions on the PCDC site to find your BIOS.

TIP You must be registered with the Rockwell Automation PCDC website to download files.

You must accept a User Agreement before files can be downloaded.

6. Download the BIOS file to your USB drive.
7. Open the file and extract the folder to the root directory of your USB drive.
8. After the folder is extracted, restart the computer.
9. During POST, press F5 to access the Boot menu.

- Toggle down the Boot menu to select Internal Shell and press Enter.

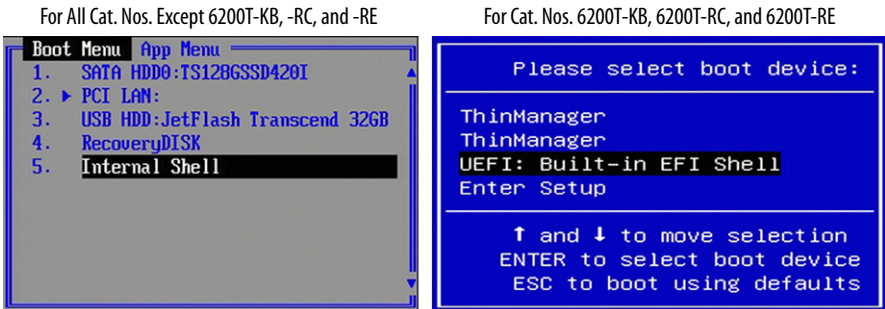

The internal shell displays.

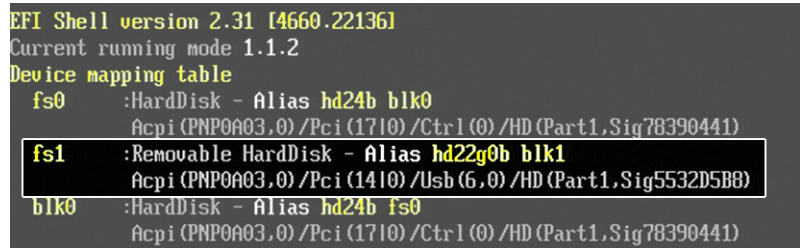

IMPORTANT Depending on what other drives are attached to your system, the attached USB drive can be mapped as the fs1 or fs2 drive, and as a removable hard disk.

- Type **fsX:** (where 'X' is the number shown for your mapped USB drive) and press Enter (A).



- To navigate to the folder where the BIOS is stored, use a DOS-type command to identify the folder (for example, **cd <folder_name>**) and press Enter (B).
- Type **update.nsh** and press Enter (C).

The BIOS update procedure starts automatically.

IMPORTANT Ignore any 'PDR Region does not exist' messages.



WARNING: Do not disconnect power from the computer until after the BIOS flash procedure is completed. If power is disconnected during this procedure, it can render the computer inoperable.

- Once the BIOS flash procedure is completed, restart the computer.

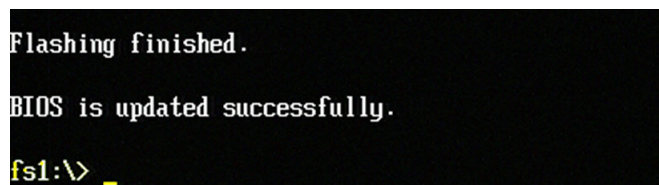

For VersaView 5200 ThinManager Thin Client Cat. No. 6200T-BA

To upgrade the BIOS for VersaView 5200 ThinManager thin client Cat. No. 6200T-BA, perform the following steps.

1. Attach the following external peripherals to your computer:
 - Display
 - USB keyboard
 - USB drive (1 GB or larger)
2. Access the Rockwell Automation PCDC website:
<https://compatibility.rockwellautomation.com/Pages/home.aspx>
3. On the home page, click Find Downloads.
4. On the Find Downloads page, use your computer model (6200T-BA) as the search criteria.
5. Follow the instructions on the PCDC site to find your BIOS.

TIP You must be registered with the Rockwell Automation PCDC website to download files.

You must accept a User Agreement before files can be downloaded.

6. Download the BIOS file to your USB drive.
7. Open the file and extract the folder to the root directory of your USB drive.
8. After the folder is extracted, restart the computer.
9. During POST, press F11 to access the internal shell.

The internal shell displays.

```
EFI Shell version 2.31 [4660.22136]
Current running mode 1.1.2
Device mapping table
fs0 :Removable HardDisk - Alias hd21b0b blk0 A
      Acpi (PNP0A03,0)/Pci (1410)/Usb (1,0)/HD (Part1,SigD9417B89)
blk0 :Removable HardDisk - Alias hd21b0b fs0
      Acpi (PNP0A03,0)/Pci (1410)/Usb (1,0)/HD (Part1,SigD9417B89)
blk1 :Removable HardDisk - Alias (null)
      Acpi (PNP0A03,0)/Pci (1410)/Usb (1,0)/HD (Part2,SigD9417B89)
blk2 :Removable BlockDevice - Alias (null)
      Acpi (PNP0A03,0)/Pci (1410)/Usb (1,0)

Press F5C in 1 seconds to skip startup.nsh, any other key to continue.
Shell> fs0: B
fs0:\> cd TCB100 C
fs0:\TCB100> Update.nsh_ D
```

IMPORTANT Depending on what other drives are attached to your system, the attached USB drive can be mapped as the fs1 or fs2 drive, and as a removable hard disk (A).

10. Type **fsX:** (where 'X' is the number shown for your mapped USB drive) and press Enter (B).
11. To navigate to the folder where the BIOS is stored, use a DOS-type command to identify the folder (for example, **cd <folder_name>**) and press Enter (C).

12. Type **update.nsh** and press Enter (D).

The BIOS update procedure starts automatically.

IMPORTANT Ignore any 'Cannot find any ESP partition!' messages during the update.



WARNING: The computer automatically restarts twice during the update. Do not disconnect power from the computer until after the second restart, which is when the BIOS flash procedure is completed. If power is disconnected before the second restart, it can render the computer inoperable.

13. Once the BIOS flash procedure is completed, the computer automatically restarts.

```
Image flashing done.  
Flashing finished.  
BIOS is updated successfully.  
WARNING: System will shutdown or reboot in 5 seconds!
```

Notes:

Troubleshoot the System

Topic	Page
Hardware (H/W) Monitoring	47
Troubleshooting	48
Load the System Defaults	48
Ship or Transport the Computer	49
Dispose of the Computer	49

Hardware (H/W) Monitoring

The built-in hardware monitor of the computer tracks the operating threshold levels of the voltage and temperature sensors.

Follow these steps to determine whether an operating threshold has been reached.

1. Shut down the computer by using the appropriate method for the installed operating system.

See [Shut Down the Thin Client or Computer on page 38](#) for more information.

2. Apply power to the computer.
3. During POST, press F2 to access the UEFI set-up utility:
4. On the Main screen, click Advanced.
5. On the Advanced screen, click H/W Monitor.

Use this menu to determine if there is an issue with internal voltages or component temperatures.

Troubleshooting

Follow these steps to identify and isolate an issue with the computer's operation.

1. Shut down the computer by using the appropriate method for the installed operating system.
See [Shut Down the Thin Client or Computer on page 38](#) for more information.
2. Disconnect power to the computer.
3. Disconnect all peripheral devices from the computer.
4. If a keyboard and mouse are used, verify that they are properly connected.
5. If an external display is used, verify that it is properly connected.
6. Connect power to the computer. During POST, one of three events occurs:
 - The startup process is completed.
 - A nonfatal error occurs and the related error message is displayed.
 - A fatal error occurs and the startup process terminates.

If	Then
The computer starts	Reconnect all peripheral devices one at a time until the issue occurs.
The issue is with a specific software or driver	Reinstall the software or driver.

Load the System Defaults

If the computer fails after you make changes in the set-up menus, load the system default settings to correct the error. These default settings have been selected to optimize computer performance.

Follow these steps to load the system defaults.

IMPORTANT An external keyboard and mouse must be connected to the computer to perform these steps.

1. Restart the computer as specified in [Restart the Thin Client or Computer on page 38](#).
2. During POST, press F2 to access the UEFI set-up utility.
3. On the main UEFI screen, click the Exit tab.
4. On the Exit screen, press the ↓ arrow key to access Load Setup Defaults.
5. Press Enter to select Load Setup Defaults.
6. Press F10 to save and exit.

The change resets the system automatically.

Ship or Transport the Computer

If you must ship the computer via common carrier or otherwise transport it to another location for service or any other reason, you must first uninstall the computer and place it in its original packing material.



ATTENTION: Do not ship or transport the computer when it is installed in a machine, panel, or rack. To avoid damage to the computer, you must uninstall the computer and place it in its original packing material before you ship it. Rockwell Automation is not responsible for damage to a computer that is shipped or transported while installed in a machine, panel, or rack.

Dispose of the Computer



At the end of its life, collect the computer separately from any unsorted municipal waste.

You cannot dispose of computer equipment like other waste material. Most computers and monitors contain heavy metals that can contaminate the earth. Therefore, check with local health and sanitation agencies for ways to safely dispose of computer equipment.

When a storage drive is part of what you plan to dispose, then permanently erase any data on it or destroy the drive before it is disposed.

Notes:

Clean the Thin Client or Computer

Topic	Page
Clean the Thin Client or Computer	51

Clean the Thin Client or Computer

To maintain your computer, it is important to clean the display, cooling fins, and vent holes, and to remove grease or paint.

IMPORTANT VersaView® 5000 ThinManager® thin clients and industrial computers resist the following chemicals:

- Alcohol (methyl, ethyl, or isopropyl)
 - Ammonia (10% dilute solution)
 - Automatic transmission fluid
 - Bleach
 - Commercial glass cleaners
 - Diesel fuel
 - Gasoline (unleaded)
 - Oil (hydraulic or motor)
 - Silicone-based lubricant
-

Clean the Integrated Display

Perform the following steps to clean a display (applies to VersaView 5000 ThinManager thin clients and industrial computers with an integrated display).

1. Disconnect power from the computer at the power source.



ATTENTION: Since the display is a touch screen, it is possible for screen objects to activate during equipment wash-downs if the computer is turned on.

2. Clean the display with a mild soap and a clean sponge or a soft cloth.



ATTENTION: Use of abrasive cleansers, solvents, and high-pressure washes can damage the display window. Do not scrub or use brushes.

3. Dry the display with a chamois or moist cellulose sponge to avoid water spots.

Clean the Air Openings and Cooling Fins

Perform the following steps to clean all VersaView 5000 ThinManager thin clients and industrial computers.

1. Disconnect power from the computer at the power source.
2. Disconnect all peripheral devices from the computer.
3. Vacuum dust and debris from the vent holes on the sides of the integrated display computers, and from the cooling fins on the chassis of all computers.

Remove stubborn dirt on the cooling fins with a mild detergent and soft cloth.

Remove Paint and Grease from Bezel

Perform the following steps to remove paint and grease from the bezel of computers properly mounted in IP65 enclosures.

1. Remove paint splashes and grease by rubbing lightly with isopropyl alcohol.



ATTENTION: Make sure the isopropyl alcohol does not come in contact with the equipment labels. Alcohol can cause the label printing to smear.

2. Use a mild soap or detergent solution to remove residue.
3. Rinse with clean water.

Install Accessories

Topic	Page
Available Accessories	53
Disconnect Power	53
Electrostatic Discharge Precautions	54
Pre-configuration	54
Post-configuration	55
Required Tools	55
Replace a Factory-installed Bookshelf Mounting Plate (Cat. No. 6200V-BXWALL)	55
Install the VESA Mounting Plate (Cat. No. 6200V-BXVESA)	56
Install the DIN Rail Mounting Kit (Cat. No. 6200V-BXDIN)	59
Install the Machine Mounting Bracket Kit (Cat. No. 6200V-BXMACH)	62
Install the Legacy Mounting Plate (Cat. No. 6200V-BXLGCY)	66

Available Accessories

You can view a list of accessories at <https://ab.rockwellautomation.com/Computers/Integrated-Display-Computers/6200-VersaView-5400>.

Review the specifications of a new component before you install it to verify that it is compatible with the computer. Record the model, serial number, and any other pertinent information of new components for future reference.

IMPORTANT We recommend that you use only Allen-Bradley® approved accessories.

Disconnect Power

There is line voltage input to any power supply adapters. Disconnect all power to the computer before you install or remove components.



SHOCK HAZARD: Do not disconnect equipment unless power has been switched off and the area is known to be non-hazardous.

Failure to disconnect power can result in severe electrical shock to an individual or damage to the computer.

Electrostatic Discharge Precautions



ATTENTION: Electrostatic discharge (ESD) can damage static-sensitive devices or microcircuitry:

- Disconnect all power before you work on the computer as detailed in [Disconnect Power on page 53](#).
- Observe proper packaging and grounding techniques to help prevent damage.

Follow these ESD precautions:

- Transport the computer and replacement parts in static-safe containers, such as conductive tubes, bags, or boxes.
- Keep electrostatic-sensitive parts in their containers until they arrive at the designated static-free work area.
- Cover the designated work area with approved static-dissipating material:
 - Use an anti-static wriststrap connected to the work surface.
 - Use properly grounded tools and equipment.
- Keep the designated work area free of nonconductive materials, such as ordinary plastic assembly aids and foam packing.
- Avoid touching pins, leads, or circuitry.
- Always hold components with a printed circuit board (PCB) by its edges and place it with the assembly side down.

Pre-configuration



ATTENTION: Make sure to read and understand all installation and removal procedures before you configure the computer hardware.

Follow these steps before you remove or install a hardware component.

1. Shut down the computer and all peripherals that are connected to it.
2. Disconnect all cables from power outlets to avoid exposure to high energy levels.
If necessary, label each cable to expedite reassembly.
3. Disconnect all peripheral cables from the bottom I/O ports.
4. If the computer is table or wall mounted, loosen the mounting screws.
Remove the computer from its mounting.

Post-configuration

Follow these steps after you install or replace a hardware component.

1. If the computer was wall or table mounted, reinstall the computer to its mounting.
Tighten the mounting screws.
2. Reinstall any peripherals and system cables that were previously removed.
3. Reconnect all external cables and power to the computer.
4. Press the power switch to start the computer.

Required Tools

The following tools are required to install or replace a component:

- The appropriate tools for wall or machine mounting
- Torx 10 key or screwdriver

Replace a Factory-installed Bookshelf Mounting Plate (Cat. No. 6200V-BXWALL)

To replace the factory-installed bookshelf mounting plate to a non-display thin client or industrial computer with a new mounting plate, perform the following steps.

IMPORTANT See [Table 4 on page 29](#) for what VersaView 5000 devices can use this accessory. To replace the factory-installed bookshelf mounting plate on VersaView® 5200 ThinManager® thin client computer with single display output (Cat. No. 6200T-BA), see the instructions on [page 56](#).

1. Follow the steps for [Pre-configuration on page 54](#).
2. With the Torx 10 key or screwdriver, remove the two screws shown below on the bottom of the non-display thin client or computer.



3. Remove the four screws that secure the factory-installed mounting plate to the back of the non-display thin client or computer.



4. Remove the factory-installed mounting plate.
5. Install the new mounting plate (Cat. No. 6200V-BXWALL) with the four screws that you removed in [step 3](#).
6. Reinstall the two screws that you removed in [step 2](#) on [page 55](#).
7. Follow the steps for [Post-configuration on page 55](#).

Bookshelf Mounting Plate (Cat. No. 6200V-BXWALL2) For VersaView 5200 ThinManager Thin Client Non-display Computer (Cat. No. 6200T-BA)

1. Follow the steps for [Pre-configuration on page 54](#).
2. With the Torx 10 key or screwdriver, remove the four screws that secure the factory-installed mounting plate to the back of the thin client.



3. Install the new mounting plate (Cat. No. 6200V-BXWALL2) with the four screws that you removed in [step 2](#).
4. Follow the steps for [Post-configuration on page 55](#).

Install the VESA Mounting Plate (Cat. No. 6200V-BXVESA)

IMPORTANT If you choose to VESA mount an integrated display thin client or industrial computer, its IP rating is reduced from IP65 to IP20.

Observe these guidelines when you install an integrated display VersaView thin client or industrial computer on a mounting arm:

- The mounting surface and the mounting arm must be strong enough to support the thin client or computer and the mounting hardware.
- The interface between the mounting arm and the computer must meet VESA FPM PMI 100 mm (3.94 in.) standards.
- The mounting location must provide adequate clearance to position and move the adjustable unit, and to route cables.

To install a VESA mounting plate to a non-display VersaView thin client or industrial computer, perform the following steps.

IMPORTANT See [Table 4 on page 29](#) for what VersaView 5000 devices can use this accessory. To install a VESA mounting kit on the VersaView 5200 ThinManager thin client single display model (Cat. No. 6200T-BA), see the instructions on [page 58](#).

1. Follow the steps for [Pre-configuration on page 54](#).

2. With a Torx 10 key or screwdriver, remove the two screws shown below on the bottom of the non-display thin client or computer.



3. Remove the four screws that secure the factory-installed mounting plate to the back of the non-display thin client or computer.

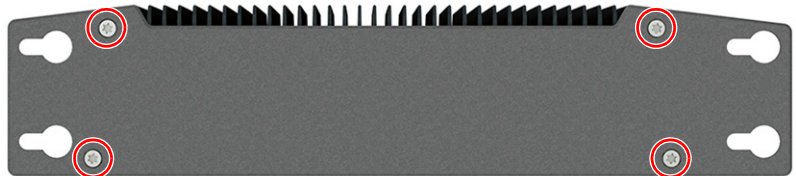

4. Remove the factory-installed mounting plate.
5. Install the new backplate supplied with the VESA mounting bracket kit with the four screws that you removed in [step 3](#).

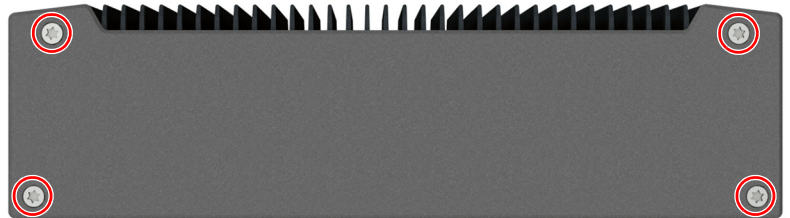

6. Reinstall the two screws that you removed in [step 2](#).
7. With the four supplied screws, install the VESA mounting bracket (Cat. No. 6200V-BXVESA) to the VESA mounting arm.

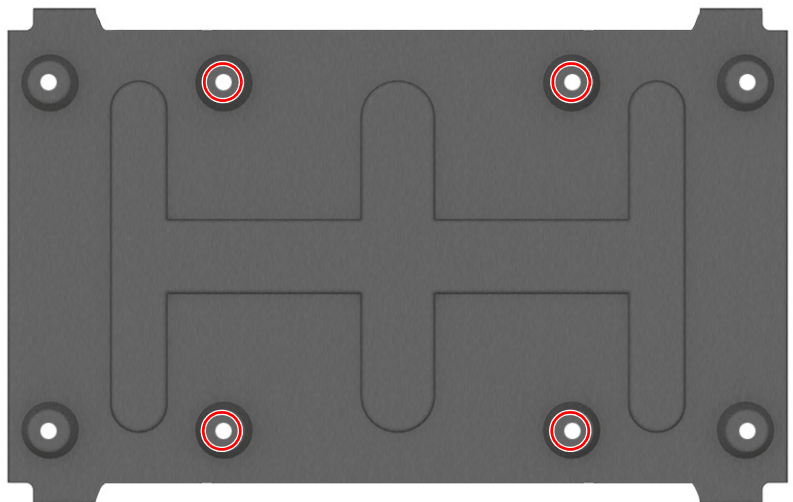

8. Remove the two screws (A) from the top of the non-display thin client or computer.
9. Remove two screws (B) from the bottom of the non-display thin client or computer.

TIP Cat. No. 6200T-NA model used for illustrative purposes in [steps 8](#) and [9](#).

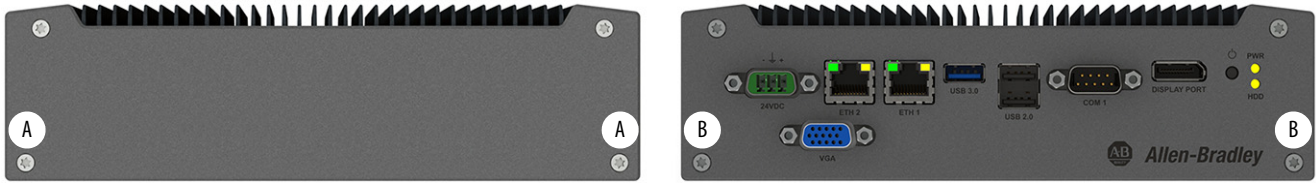

10. Install the non-display thin client or computer to the VESA mounting bracket, replacing the four screws that you removed in steps 7 and 8.

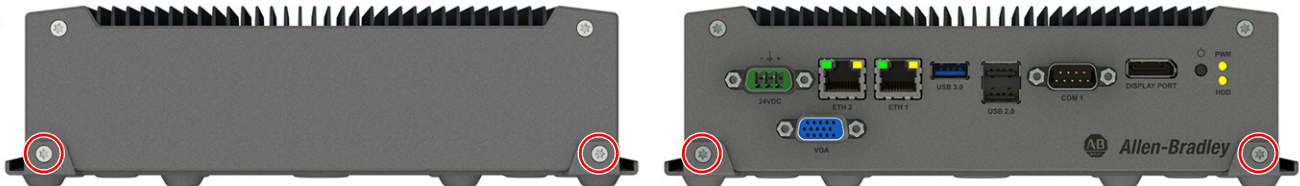

11. Follow the steps for [Post-configuration on page 55](#).

VESA Mounting Plate (Cat. No. 6200V-BXVESA2) For VersaView 5200 ThinManager Thin Client Single Display Model (Cat. No. 6200T-BA)

1. Follow the steps for [Pre-configuration on page 54](#).
2. With a Torx 10 key or screwdriver, remove the four screws that secure the factory-installed mounting plate to the back of the thin client.



3. Install the new backplate from the VESA mounting kit (6200V-BXVESA2) with the four screws that you removed in [step 2](#).



- With the four supplied screws, install the VESA mounting bracket (Cat. No. 6200V-BXVESA2) to the VESA mounting arm.

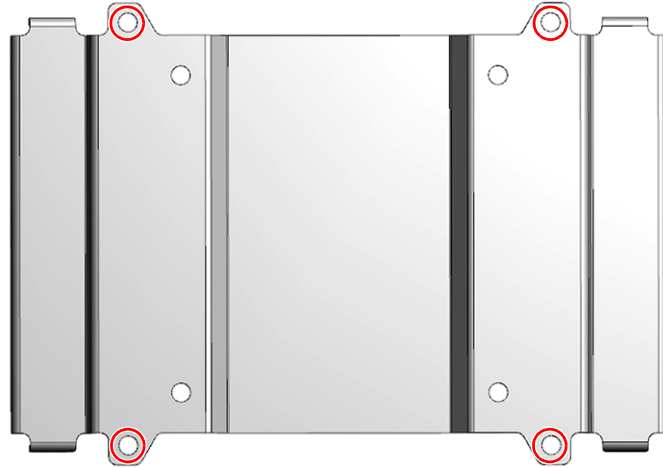

- Remove the two screws (A) from the top of the thin client.
- Remove the two screws (B) from the bottom of the thin client.

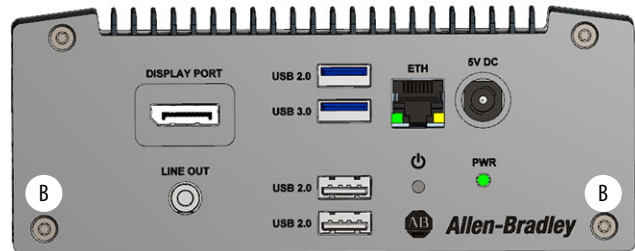

- Install the thin client to the VESA mounting bracket with the four screws that you removed in steps 5 and 6.

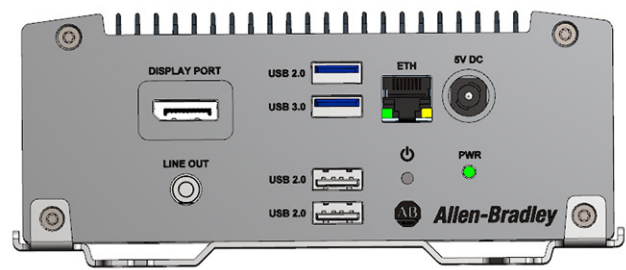
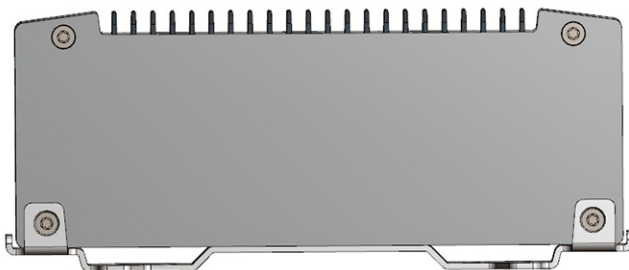

- Follow the steps for [Post-configuration on page 55](#).

Install the DIN Rail Mounting Kit (Cat. No. 6200V-BXDIN)

To install a DIN rail mounting kit on a non-display VersaView ThinManager thin client or industrial computer), perform the following steps.

IMPORTANT See [Table 4 on page 29](#) for what VersaView 5000 devices can use this accessory. To install a DIN rail mounting kit on the VersaView 5200 ThinManager thin client single display model (Cat. No. 6200T-BA), see the instructions on [page 61](#).

- Follow the steps for [Pre-configuration on page 54](#).

2. With a Torx 10 key or screwdriver, remove the two screws shown below on the bottom of the non-display thin client or computer.



3. Remove the four screws that secure the factory-installed mounting plate to the back of the non-display thin client or computer.



4. Remove the factory-installed mounting plate.
5. Install the new backplate from the DIN rail mounting kit (Cat. No. 6200V-BXDIN) with the four screws that you removed in [step 3](#).

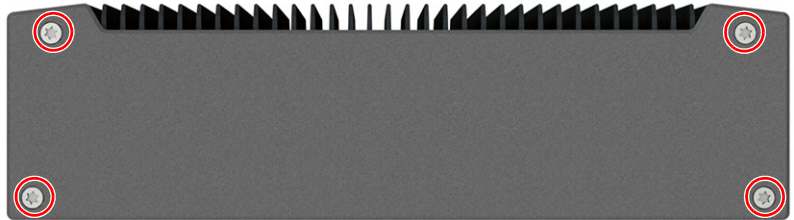

6. Reinstall the two screws that you removed in [step 2](#).
7. Remove the two Torx screws shown below on the back of the thin client or computer.



8. Install the DIN rail mounting bracket from the kit with the two removed screws.



9. Install the computer on a DIN rail.
10. Follow the steps for [Post-configuration on page 55](#).

DIN Rail Mounting Kit (Cat. No. 6200V-BXDIN2) For VersaView 5200 ThinManager Thin Client Single Display Model (Cat. No. 6200T-BA)

1. Follow the steps for [Pre-configuration on page 54](#).
2. With a Torx 10 key or screwdriver, remove the four screws that secure the factory-installed mounting plate to the back of the thin client.



3. Install the new backplate from the DIN rail mounting kit (Cat. No. 6200V-BXDIN2) with the four screws that you removed in [step 2](#).



4. Decide how you want to mount the DIN rail bracket from the kit on the thin client.



For Horizontal Orientation



For Vertical Orientation

5. Install the DIN rail mounting bracket with the two supplied Torx screws.
6. Install the thin client on a DIN rail.
7. Follow the steps for [Post-configuration on page 55](#).

Install the Machine Mounting Bracket Kit (Cat. No. 6200V-BXMACH)

There are two available machine mounting bracket kits.

IMPORTANT The two available machine mounting bracket kits cannot be installed on the VersaView 5200 ThinManager thin client single display model (Cat. No. 6200T-BA).

- Cat. No. 6200V-BXMACH2 can be used on non-display VersaView ThinManager thin client multi-4K display models (Cat. Nos. 6200T-RC and 6200T-RE). Installation instructions start on [page 65](#).
- Cat. No. 6200V-BXMACH can be used on several non-display VersaView ThinManager thin client and industrial computers; for those devices, see [Table 4 on page 29](#).

To install the machine mounting bracket kit (Cat. No. 6200V-BXMACH), perform the following steps.

1. Follow the steps for [Pre-configuration on page 54](#).
2. With a Torx 10 key or screwdriver, remove the two screws shown below on the bottom of the non-display thin client or industrial computer.



3. Remove the four screws that secure the factory-installed mounting plate to the back of the non-display thin client or industrial computer.

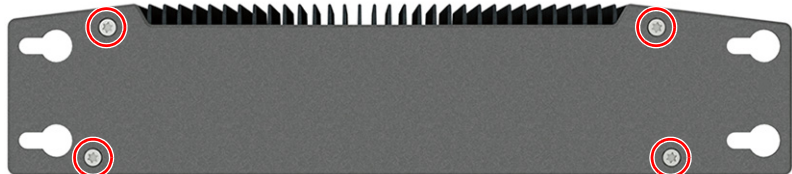

4. Remove the factory-installed mounting plate.
5. Install the new backplate from the machine mounting bracket kit with the four screws that you removed in [step 3](#).

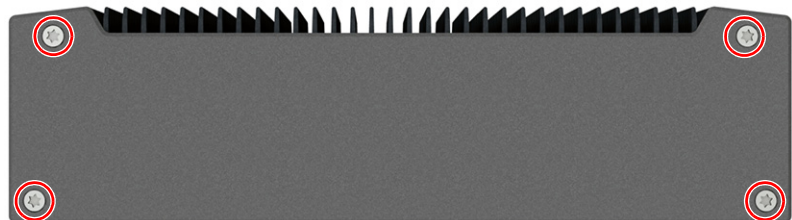

6. Remove the six Torx screws shown below.

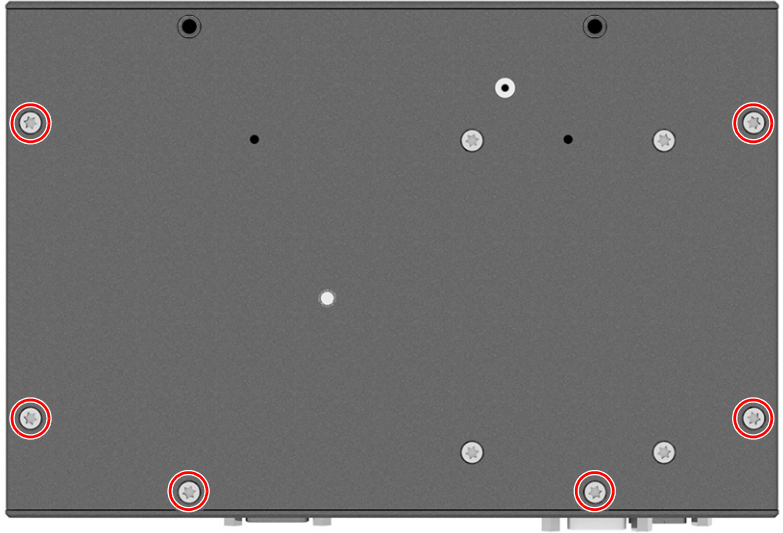

7. Install both brackets included in the kit with the eight removed screws.

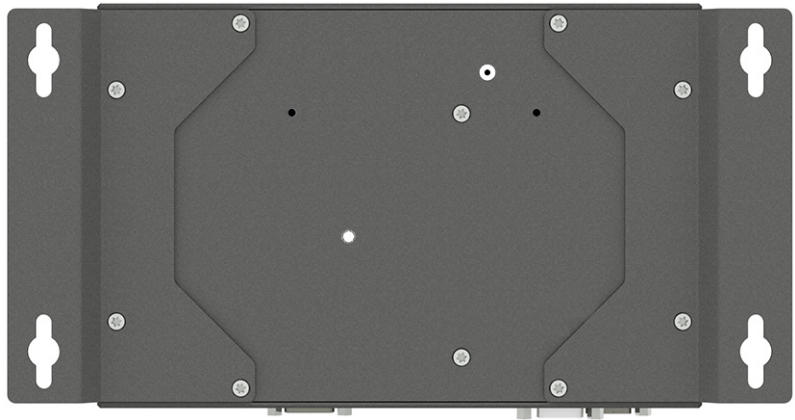

8. Mount the machine mounting bracket with the appropriate tools and mounting hardware for the surface material.

The following dimensions are given in mm (in.).

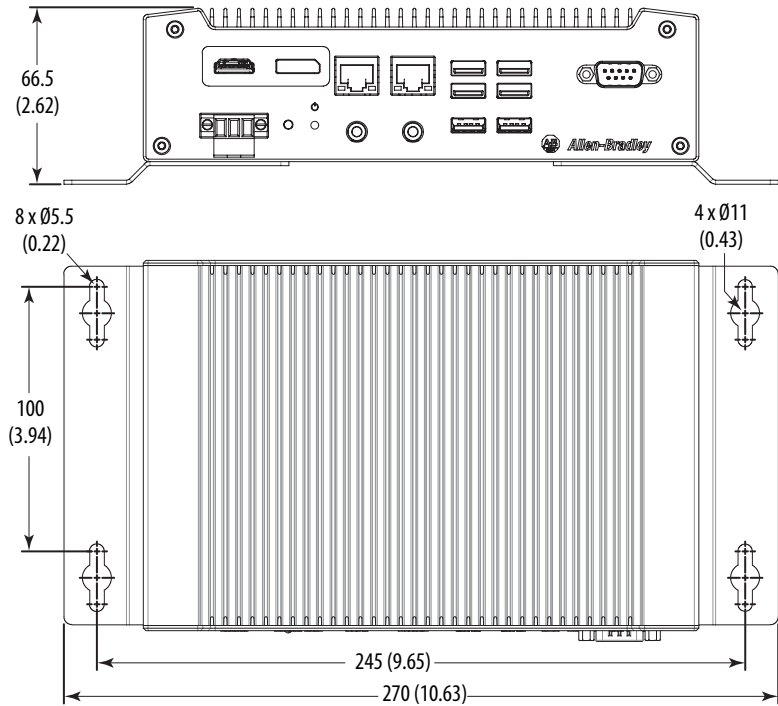

IMPORTANT For acceptable machine mounting positions, see [Figure 11 on page 28](#).

9. Follow the steps for [Post-configuration on page 55](#).

Machine Mounting Bracket Kit (Cat. No. 6200V-BXMACH2) For Non-display VersaView 5200 ThinManager Thin Client Multi-4K Display Models (Cat. Nos. 6200T-RC and 6200T-RE)

To install the machine mounting bracket kit (Cat. No. 6200V-BXMACH2), perform the following steps.

1. Follow the steps for [Pre-configuration on page 54](#).
2. With a Torx 10 key or screwdriver, remove the eight screws shown below on the bottom of the non-display thin client.



3. Install both brackets included in the kit with the eight removed screws.



4. Mount the machine mounting bracket with the appropriate tools and mounting hardware for the surface material.

The following dimensions are given in mm (in.).

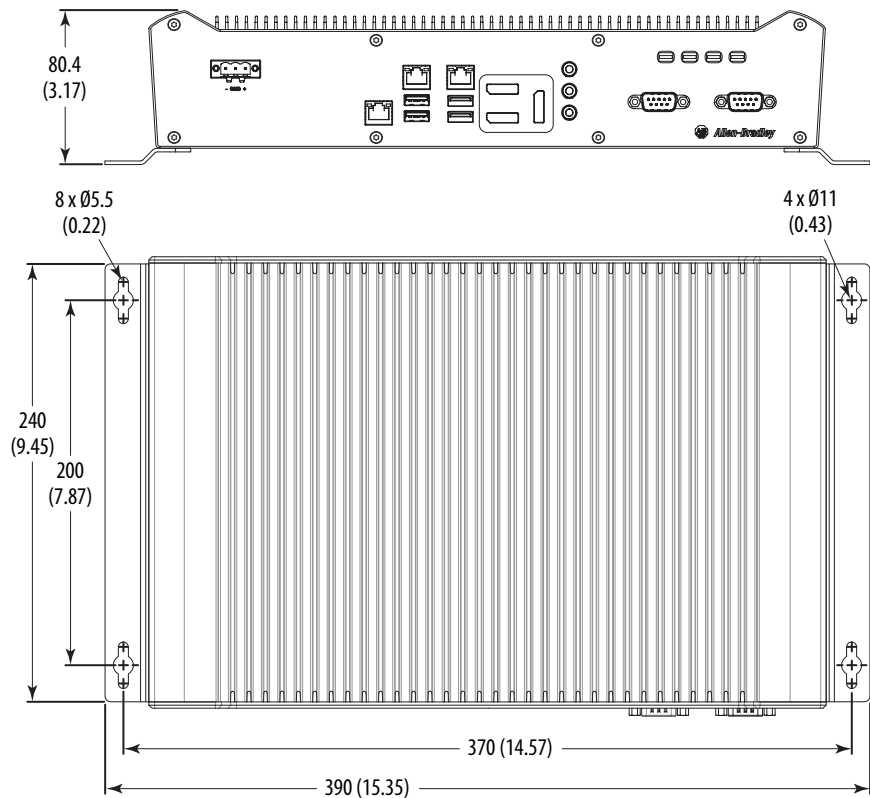

IMPORTANT For acceptable machine mounting positions, see [Figure 11 on page 28](#).

5. Follow the steps for [Post-configuration on page 55](#).

Install the Legacy Mounting Plate (Cat. No. 6200V-BXLGCY)

Install a legacy mounting plate when a non-display VersaView ThinManager thin client or industrial computer replaces an Allen-Bradley® 6155R compact non-display computer.

There are several non-display VersaView ThinManager thin client and industrial computers that can use this mounting plate; for those devices, see [Table 4 on page 29](#).

IMPORTANT The legacy mounting plate cannot be installed on the VersaView 5200 ThinManager thin client single display model (Cat. No. 6200T-BA).

The legacy mounting plate reuses the mounting holes for the 6155R compact non-display computer, and reuses the mounting hardware.

To install a legacy mounting plate (Cat. No. 6200V-BXLGCY) on a non-display VersaView thin client or industrial computer, perform the following steps.

1. If not already done, remove the 6155R compact non-display computer by following the steps for [Pre-configuration on page 54](#).
2. With a Torx 10 key or screwdriver, remove the two screws shown below on the bottom of the non-display thin client or industrial computer.



3. Remove the four screws that secure the factory-installed mounting plate to the back of the non-display thin client or industrial computer.



4. Remove the factory-installed mounting plate.
5. Install the legacy mounting plate with the four screws that you removed in [step 3](#).



6. Remove the four grommets from the mounting plate on the 6155R compact non-display computer.

7. Install the four grommets on the legacy mounting plate as shown below.



8. Align the holes on the legacy mounting plate of the non-display thin client or industrial computer with the holes used to mount the 6155R compact non-display computer.
9. Use the existing hardware to install the non-display thin client or industrial computer.
10. Follow the steps for [Post-configuration on page 55](#).

A**accessories** 53**B****BIOS Setup utility** 39

access 40

Setup screen 40

C**cleaning the computer**

chassis 52

display 52

paint/grease marks 52

configuration tools

installation 25

D**display**

cleaning precautions 52

display, cleaning 51**H****hardware diagnostics** 47**hardware features**

non-display 11, 14, 16

hardware monitor 47**I****I/O connections** 29**installation**

connect peripherals 29

environment and enclosure notice 18

guidelines 21

product dimensions 23

required tools 25

M**maintenance**

clean the computer 51

cleaning display 51

mounting

panel mounting 26, 28

N**network connection**

LAN cable reminder 18

P**panel mounting**

guidelines 25

panel cutout 26

peripherals

connect 29

POST, see Power On Self Test**power connection**

notices 31

Power On Self Test 38**R****replace components**

post-configuration procedure 55

pre-configuration procedure 54

replacement parts 53**S****Setup menu**

Firmware Update 40

system

defaults 48

system views

non-display, bottom 11, 14, 15, 16

non-display, rear 11, 14, 16

non-display, sides 11, 14, 16

T**touchscreen**

driver software 37

troubleshooting

hardware monitor 47

load system defaults 48

procedure 40, 48

Notes:

Rockwell Automation Support

Use the following resources to access support information.

Technical Support Center	Knowledgebase Articles, How-to Videos, FAQs, Chat, User Forums, and Product Notification Updates.	https://rockwellautomation.custhelp.com/
Local Technical Support Phone Numbers	Locate the phone number for your country.	http://www.rockwellautomation.com/global/support/get-support-now.page
Direct Dial Codes	Find the Direct Dial Code for your product. Use the code to route your call directly to a technical support engineer.	http://www.rockwellautomation.com/global/support/direct-dial.page
Literature Library	Installation Instructions, Manuals, Brochures, and Technical Data.	http://www.rockwellautomation.com/global/literature-library/overview.page
Product Compatibility and Download Center (PCDC)	Get help determining how products interact, check features and capabilities, and find associated firmware.	http://www.rockwellautomation.com/global/support/pcdc.page

Documentation Feedback

Your comments will help us serve your documentation needs better. If you have any suggestions on how to improve this document, complete the How Are We Doing? form at http://literature.rockwellautomation.com/idc/groups/literature/documents/du/ra-du002_-en-e.pdf.

Rockwell Automation maintains current product environmental information on its website at <http://www.rockwellautomation.com/rockwellautomation/about-us/sustainability-ethics/product-environmental-compliance.page>.

Allen-Bradley, FactoryTalk, Rockwell Automation, Rockwell Software, and VersaView are trademarks of Rockwell Automation, Inc.

Trademarks not belonging to Rockwell Automation are property of their respective companies.

Rockwell Otomasyon Ticaret A.Ş., Kar Plaza İş Merkezi E Blok Kat:6 34752 İçerenköy, İstanbul, Tel: +90 (216) 5698400

www.rockwellautomation.com

Power, Control and Information Solutions Headquarters

Americas: Rockwell Automation, 1201 South Second Street, Milwaukee, WI 53204-2496 USA, Tel: (1) 414.382.2000, Fax: (1) 414.382.4444

Europe/Middle East/Africa: Rockwell Automation NV, Pegasus Park, De Kleetlaan 12a, 1831 Diegem, Belgium, Tel: (32) 2 663 0600, Fax: (32) 2 663 0640

Asia Pacific: Rockwell Automation, Level 14, Core F, Cyberport 3, 100 Cyberport Road, Hong Kong, Tel: (852) 2887 4788, Fax: (852) 2508 1846

Publication 6200-UM001D-EN-P - April 2020

Supersedes Publication 6200-UM001C-EN-P - July 2018

Copyright © 2020 Rockwell Automation, Inc. All rights reserved. Printed in the U.S.A.