

Home Generator Systems

# Installation Instructions

## Series 8000



# Generator



**Thank you** for purchasing this quality-built Briggs & Stratton® home generator. We are pleased that you've placed your confidence in the Briggs & Stratton brand. When operated and maintained according to the instructions in the operator's manual, your home generator will provide many years of dependable service.

**This manual contains** safety information to make you aware of the hazards and risks associated with residential generator systems and how to avoid them. This generator system is designed and intended only for use as an optional home standby system that provides an alternate source of electric power and to serve loads such as heating, refrigeration systems, and communication systems that, when stopped during any power outage, could cause discomfort or inconvenience. **Save these original instructions for future reference.**

**This generator system requires professional installation before use.** The installer should follow the instructions completely.

## Where to Find Us

You never have to look far to find support and service for your generator. Consult your Yellow Pages. There are many Briggs & Stratton authorized service dealers worldwide who provide quality service. You can also contact Briggs & Stratton Customer Service by phone at **800 732-2989** between 8:00 AM and 5:00 PM CT., or click on Find a Dealer at BRIGGSandSTRATTON.COM, which provides a list of authorized dealers.

**These original instructions contain** safety information to make you aware of the hazards and risks associated with residential generator systems and how to avoid them. This product is intended for use as an optional system which provides an alternate source of electric power and to serve loads such as heating, refrigeration systems, and communication systems that, when stopped during any power outage, could cause discomfort or inconvenience.

**IMPORTANT - READ INSTRUCTIONS IN FULL BEFORE INSTALLATION.**

**IMPORTANT - SAVE THIS MANUAL FOR FUTURE REFERENCE.**

**IMPORTANT - THIS GENERATOR MUST BE INSTALLED BY A SKILLED PERSON.** The installer should follow these instructions completely.

Fill out the information below and give to user.

## For Future Reference

Please fill out the information below and keep with your receipt to assist in unit identification for future purchase issues.

**Date of Purchase**

## Generator

**Model Number**

**Model Revision**

**Serial Number**

## Engine

**Model Number**

**Serial Number**

This generator is declared compliant to IP23W requirements per IEC 60529

# Table of Contents

---

<b>SAFETY INSTRUCTIONS .....</b>	<b>4</b>
Safety Signs.....	4
Safety Alerts.....	4
<b>SAFETY RULES AND INFORMATION .....</b>	<b>8</b>
Safety Rules.....	8
<b>INSTALLATION .....</b>	<b>9</b>
Shipment Contents .....	9
Unpacking Precautions .....	9
Delivery Inspection.....	9
Skilled Person .....	9
Equipment Description.....	10
Skilled Persons Responsibilities .....	10
Cold Weather Kit.....	10
Installation Checklist .....	11
Generator Placement.....	13
Carbon Monoxide Hazard Safety Placement Requirements.....	14
Fire Hazard Safety Placement Requirements .....	17
Electrical and Fuel Inlet Locations .....	18
Lifting the Generator .....	19
Concrete Anchoring .....	19
Inside Generator Access.....	20
Gaseous Fuel System.....	21
Before Installing Fuel System.....	21
Fuel Consumption .....	22
LP Vapor (Propane) .....	22
Natural Gas .....	22
Fuel Pressure.....	22
Power Loss .....	22
Fuel Pipe Sizing .....	22
Fuel Conversion.....	22
System Connectors.....	23
Grounding the Generator.....	24
Generator Power Connection.....	24
Utility Circuit Connection.....	24
Communication Connections .....	24
Generator AC Connection System .....	25
System Control Panel .....	26
Menu .....	27
General Set Up Screen .....	28
Control Panel Prompts .....	29
Automatic Mode.....	29
General System Parameters .....	29
Advanced Settings Screen.....	30
Service Code Detection System .....	31
Final Installation Considerations .....	31
Engine Oil .....	31
Battery.....	31
Initial Start-Up (No Load) .....	32
<b>OPERATION .....</b>	<b>33</b>
Automatic Operation Sequence .....	33
Utility Voltage Dropout Sensor .....	33
Engine Cool-Down Timer.....	33
Setting Local Date and Time.....	33
Setting Exercise Timer.....	33
<b>EQUIPMENT SPECIFICATIONS.....</b>	<b>34</b>
<b>SCHEMATIC DIAGRAM.....</b>	<b>35</b>

# SAFETY INSTRUCTIONS

## Safety Signs



Explosive material



Flammable material



Electrical shock



Toxic fumes



Rotating parts



Hot surface



Automatic start-up



Corrosive substance



Lift hazard



Refer to instruction manual/booklet

### Safety Alerts

The safety alert symbol indicates a potential personal injury hazard. A signal word, such as DANGER, WARNING, or CAUTION, is used with the alert symbol to designate a degree or level of hazard seriousness. A safety symbol may be used to represent the type of hazard.



#### DANGER

Danger indicates a hazard with a high level of risk which, if not avoided, **will** result in death or serious injury.



#### WARNING

Warning indicates a hazard with a medium level of risk which, if not avoided, **could** result in death or serious injury.



#### CAUTION

Caution indicates a hazard with a low level of risk which, if not avoided, **could** result in minor or moderate injury.

### NOTICE

The manufacturer cannot possibly anticipate every possible circumstance that might involve a hazard. The warnings in this manual, and the tags/decals affixed to the generator are, therefore, not all-inclusive. If you use a procedure, work method or operating technique that the manufacturer does not specifically recommend, you must satisfy yourself that it is safe for you and others. You must also make sure that the procedure, work method or operating technique that you choose does not render the generator unsafe.

 **WARNING**



Running engine produces carbon monoxide, an odorless, poisonous gas. Breathing carbon monoxide could result in death, serious injury, headache, fatigue, dizziness, vomiting, confusion, seizures, nausea or fainting.

**DO**

- **Do** operate this product ONLY outdoors.
- **Do** keep exhaust gas away from any windows, doors, ventilation intakes, soffit vents, crawl spaces, open garage doors or other openings that can allow exhaust gas to enter inside or be drawn into a potentially occupied building or structure.
- **Do** have carbon monoxide detectors installed and maintained indoors according to manufacturer's instructions/recommendations. Smoke alarms cannot detect carbon monoxide gas.

 **WARNING**



Lift Hazard - Heavy object could result in serious injury.

**DO**

- **Do** use lifting pipes as described in **Lifting the Generator**.

**DO NOT**

- **Do not** lift or move generator without assistance.

 **WARNING**



Exhaust heat/gas could ignite combustibles or structures resulting in death or serious injury. Contact with muffler area could cause burns resulting in serious injury. Before installing and/or servicing fuel supply system:

**DO**

- **Do** allow equipment to cool before touching.
- **Do** avoid hot exhaust gases.
- **Do** locate the weatherproof enclosure a minimum of 1.5 m from walls, windows, doors, wall openings, shrubs, or vegetation over 0.3 m in height.
- **Do** locate the weatherproof enclosure a minimum of 1.5 m overhead clearance from any structure, overhang or trees.
- **Do ONLY** use flexible fuel line provided. Connect provided fuel line to generator.
- **Do** have smoke detectors installed and maintained indoors according to the manufacturer's instructions/recommendations. Carbon monoxide detectors cannot detect smoke.
- **Do** allow sufficient room on all sides of generator for maintenance and servicing.

**DO NOT**

- **Do not** use with or substitute the flexible fuel line provided with any other fuel line.
- **Do not** place weatherproof enclosure under a deck or any other type of structure that may confine airflow.
- **Do not** touch hot parts.
- **Do not** smoke around generator.

 **WARNING**



Electrical Shock - Contact with power lines could cause electric shock or burns, resulting in death or serious injury.

**DO NOT**

- **Do not** contact any power lines if using lifting or hoisting equipment.

 **WARNING**



Electrical Shock - Failure to properly ground generator could result in electrocution. Failure to isolate generator from utility power could result in death or serious injury to utility workers due to backfeed of electrical energy. If you must work around a unit while it is operating, stand on an insulated dry surface to reduce risk of shock hazard. Despite the safe design of the generator, operating this equipment imprudently, neglecting its maintenance or being careless could result in death or serious injury.

**DO**

- **Do** have the electrical system meet national rules and regulations of the respective country when generator is installed. This includes the Residual Current Device (RCD).

**DO NOT**

- **Do not** touch bare wires or bare receptacles.
- **Do not** use generator with electrical cords which are worn, frayed, bare or otherwise damaged.
- **Do not** handle generator or electrical cords while standing in water, while barefoot, or while hands or feet are wet.

In case of an accident caused by electrical shock, immediately shut down the source of electrical power and contact the local authorities or emergency response units. Avoid direct contact with the victim.

 **WARNING**



Storage batteries give off explosive hydrogen gas during recharging. The slightest spark will ignite hydrogen and cause explosion, resulting in death or serious injury. Battery electrolyte fluid contains acid and is extremely caustic. Contact with battery contents could cause severe chemical burns. A battery presents a risk of electrical shock and high short circuit current. Before installing and/or servicing battery:

**DO**

- **Do** use tools with insulated handles.
- **Do** wear PPE (Personal Protective Equipment) of protective goggles, rubber apron, rubber boots and rubber gloves.
- **Do** remove all metal objects, such as jewelry, watches or rings.
- **Do** recycle battery through your local recycling company.

**DO NOT**

- **Do not** dispose of battery in a fire.
- **Do not** allow an open flame, spark, heat, or lit cigarette in vicinity during and for several minutes after servicing a battery.
- **Do not** open or mutilate battery.

 **WARNING**



Propane and Natural Gas are extremely flammable and explosive, which could cause burns, fire or explosion resulting in death or serious injury. The slightest spark could ignite these fuels and cause an explosion. LP gas is heavier than air and will settle in low areas. Natural gas is lighter than air and will collect in high areas. Before installing and/or servicing fuel supply system:

**DO**

- **Do** install fuel supply system according to applicable national rules and regulations of the respective country.
- **Do** properly purge and leak test fuel system lines.
- **Do** wipe up any oil spills immediately.
- **Do** keep the area near the generator clean and free of debris.

**DO NOT**

- **Do not** permit leakage.
- **Do not** leave combustible materials in the generator compartment.
- **Do not** operate engine if smell of fuel is present or other explosive conditions exist.
- **Do not** smoke around generator.
- **Do not** have any open flames around generator.

 **CAUTION**



Auto start of Machinery - Installing the 15 Amp fuse could cause the engine to crank and start at any time without warning resulting in minor to moderate injury. Before installing and/or servicing generator:

**DO**

- **Do** observe that the 15A fuse has been removed from the control panel for shipping.
- **Do** remove the 15A fuse before maintaining and/or servicing generator.
- **Do** always press and hold the control board OFF button to prevent sudden start of generator when maintaining and/or servicing.

**DO NOT**

- **Do not** install 15A fuse until all plumbing and wiring has been completed when installing generator.
- **Do not** reinstall 15A fuse until all maintenance and/or service is complete on generator.

## SAFETY RULES AND INFORMATION

---

### Safety Rules

# **NOTICE**

Improper treatment of generator could damage it, shorten its life, and void warranty

1. Read, understand, and follow all instructions in the manual and on the generator before starting equipment.
2. Use generator only for intended uses.
3. If you are not sure that the task you are about to perform can be safely done with the equipment you have chosen, ask a skilled person at your local authorized dealer.
4. Install generator only on level surfaces.
5. Adequate, unobstructed flow of cooling and ventilating air is critical to correct generator operation.
6. The access panels/doors must be installed whenever the generator is running.
7. Remain alert at all times while working on this equipment. Do not work on the equipment when you are physically or mentally fatigued.
8. If connected devices overheat, turn them off and disconnect them from generator.
9. Do not modify generator in any way.
10. Do not expose generator to excessive moisture, dust, dirt, or corrosive vapors.
11. Do not start engine with air cleaner removed or air cleaner cover removed.
12. Do not insert any objects through cooling slots.
13. Do not use the generator or any of its parts as a step. Stepping on the generator could break parts. This may result in dangerous operating conditions from leaking exhaust gases, fuel leakage, oil leakage, etc.
14. Do not allow unqualified persons or children to operate or service generator.
15. After the system is installed, the generator may crank and start at any time, without warning. To prevent possible injury while working on equipment, depress the OFF button on the generator control panel. Then remove the 15 A fuse from the generator control panel.



## INSTALLATION

### Shipment Contents

The generator is supplied with:

- Oil (5W30 Synthetic)
- Flexible steel fuel line
- Installation Instructions
- User's Instructions
- Spare access keys
- Spare 15 A ATO-type fuse
- Two tamper proof plugs

### Not Included:

- Carbon monoxide detector(s)
- Smoke detector(s)
- Starting battery
- Connecting wire and conduit
- Fuel supply valves/plumbing
- Two 1.5 m lengths of 25 mm (Outer Diameter) and minimum 2.5 mm wall thickness steel pipe
- Hole punches for 1.6 mm steel
- Cyanoacrylate glue
- Concrete slab (if needed)
- Pipe thread sealant

### Unpacking Precautions

The generator is shipped ready for installation. Avoid damage from dropping, bumping, collision, etc. Store and unpack carton with proper side up, as noted on the shipping carton.

### Delivery Inspection

After removing the carton, carefully inspect the generator for any damage that may have occurred during shipment.

If loss or damage is noted at time of delivery, have the person(s) making the delivery note all damage on the freight bill and affix his signature under the consignor's memo of loss or damage. If loss or damage is noted after delivery, separate the damaged materials and contact the carrier for claim procedures. Parts damaged in shipping are not warranted.

This manual is specifically targeted for the skilled person.

### Skilled Person

Individual with relevant technical education, training and/or experience enabling him or her to perceive risks and to avoid hazards occurring during use of a product.



### CAUTION



Auto start of Machinery - Installing the 15 Amp fuse could cause the engine to crank and start at any time without warning resulting in minor to moderate injury. Before installing and/or servicing generator:

#### DO

- **Do** observe that the 15A fuse has been removed from the control panel for shipping.
- **Do** remove the 15A fuse before maintaining and/or servicing generator.
- **Do** always press and hold the control board OFF button to prevent sudden start of generator when maintaining and/or servicing.

#### DO NOT

- **Do not** install 15A fuse until all plumbing and wiring has been completed when installing generator.
- **Do not** reinstall 15A fuse until all maintenance and/or service is complete on generator.

## INSTALLATION cont.

### Equipment Description

This product is intended for use as an optional system which provides an alternate source of electric power and to serve loads such as heating, refrigeration systems, and communication systems that, when stopped during any power outage, could cause discomfort or inconvenience.

Every effort has been made to ensure that information in this manual is accurate and current. However, we reserve the right to change, alter, or otherwise improve the product and this document at any time without prior notice.

### **NOTICE**

Only skilled persons should attempt generator installations. Installations must strictly comply with all applicable national rules and regulations of the respective country.

### Skilled Persons Responsibilities

- Read and follow the instructions given in the installation instructions.
- The generator warranty is VOID unless the system is installed by skilled persons.
- Carbon monoxide detector(s) **MUST** be installed and maintained indoors according to the manufacturer's instructions/recommendations. Smoke alarms cannot detect carbon monoxide gas.
- Smoke detector(s) **MUST** be installed and maintained indoors according to the manufacturer's instructions/recommendations. Carbon monoxide alarms cannot detect smoke.
- Any deviations from manufacturer's recommendations/instructions will void warranty.
- Read and observe the safety rules.
- Installation must strictly comply with all applicable national rules and regulations of the respective country.
- Allow sufficient room on all sides of the generator for maintenance and servicing.

### Cold Weather Kit

It is **HIGHLY RECOMMENDED** to install a Model 6030A Cold Weather Kit (includes one oil warmer and one battery warmer) on the generator for operation below  $-1^{\circ}\text{C}$ .

For cold weather areas (below  $-18^{\circ}\text{C}$ ) it is also recommended to use a BCI-24F, wet lead-acid battery with a minimum rating of 800 CCA.

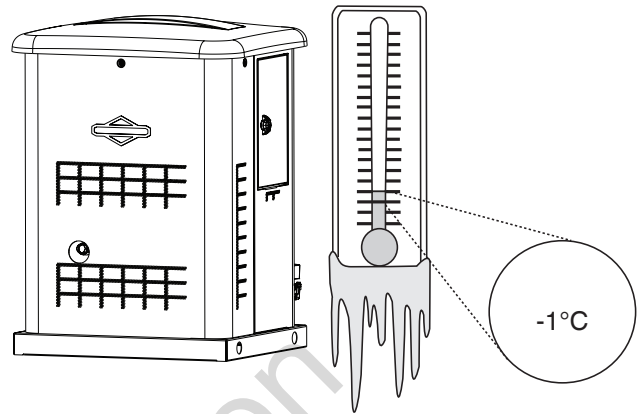

**Figure 1.** Cold Weather Kit

## Installation Checklist

Proper installation of the generator requires the completion of the following tasks. Fill out the information below and give to the user.

### Carbon Monoxide (CO) Detector

- Carbon Monoxide (CO) detector(s) installed and in working order.
- Smoke detector(s) installed and in working order.

### Placement

- Required permits have been obtained.
- Generator is placed in an area free from Carbon Monoxide (CO) buildup. See **Carbon Monoxide Hazard Safety Placement Requirements**.
- Generator is placed in an area free from potential water damage.
- Generator is placed in an area free from utility and other home systems.
- Generator is placed in a debris free zone.
- Generator is placed on flat ground with provisions for water drainage.

### Fuel

- Generator is connected to fuel source with flexible fuel line, has no fuel leaks and conforms to national rules and regulations of the respective country. See **Gaseous Fuel System**.
- Proper fuel pressure has been measured with all gas appliances operating. See **Gaseous Fuel System**.
- Fuel system has been configured for the proper fuel supply: Natural gas (NG) or liquefied petroleum (LP). See **Fuel Conversion**.
- Fuel type: (circle one) NG LP
- Fuel pipe size used: (circle one) 19mm 25mm 32mm 38mm
- Fuel pressure at fuel inlet port with generator on and at full load and all gas appliances turned on and operating \_\_\_\_\_.

### Electrical

- Generator is connected to Automatic Transfer Switch. See **Generator AC Connection System**.
- Generator is grounded. See **Grounding the Generator**.
- Generator is connected to the transfer switch with the specified wiring. See **Utility Circuit Connection** and **Communication Connections**.
- Generator is connected to the transfer switch with the specified wiring. #0.82 mm<sup>2</sup> twisted pair wiring from the generator control panel to the transfer switch is installed in a separate conduit from high voltage wires unless the insulation rating on all wiring is rated for 600V. See **Communication Connections**.
- Dipswitches in most transfer switches must be set to correspond to the wattage of the generator. See **Transfer Switch Operator/Installation Manual**.

### Operation

- Cold weather kit is installed in temperatures below -1°C. See **Cold Weather Kit**.
- Correct battery type is installed and fully charged. See **Final Installation Considerations**.
- Generator engine oil level is at full mark. See **Final Installation Considerations**.
- All circuit breakers are in the ON position (Generator and Transfer Switch).
- Utility was shut off to test the operation of generator and transfer switch. Note any service codes and make corrections as required.
- AC Voltage Output \_\_\_\_\_.
- Frequency Output \_\_\_\_\_.

### Owner Information

Name: \_\_\_\_\_

Address: \_\_\_\_\_

Phone/e-mail: \_\_\_\_\_

### Generator Information

Generator Model: \_\_\_\_\_

Generator Serial Number: \_\_\_\_\_

### Installing Contractor Information

Name: \_\_\_\_\_

Address: \_\_\_\_\_

Phone/FAX: \_\_\_\_\_

Electrician: \_\_\_\_\_

Signature: \_\_\_\_\_

Plumber: \_\_\_\_\_

Signature: \_\_\_\_\_

### Inspector Information

Name: \_\_\_\_\_

Address: \_\_\_\_\_

Title: \_\_\_\_\_

Inspection Date: \_\_\_\_\_

**This generator has been installed per the manufacturer's instructions:**

Installing Contractor Signature: \_\_\_\_\_

Date: \_\_\_\_\_

This page intentionally left blank

Not for  
Reproduction

## INSTALLATION cont.

### Generator Placement

Before installing generator, consult with user and convey the following requirements, which must be satisfied before the installation is complete. There are two equally important safety concerns in regards to carbon monoxide poisoning and fire. There are also several general location guidelines that must be met before the installation is considered complete.

#### **NOTICE**

Allow sufficient room on all sides of the generator for maintenance and servicing when choosing a location for placement

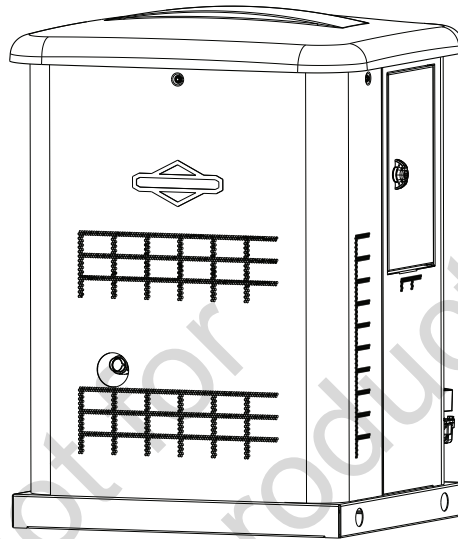

**Figure 2.** Exhaust side of generator

Carbon Monoxide Hazard Safety Placement Requirements

**NOTICE**

This section is for Carbon Monoxide Hazard Safety Placement Only. Satisfying the generator placement requirements for the carbon monoxide hazard does not guarantee that fire safety hazard placement requirements are met. Please refer to **Fire Hazard Safety Placement Requirements**

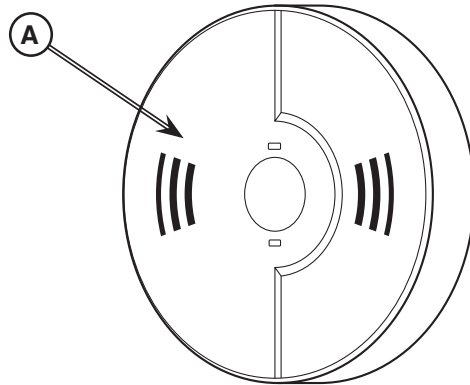

Figure 3 Carbon Monoxide Detector

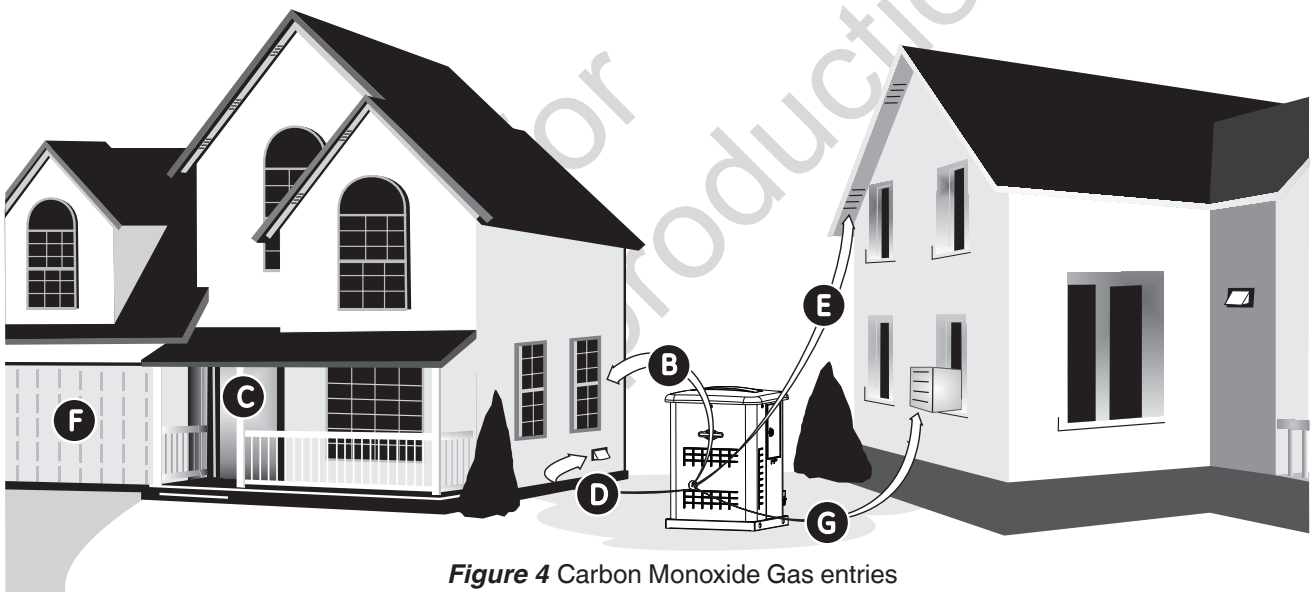

Figure 4 Carbon Monoxide Gas entries

The letters shown above in Figure 4 indicate **POTENTIAL** points of entry for Carbon Monoxide Gas.

**A. Carbon Monoxide Detector(s):** MUST be installed and maintained indoors according to manufacturer's instructions/recommendations.

**Ensure exhaust gas is kept away from:**

- B. Windows**
- C. Doors**
- D. Ventilation Intakes**
- E. Soffit vents**
- F. Garage doors**
- G. Crawl spaces or other openings that can allow exhaust gas to enter or be drawn into potentially occupied building or structure.**

## INSTALLATION cont.

All fossil fuel burning equipment, such as generators, contain carbon monoxide (CO) gas in the engine exhaust. CO gas is odorless, colorless, tasteless, and is unlikely to be noticed until a person is overcome with carbon monoxide poisoning.

**WARNING**



Running engine produces carbon monoxide, an odorless, poisonous gas. Breathing carbon monoxide could result in death, serious injury, headache, fatigue, dizziness, vomiting, confusion, seizures, nausea or fainting.

**DO**

- **Do** operate this product **ONLY** outdoors.
- **Do** keep exhaust gas away from any windows, doors, ventilation intakes, soffit vents, crawl spaces, open garage doors or other openings that can allow exhaust gas to enter inside or be drawn into a potentially occupied building or structure.
- **Do** have carbon monoxide detectors installed and maintained indoors according to manufacturer's instructions/recommendations. Smoke alarms cannot detect carbon monoxide gas.

Breathing in CO gas can result in death. The following requirements must be included as part of the generator installation:

- Install generator outdoors in an area that will not accumulate deadly exhaust gas.
- **DO NOT** install generator where exhaust gas could accumulate and enter inside or be drawn into a potentially occupied building or structure.
- Manufacturer requires a carbon monoxide detector(s) in the home. Carbon monoxide detector(s) **MUST** be installed and maintained indoors according to manufacturer's instructions/recommendations. A CO detector is an electrical device that detects hazardous levels of CO. When there is buildup of CO, the device will alert the occupants by flashing visual indicator light and alarm. Smoke alarms cannot detect CO gas. The CO detector must comply with European Standard EN 50291 and carry the CE mark. The CE mark certifies that the CO detector is compliant with European Standards for electrical safety.

- The neighbor's home may be exposed to the engine exhaust from the generator and must be considered when installing the generator.
- Direct the generator exhaust away from or parallel to the building or structure.
- **DO NOT** direct the generator exhaust towards a potentially occupied building, structure, window, doors, ventilation intakes, soffit vents, crawl spaces, open garage doors or other openings where exhaust gas could accumulate and enter inside or be drawn into potentially occupied building or structure.
- **DO NOT** place generator in any area where leaves or debris normally accumulate.
- Position generator in an area where winds will carry the exhaust gas away from any potentially occupied building or structure.
- Place generator in a prepared location that is flat and has provisions for water drainage.
- Install the generator in a location where sump pump discharge, rain gutter downspouts, roof run-off, landscape irrigation, or water sprinklers will not flood the generator or spray the enclosure and enter any air inlet or outlet openings.
- Install the generator where it will not affect or obstruct any services including covered, concealed and underground, such as telephone, electric, fuel, irrigation, air conditioning, cable, septic, sewer, well, etc.
- Install the generator where leaves, grass, snow, etc. will not obstruct air inlet or outlet openings. If prevailing winds will cause blowing or drifting, you may need to construct a windbreak to protect the generator.

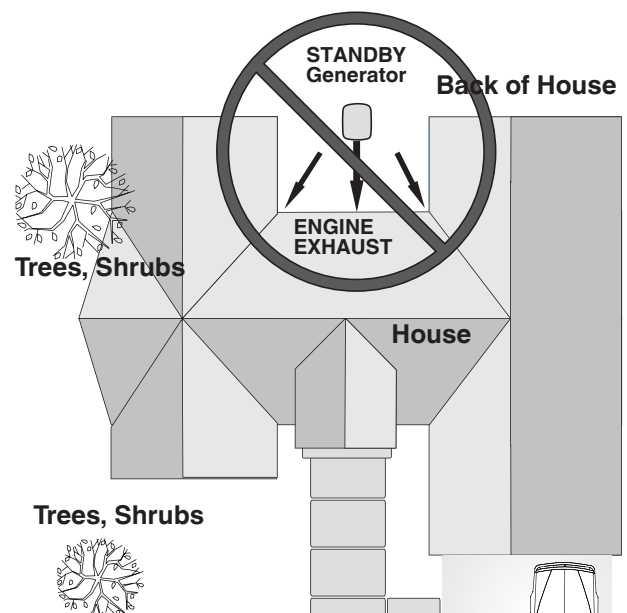

Figure 5 Where **Not** to Place Generator

 **WARNING**



Exhaust heat/gas could ignite combustibles or structures resulting in death or serious injury. Contact with muffler area could cause burns resulting in serious injury. Before installing and/or servicing fuel supply system:

**DO**

- **Do** allow equipment to cool before touching.
- **Do** avoid hot exhaust gases.
- **Do** locate the weatherproof enclosure a minimum of 1.5 m from walls, windows, doors, wall openings, shrubs, or vegetation over 0.3 m in height.
- **Do** locate the weatherproof enclosure a minimum of 1.5 m overhead clearance from any structure, overhang or trees.
- **Do ONLY** use flexible fuel line provided. Connect provided fuel line to generator.
- **Do** have smoke detectors installed and maintained indoors according to the manufacturer's instructions/recommendations. Carbon monoxide detectors cannot detect smoke.
- **Do** allow sufficient room on all sides of generator for maintenance and servicing.

**DO NOT**

- **Do not** use with or substitute the flexible fuel line provided with any other fuel line.
- **Do not** place weatherproof enclosure under a deck or any other type of structure that may confine airflow.
- **Do not** touch hot parts.
- **Do not** smoke around generator.

This side of page intentionally left blank



Fire Hazard Safety Placement Requirements

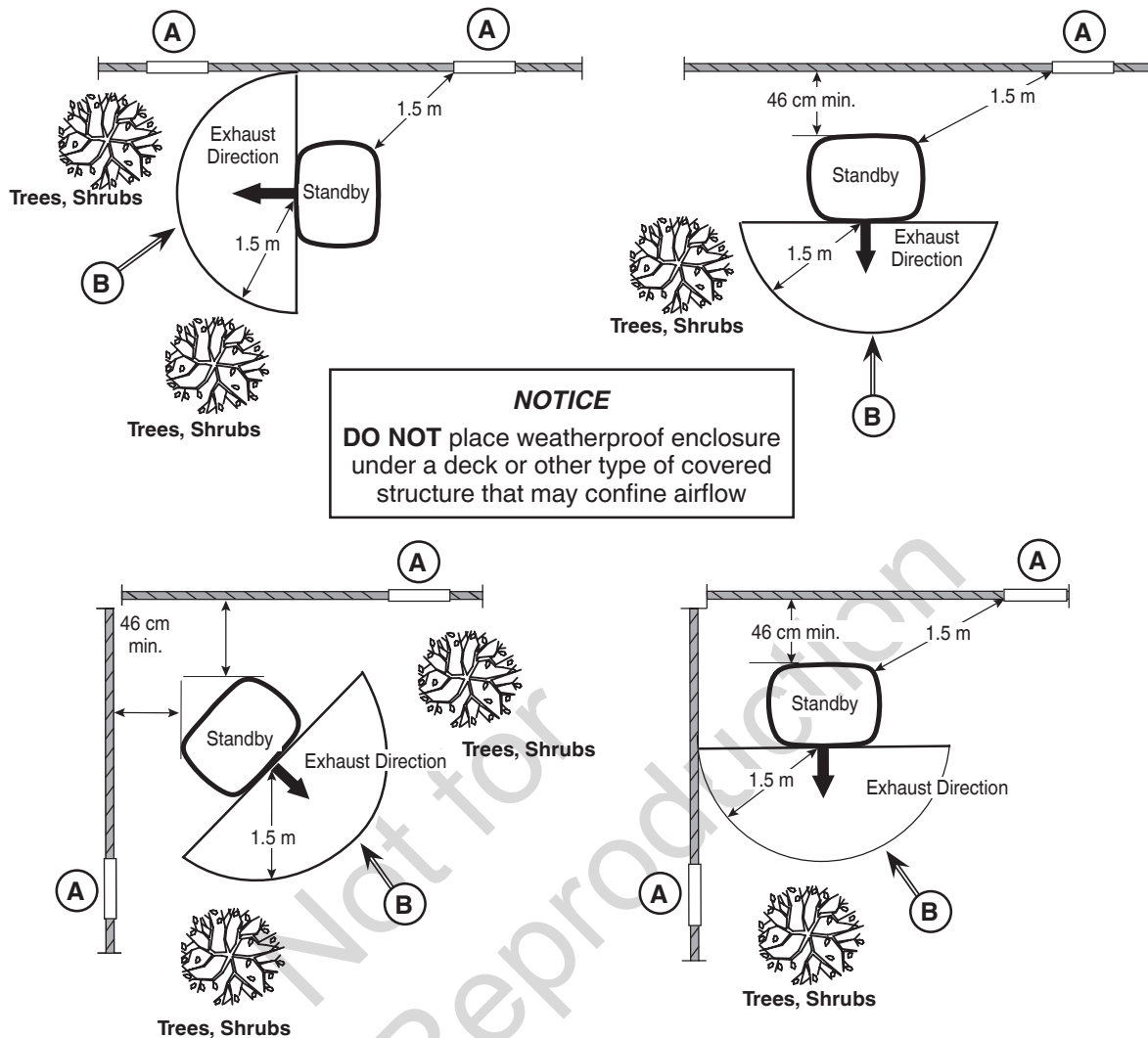

Figure 6 Minimum Installation Clearances

- A. Generator's weatherproof enclosure must be a minimum of 1.5 m from windows, doors, any wall openings, shrubs, or vegetation over 0.3 m in height.
- B. Exhaust outlet side of weatherproof enclosure must have at least 1.5 m minimum clearance from any structure, overhang or trees.
- C. Generator's weatherproof enclosure must have a minimum of 1.5 m overhead clearance from any structure, overhang or trees.

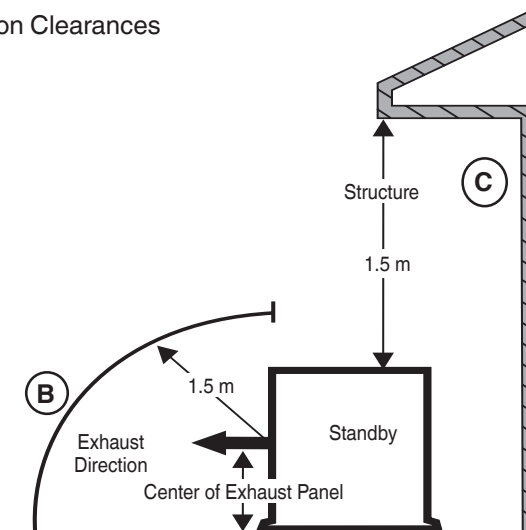

Figure 7 Minimum Installation Clearances

## INSTALLATION cont.

### Electrical and Fuel Inlet Locations

The 3/4 inch NPT (National Pipe Thread – United States standard for tapered threads) fuel inlet (A) and electrical inlet locations are shown in the figure below.

A knock-out is provided for the electrical inlet. This inlet may be enlarged or supplemented to accommodate a maximum conduit size of 38 mm. Ensure that the installed conduit enters the generator in the zone (B) shown in the figure below.

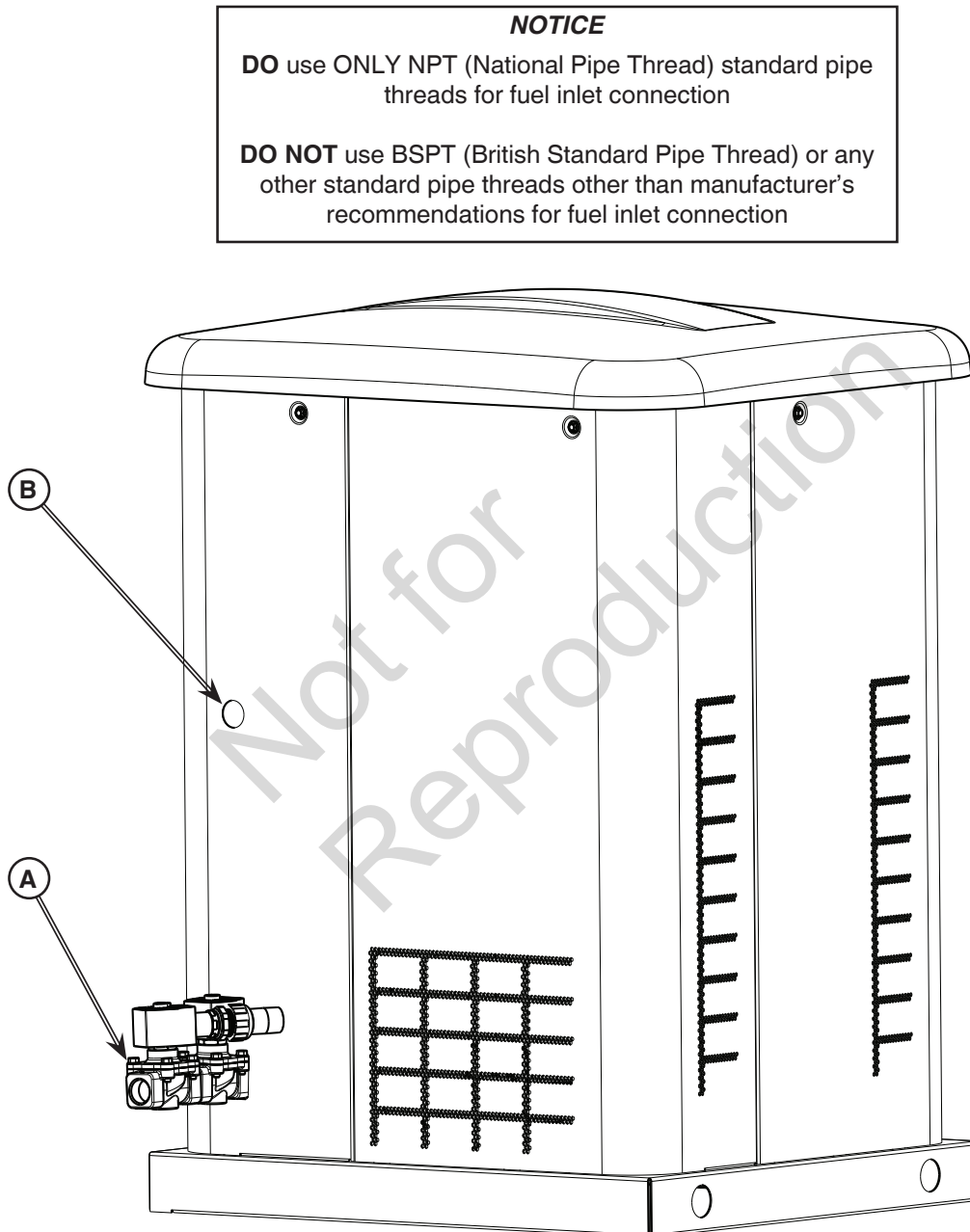

**Figure 8** Electrical And Fuel Inlet Locations

## INSTALLATION cont.

### Lifting the Generator

**WARNING**



Lift Hazard - Heavy object could result in serious injury.

**DO**

- **Do** use lifting pipes as described in *Lifting the Generator*.

**DO NOT**

- **Do not** lift or move generator without assistance.

**WARNING**



Electrical Shock - Contact with power lines could cause electric shock or burns, resulting in death or serious injury.

**DO NOT**

- **Do not** contact any power lines if using lifting or hoisting equipment.

**NOTICE**

**Do not** lift unit by roof as this will damage the generator and void warranty

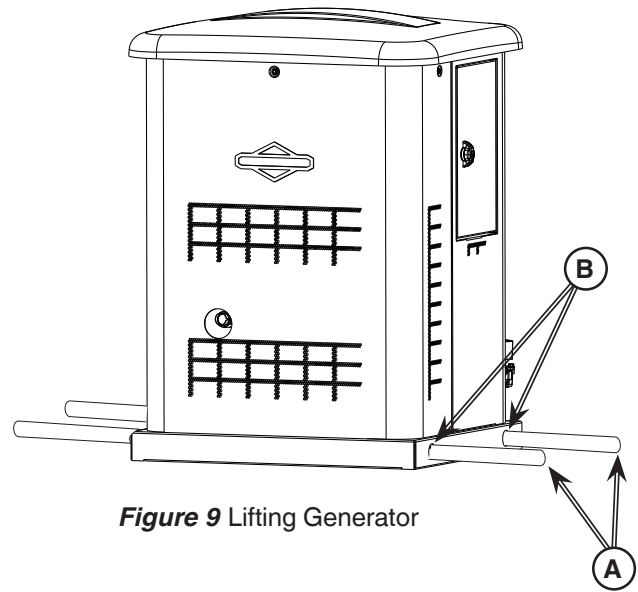

Figure 9 Lifting Generator

#### Concrete Anchoring

In areas prone to high winds or storms, it is recommended to anchor the generator to concrete. The concrete anchors must be rated to hold 363 kg. There are three 11 mm hole locations (C) around the base of the generator in which to anchor the unit. See figure below.

**NOTICE**

Concrete slab is not required unless mandated by national rules and regulations of the respective country

Use proper tools and equipment in all phases of handling and moving the generator.

Two 1.5 m lengths of steel pipe (A), supplied by the installer, are required to lift the generator. Steel pipe to be 25 mm outer diameter and a minimum of 2.5 mm wall thickness. Insert pipes through the lifting holes (B) located in the generator's base.

If using hoisting equipment to lift the generator, attach the chains or cables to the lifting pipes with a spreader bar. The proper use of a spreader bar will prevent damage to the generator enclosure.

**DO NOT** touch the roof when lifting the generator.

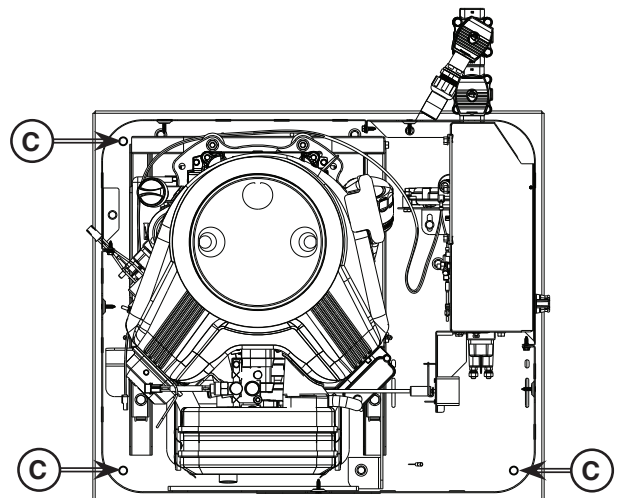

Figure 10 Anchor Holes

## INSTALLATION cont.

### Inside Generator Access

The generator is equipped with an enclosure that has access panels as shown in figure below. The generator roof (A) must be removed to gain access to the front panel (B).

### To Remove the Roof (A)

1. Remove the five screws that secure the roof to the generator.
2. Carefully lift and remove roof from the generator.

### To Remove the Front Panel (B)

1. Remove the roof.
2. Remove the two screws that secure the panel to the generator.
3. Lift and flex the panel outward and off base. Use caution not to damage the battery box.

### To Open the Access Panel (C)

1. Insert key into lock of access panel.
2. Turn key one quarter turn clockwise.

(A) Roof Panel is used to access:

- Engine Oil Dipstick
- Air Filter
- Fuel Selection Electrical Connection

(B) Front Panel is used to access:

- Battery Compartment
- Engine Oil Drain Hose
- Engine Oil Filter
- Engine Valve Cover
- Spark Plugs

(C) Access Panel is used to access:

- Circuit Breaker
- 15A fuse
- Control Panel

### NOTICE

Roof should be installed at all times unless servicing generator

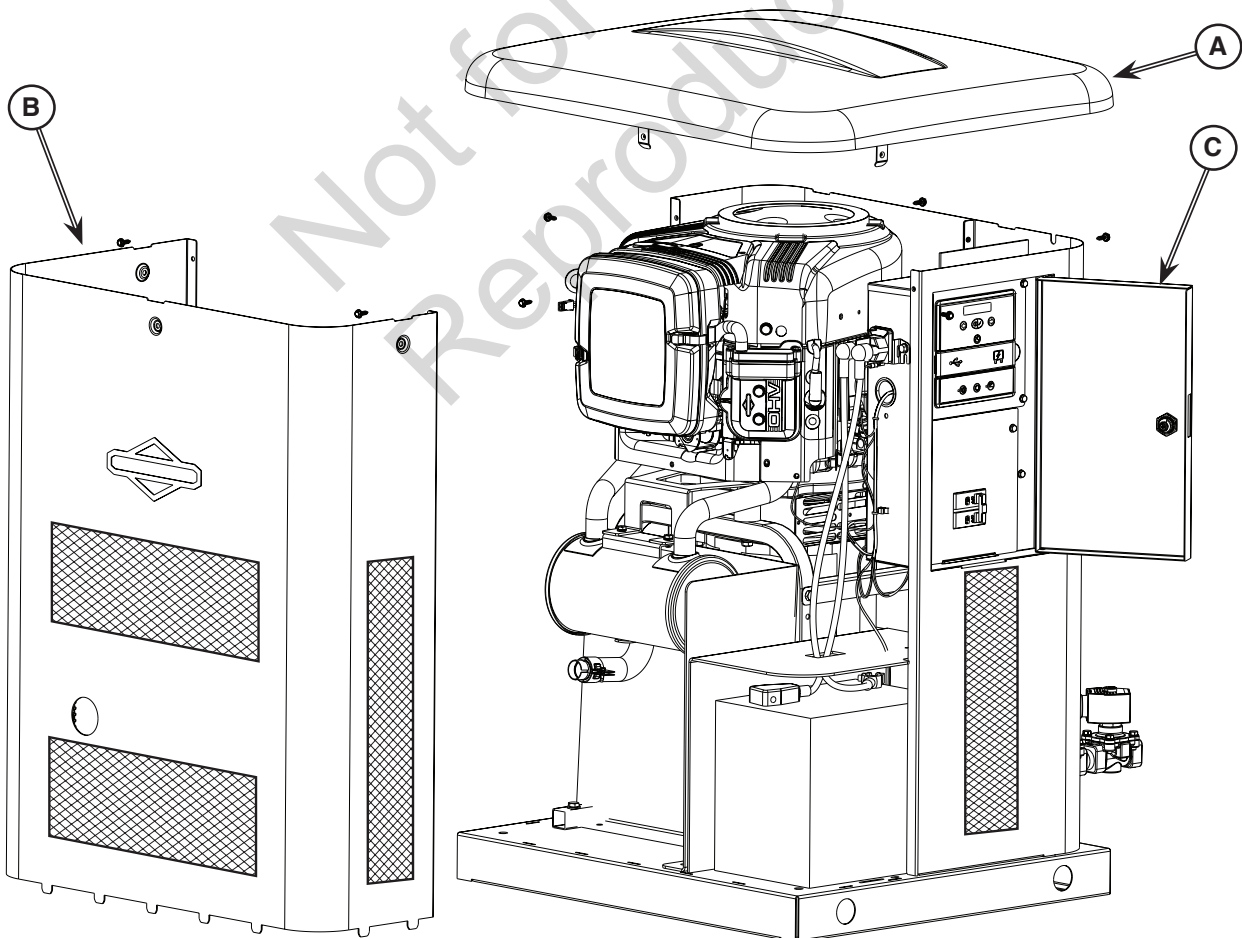

Figure 11 Front View

## INSTALLATION cont.

### Gaseous Fuel System

#### NOTICE

Use the following information to plan the gaseous fuel system installation. This information **DOES NOT** override applicable national rules and regulations of the respective country. Consult with your local fuel supplier or Fire Marshall if questions or problems arise

#### ! WARNING



Propane and Natural Gas are extremely flammable and explosive, which could cause burns, fire or explosion resulting in death or serious injury. The slightest spark could ignite these fuels and cause an explosion. LP gas is heavier than air and will settle in low areas. Natural gas is lighter than air and will collect in high areas. Before installing and/or servicing fuel supply system:

#### DO

- **Do** install fuel supply system according to applicable national rules and regulations of the respective country.
- **Do** properly purge and leak test fuel system lines.
- **Do** wipe up any oil spills immediately.
- **Do** keep the area near the generator clean and free of debris.

#### DO NOT

- **Do not** permit leakage.
- **Do not** leave combustible materials in the generator compartment.
- **Do not** operate engine if smell of fuel is present or other explosive conditions exist.
- **Do not** smoke around generator.
- **Do not** have any open flames around generator.

#### Before Installing Fuel System

Consult with the user regarding any technical considerations that might affect their installation plans. The entire flexible steel fuel line must be visible for periodic inspection and must not be concealed within nor contact or run through any wall, floor, or partition. The piping should be of a material that conforms to national rules and regulations of the respective country, rigidly mounted and protected against vibration.

Piping should be protected from physical damage where it passes through flower beds, shrub beds, and other cultivated areas where damage could occur.

1. Install the flexible steel fuel line (**B**) (supplied) between the generator fuel inlet port (**A**) and rigid piping. This will prevent thermal expansion, contraction, or any generator movement from causing excessive stress on the piping material.
2. A union (**C**) or flanged connection shall be provided downstream to permit removal of generator.
3. A manometer port should be provided (**D**) to enable measurement of fuel pressure. A digital manometer, Part Number 19495, is available at your local Briggs & Stratton authorized service provider. When the initial test runs are completed, the manometer is removed and the port is plugged.
4. The termination of hard piping should include a sediment trap (**F**) where condensate is not likely to freeze. Where formation of hydrates or ice is known to occur, piping should be protected against freezing.
5. A minimum of one accessible, approved manual shutoff valve (**E**) shall be installed in fuel supply line per national rules and regulations of the respective country.

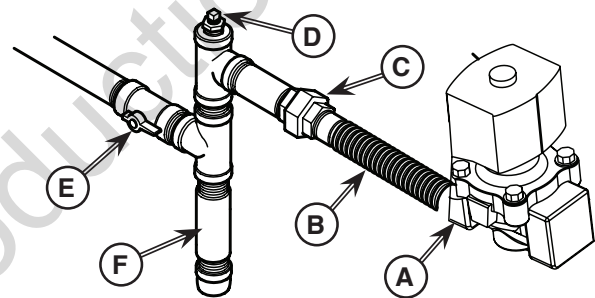

Figure 12 Gaseous Fuel System\*

\*Illustration is reference only. Your installation may differ

#### NOTICE

The supplied flexible steel fuel line is not to be installed underground or in contact with the ground

Piping must be of the correct size to maintain the required supply pressures and volume flow under varying generator load conditions with all gas appliances connected to the fuel system turned on and operating.

Use a pipe sealant or joint compound approved for use with NG/LPG on all threaded fittings to reduce the possibility of leakage.

Where local weather conditions include earthquake, tornado, unstable ground, or flood hazards, special consideration shall be given to increase strength and flexibility of piping supports and connections.

Purge and leak test the installed piping in accordance with applicable national rules and regulations of the respective country.

## INSTALLATION cont.

### Fuel Consumption

Estimated fuel supply requirements for natural gas and LP vapor fuels are shown below.

#### NOTICE

Generator is configured for natural gas (NG) at the factory

### LP Vapor (Propane)

		8 kVA
Full Load	kg/Hr	3.1
	m <sup>3</sup> /Hr	1.7
	L/Hr (liquid)	6.2
	MJ/Hr	156
1/2 Load	kg/Hr	2.0
	m <sup>3</sup> /Hr	1.1
	L/Hr (liquid)	4.0
	MJ/Hr	101
Exercise	kg/Hr	1.4
	m <sup>3</sup> /Hr	0.8
	L/Hr (liquid)	2.8
	MJ/Hr	69

### Natural Gas

		6.5 kVA
Full Load	m <sup>3</sup> /Hr	3.8
	MJ / Hr	140
1/2 Load	m <sup>3</sup> /Hr	2.4
	MJ / Hr	87
Exercise	m <sup>3</sup> /Hr	1.4
	MJ / Hr	51

### Fuel Pressure

Fuel supply pressure at the generator's fuel inlet port should be at the following levels at full load with all gas appliances turned on and operating:

NG: 8.5 - 18 mbar (3.5 - 7 inwc)

LP: 27 - 35 mbar (11 - 14 inwc)

Ensure that all gas line shutoff valves are OPEN and that adequate fuel pressure is available whenever automatic operation of generator is desired.

### Power Loss

Air density is less at high altitudes, resulting in less available engine power. Specifically, engine power will decrease 3.5% for each 300 m above sea level and 1% for each 5.6°C above 25°C.

### Fuel Pipe Sizing

There are numerous on-line or otherwise published references for fuel pipe sizing.

Consider the specific gravity of gas and compensate for a nominal amount of restriction from bends, fittings, etc. Refer to federal and local codes for guidance if an unusual number of fittings, bends, or other restrictions are used.

### Tamper Proof Plug Installation / Fuel Conversion

1. Close manual fuel shut-off valve.
2. Open control board access door.
3. Set generator's circuit breaker to its **OFF** position.
4. Press and hold the control board **OFF** button.
5. Remove the 15A fuse from control board.
6. Remove generator roof.
7. To convert the fuel to liquefied petroleum vapor (LP), connect the fuel select solenoid by joining the two-pin electrical connectors (**A**).
8. Install tamper proof plugs supplied with generator. Plugs fit over mixer screws (**B**) with convex sides facing out.
9. Secure each plug with a drop of cyanoacrylate glue.
10. Reinstall generator roof.
11. Reinsert the 15A fuse in control board.
12. Press and hold the control board **AUTO** button.
13. Set generator's circuit breaker to its **ON** position.
14. Close and lock control board access door.
15. Open manual fuel shut-off valve.

The system is now ready to operate automatically using LP vapor fuel.

• **NOTE:** NG Settings from factory are:

- Screw C: 4 turns
- Screw D: 1/2 turn

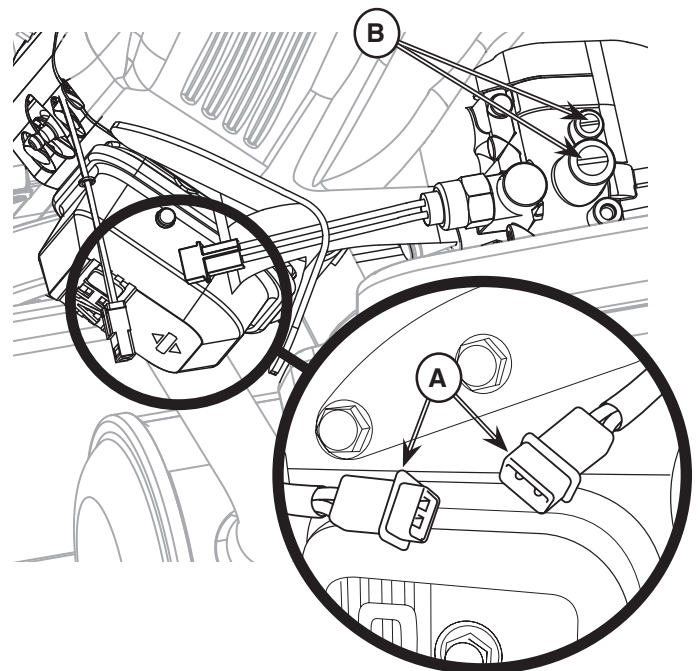

Figure 13 Tamper Proof Plugs and Fuel Conversion

**INSTALLATION** cont.

**System Connectors**

**NOTICE**

System connections must be made by a skilled person

**NOTICE**

Torque terminal block screws to 0.5 Nm. Torque circuit breaker connections to 5 Nm

Low voltage connections to signal fault contacts, transfer switch communication and auxiliary 12VDC power are made via field connection terminal block in control board area.

**A. Utility Connection** - Used to connect utility 230VAC from fuse block in automatic transfer switch to the control board. Connect only one wire per terminal. Use 2.08 mm<sup>2</sup> minimum, 300V, 90°C copper wire. Torque terminals to 0.5Nm.

**B. Fault Contacts** - Use NO, COM and NC to connect an alarm to alert user in case of a fault. Contacts reverse state (NO goes to NC and vice versa) upon a fault condition.

**C. Transfer Switch Communications (TxRx and TxRx GND)** - Connect to transfer switch control board for communication interface.

**D. +LED and GND Connection** - A model 6144 Remote LED Kit is available to monitor system status.

**E. Eight Pin Terminal Block** - Used to connect signal wires to the control board. Connect only one wire per terminal. Torque terminals to 0.5Nm.

**F. Power Connection (Line 1 and Line 2)** - Power connection to transfer switch. Use 13.3 mm<sup>2</sup> minimum, 300V, 90°C copper wire. Torque terminals to 5Nm.

**G. Ground Connection** - Ground connection to transfer switch. Use 13.3 mm<sup>2</sup> minimum, 300V, 90°C copper wire. Torque terminals to 5Nm.

**NOTICE**

Fasten only one wire to each connector screw on terminal block

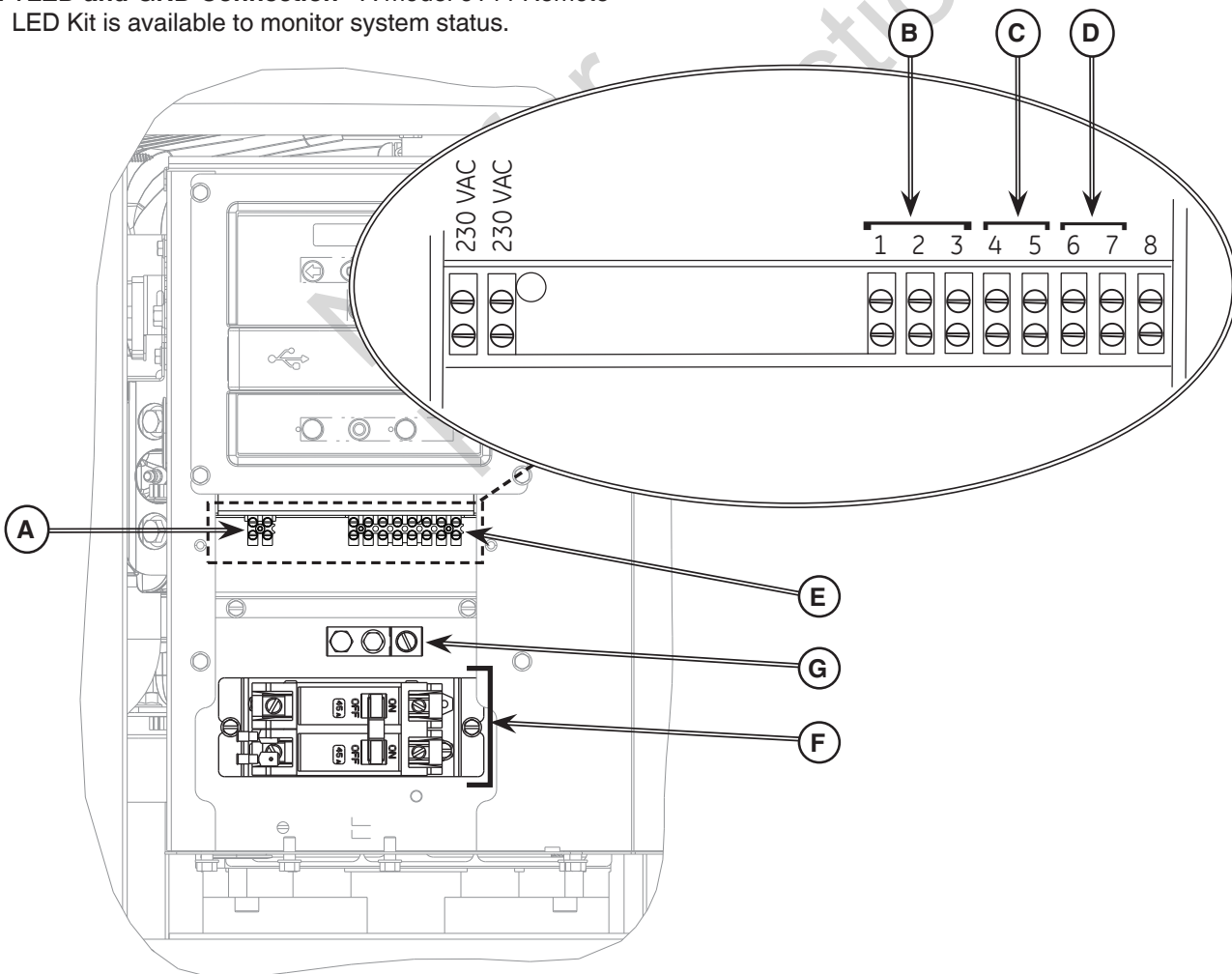

**Figure 14** System Connectors

## INSTALLATION cont.

### Grounding the Generator

The generator must be installed as part of a system that includes model 071060 Automatic Transfer Switch. Additional grounding to earth at the generator is not required, unless mandated by applicable national rules and regulations of the respective country. Any grounding at generator must use metal piercing lock washers (or equivalent) and approved terminals installed per terminal supplier's instructions. Grounding must comply with applicable national rules and regulations of the respective country.

### Generator Power Connection

Connect generator power output Line 1, Line 2, Ground to the corresponding Line 1, Line 2, Ground in the transfer switch.

### Utility Circuit Connection

The 230V power supply from the transfer switch utility provides power to the generator controller, charges the battery and provides power to the optional battery and oil warmers. Install the leads for the power supply per applicable national rules and regulations of the respective country. When power on these leads is lost, the generator will start.

### Communication Connections

Connect the applicable communication leads to the automatic transfer switch as shown in the table below.

Pin Number	Description	Wire Type	Connect To	Notes
1	Normally Open	0.82 mm <sup>2</sup> twisted pair conductors no longer than 61 m, 300V, 90°C copper wire		For Optional Alarm
2	Common	0.82 mm <sup>2</sup> twisted pair conductors no longer than 61 m, 300V, 90°C copper wire		For Optional Alarm
3	Normally Closed	0.82 mm <sup>2</sup> twisted pair conductors no longer than 61 m, 300V, 90°C copper wire		For Optional Alarm
4	Transfer Switch Communication	0.82 mm <sup>2</sup> twisted pair conductors no longer than 61 m, 300V, 90°C copper wire	TxRx on transfer switch board	MUST CONNECT
5	Transfer Switch Communication Ground	0.82 mm <sup>2</sup> twisted pair conductors no longer than 61 m, 300V, 90°C copper wire	TxRx Ground on transfer switch board	MUST CONNECT
6	+LED	0.82 mm <sup>2</sup> twisted pair conductors no longer than 61 m, 300V, 90°C copper wire	Red wire on fault indicator plate	For Optional Fault Indication
7	Ground	0.82 mm <sup>2</sup> twisted pair conductors no longer than 61 m, 300V, 90°C copper wire	Black wire on fault indicator plate	For Optional Fault Indication Ground
8	Not Used	N/A	N/A	N/A



**INSTALLATION** cont.

**Generator AC Connection System**

A single-phase, two wire with ground AC connection system is used in the generator. A complete schematic diagram is in the back of this manual. See **Table of Contents** for page number.

**NOTICE**  
Generator must be used **ONLY** with transfer switch Part Number 071060

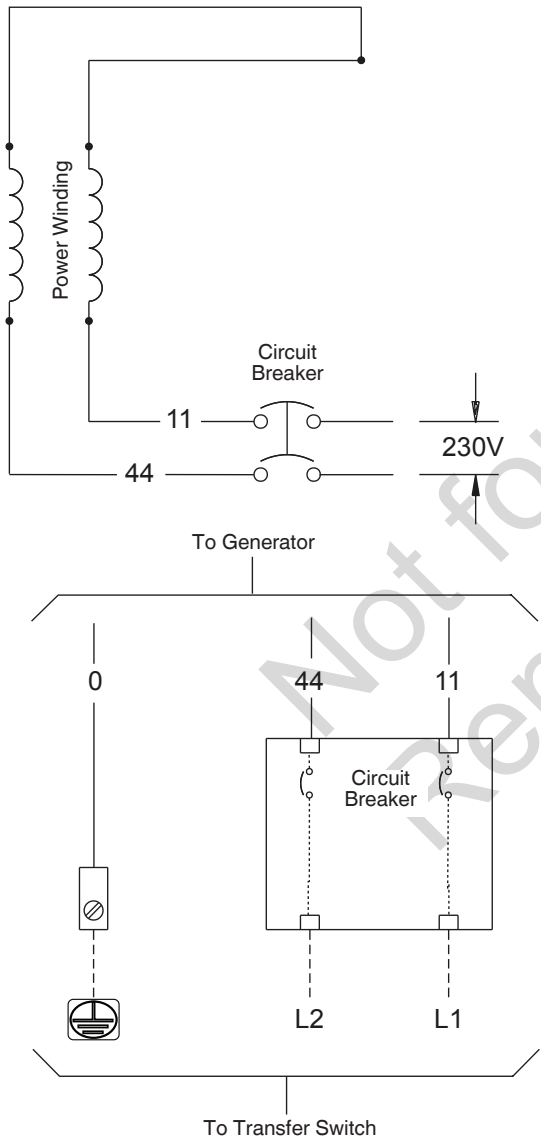

**Figure 15** AC Connections

**WARNING**



Electrical Shock - Failure to properly ground generator could result in electrocution. Failure to isolate generator from utility power could result in death or serious injury to utility workers due to backfeed of electrical energy. If you must work around a unit while it is operating, stand on an insulated dry surface to reduce risk of shock hazard. Despite the safe design of the generator, operating this equipment imprudently, neglecting its maintenance or being careless could result in death or serious injury.

**DO**

- **Do** have the electrical system meet national rules and regulations of the respective country when generator is installed. This includes the Residual Current Device (RCD).

**DO NOT**

- **Do not** touch bare wires or bare receptacles.
- **Do not** use generator with electrical cords which are worn, frayed, bare or otherwise damaged.
- **Do not** handle generator or electrical cords while standing in water, while barefoot, or while hands or feet are wet.

In case of an accident caused by electrical shock, immediately shut down the source of electrical power and contact the local authorities or emergency response units. Avoid direct contact with the victim.

## INSTALLATION cont.

### System Control Panel

The generator control panel, located inside generator housing, is shown in the figure below.

**A. Menu/Programming Navigation Buttons** - See *Menu* section for details.

**B. USB Port** - Skilled Person Use ONLY.

**C. Generator Operation Control Buttons** -

 **AUTO** - Normal operating position. Press and hold button to put generator into Automatic Mode. If an utility power outage is sensed, the generator will start. When utility power is restored, auto lets the engine stabilize internal temperatures, shuts off the generator, and waits for the next utility outage.

**AUTO LED** - LED lights when unit is placed into AUTO mode. LED blinks if exercise cycle is not set or is set to OFF.

 **OFF** - Turns off running generator, prevents it from starting, and resets any detected fault conditions. To reset service codes, press and hold OFF button for more than 5 seconds.

 **MANUAL** - Manually starts the generator.

**D. 15 Amp Fuse** - Protects the generator DC control circuits. If the fuse has 'blown' (melted open) or was removed the engine cannot crank or start. Replace the fuse using only an identical ATO 15A fuse. One spare fuse is supplied with the unit.

**E. Cover** - This protective cover must be opened to access the fuse and the USB port.

**F. Digital Display** - Displays generator mode, menu options, service codes, and service engine indicators.

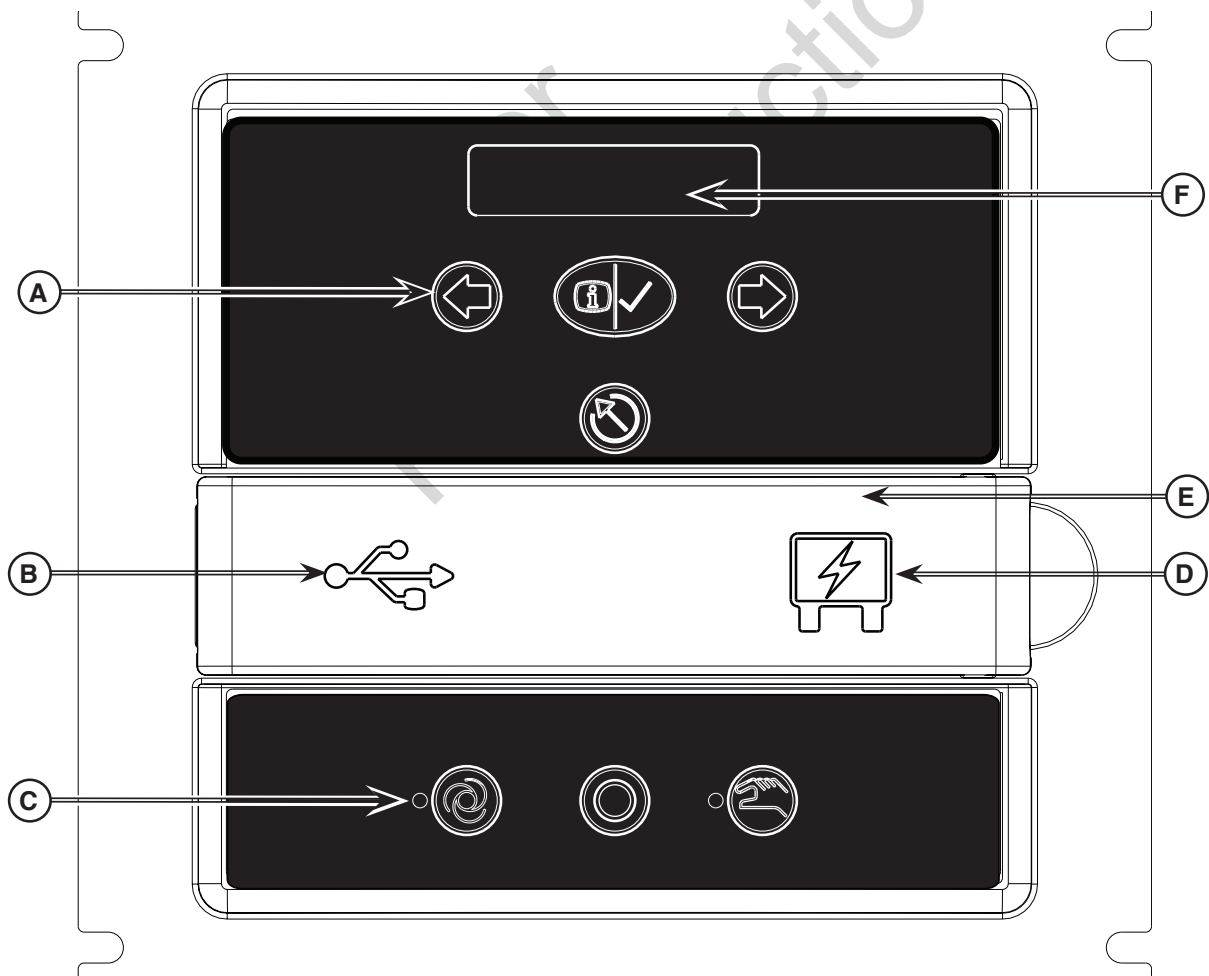









Figure 16 Control Panel

## INSTALLATION cont.



### Menu

The following chart shows the icons for the buttons that control the system control panel.

	<b>MENU</b>	ENTERS THE MENU (VIEW SETTINGS). PRESS TO CONFIRM SELECTION WHEN PROGRAMMING.
	<b>ESCAPE (EXIT)</b>	RETURNS TO LAST MENU ITEM.
	<b>RIGHT ARROW</b>	TOGGLES THROUGH MENU OPTIONS. SETS SYSTEM PARAMETERS.
	<b>LEFT ARROW</b>	TOGGLES THROUGH MENU OPTIONS. SETS SYSTEM PARAMETERS.
	<b>MANUAL MODE</b>	MANUALLY STARTS THE GENERATOR. PRESS AND HOLD BUTTON TO START THE GENERATOR.
	<b>OFF</b>	TURNS OFF RUNNING GENERATOR, PREVENTS GENERATOR FROM STARTING, AND RESETS ANY DETECTED FAULTS.
	<b>AUTOMATIC MODE</b>	NORMAL OPERATING POSITION. PRESS AND HOLD BUTTON TO PUT GENERATOR INTO AUTOMATIC MODE. IF A UTILITY POWER OUTAGE IS SENSED, THE SYSTEM WILL START THE GENERATOR. WHEN UTILITY POWER IS RESTORED, AUTO LETS THE ENGINE STABILIZE INTERNAL TEMPERATURES, SHUTS OFF THE GENERATOR, AND WAITS FOR THE NEXT UTILITY POWER OUTAGE.

**Figure 17** Control Panel Icons

The following chart describes key sequences for accessing different programming modes;

	<b>GENERAL SET-UP</b>	PRESS AND HOLD [ <b>LEFT ARROW AND RIGHT ARROW</b> ] FOR THREE SECONDS TO ENTER THE PROGRAM MODE.
	<b>ADVANCED SETTINGS</b>	PRESS AND HOLD [ <b>LEFT ARROW AND RIGHT ARROW AND ESC</b> ] FOR THREE SECONDS TO ENTER THE ADVANCED SETTINGS MODE.
	<b>WIRELESS LINK MODE</b>	PRESS AND HOLD [ <b>MENU AND ESC</b> ] FOR THREE SECONDS TO ENTER THE WIRELESS LINKING MODE (WHERE AVAILABLE).

**Figure 18** Control Panel Sequences

**NOTICE**  
Link Mode will time out in 5 minutes

# INSTALLATION cont.

## General Set Up Screen

For general set up, press and hold the left arrow and right arrow   for 3 seconds. Follow the prompts as outlined below.

**NOTE:** Date and Time were set at the factory and stored in the control panel memory. The Exercise Cycle was also set at the factory for Tuesdays, at 2:00 P.M. To update or change these settings, follow the steps below.

**NOTICE**  
Control panel will automatically reset during programming, if no buttons are pressed for 30 seconds.

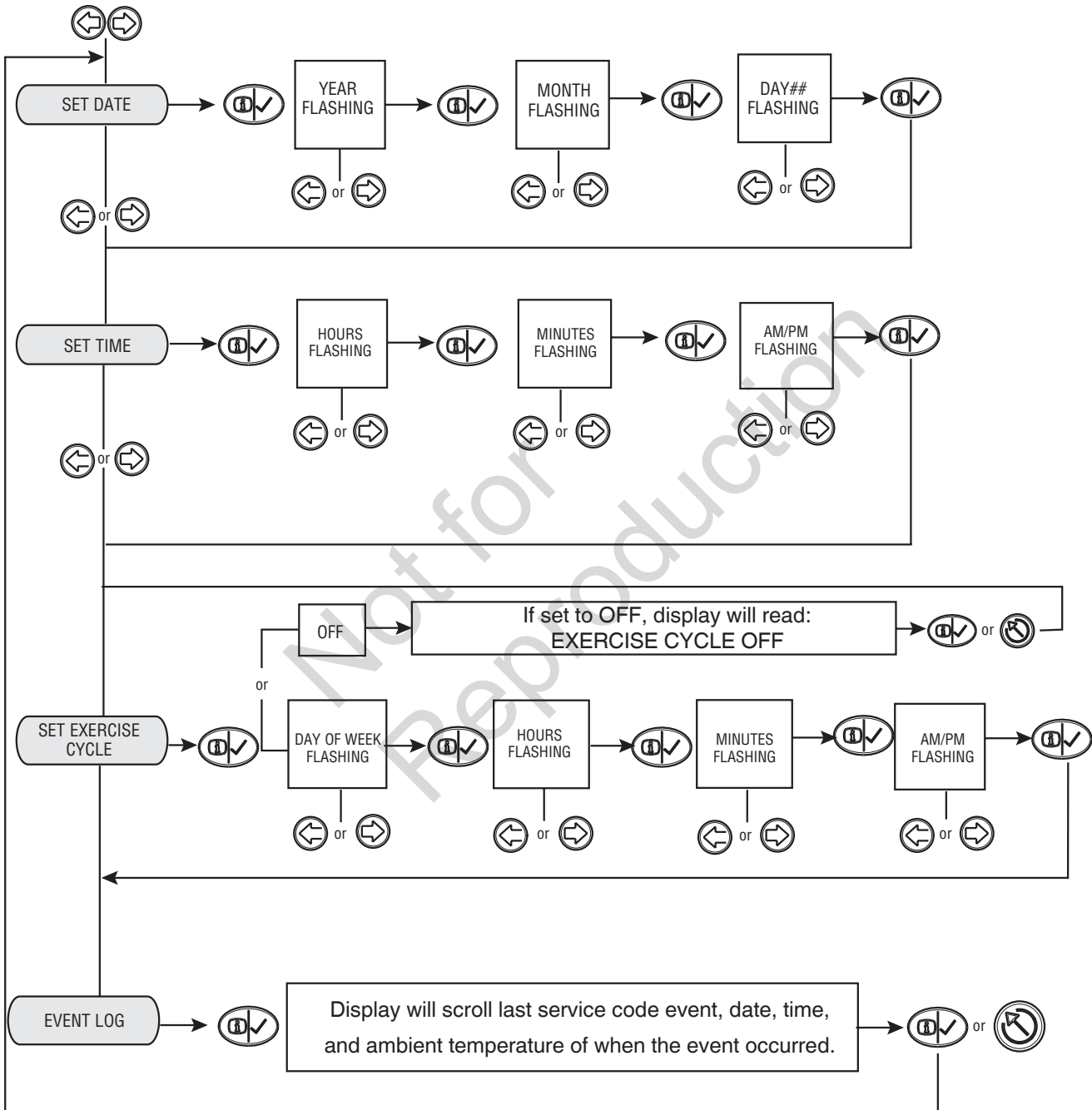

Figure 19 General Set Up Screen

Control Panel Prompts

**Automatic Mode**

In Automatic Mode, the display screen will display via scrolling text:

- **GENERATOR READY** - if the generator is in standby and utility power is present.
- **GENERATOR ON** - if the generator is running and utility power is not present.
- **SERVICE CODE** - if a system fault has been detected.

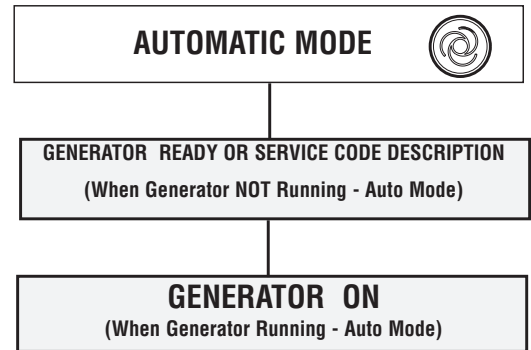

Figure 20 Control Panel Prompts

**General System Parameters**

To view general system parameters, press the **MENU** button.

The following will scroll across the digital display and then move to the next item:

- Run time
- Date
- Time
- Exercise Cycle date and start time

Press the **LEFT ARROW** or **RIGHT ARROW** at any time to move to the next item.

Press **ESCAPE** to go back to **GENERATOR READY**.

The control board will reset to **GENERATOR READY** if no user inputs are made for 10 seconds after all the items have been displayed.

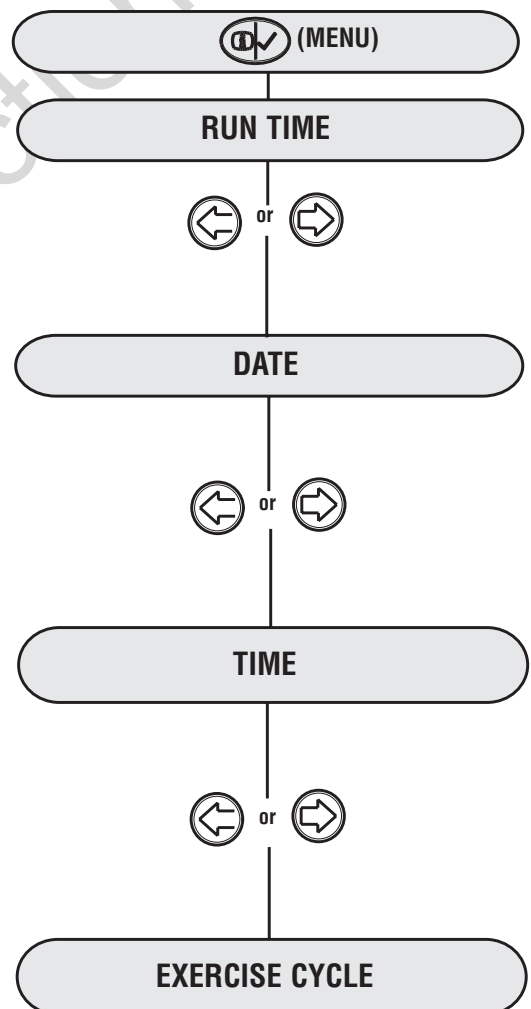





Figure 21 General System Parameters

## INSTALLATION cont.

### Advanced Settings Screen

Advanced setting parameters are preset at the factory for a typical installation. To view Advanced Settings items and/or to change items, follow the instructions listed below.

**Advanced settings are critical to the operation of the generator. Careful consideration should be taken when working in the Advanced Settings menu. Exercise caution when selecting and verifying parameters for the generator and region where the generator is being operated. Confirm all settings before operating the generator for the first time.**

For advanced menu items, press and hold the left arrow, right arrow, and escape key    for 3 seconds. Follow the prompts as outlined below.

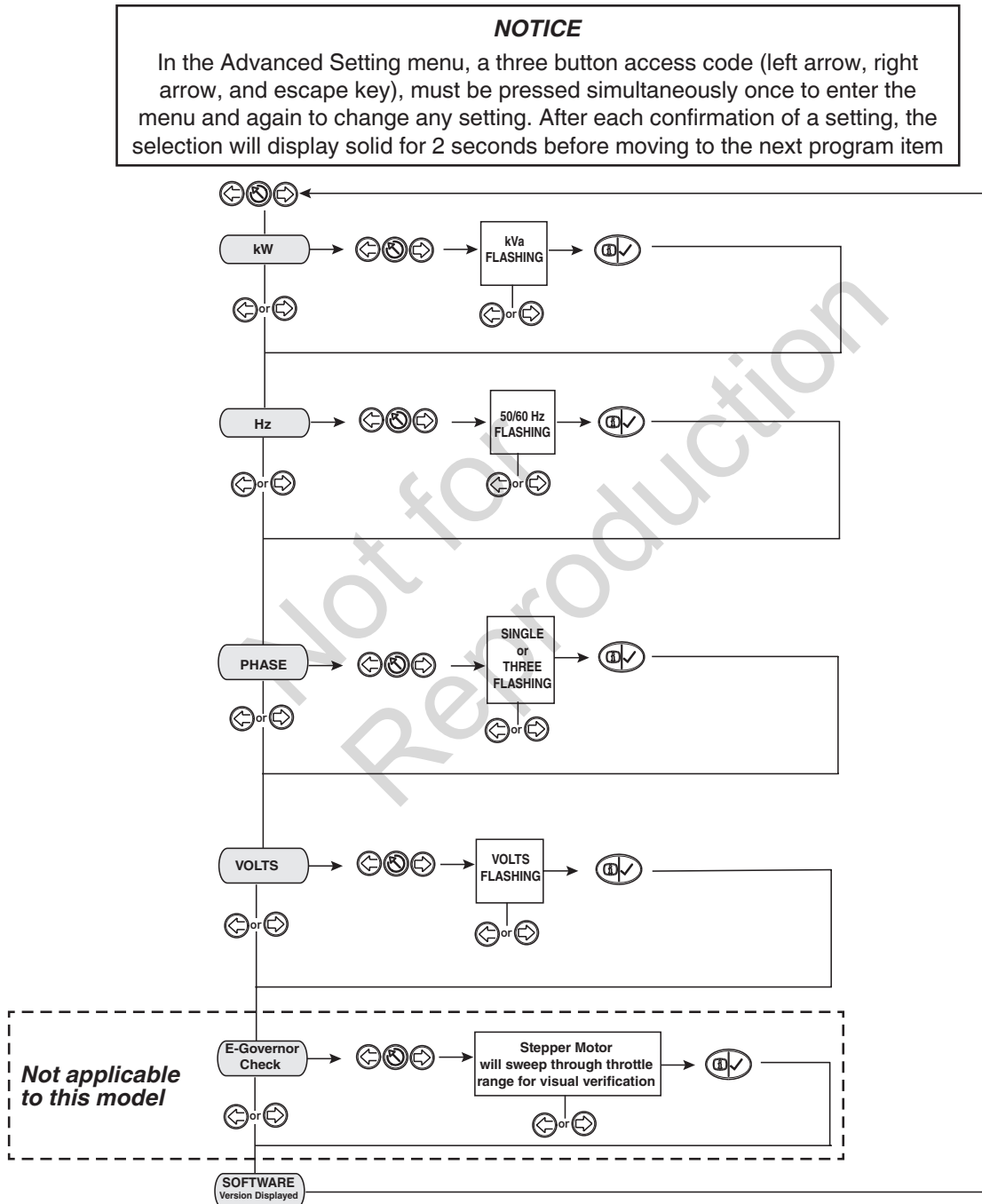

Figure 22 Advanced Settings Screen

## INSTALLATION cont.

### Service Code Detection System

The generator may have to run for long periods of time with no operator present. For this reason, the system is equipped with sensors that automatically shut down the generator in the event of potentially damaging conditions, such as low oil pressure, high temperature, over speed, and other conditions. Refer to **Service Code Detection System** in the Operator's Manual for more detailed information.

### Final Installation Considerations

### Engine Oil

#### NOTICE

Any attempt to crank or start the engine before it has been properly serviced with the recommended oil will result in equipment failure

Damage to equipment resulting from failure to follow this instruction will void engine and generator warranty.

The engine is shipped from the factory pre-run and filled with synthetic oil (API SJ/CF 5W-30). This allows for system operation in a wide range of temperature and climate conditions. Check oil level before starting engine.

The use of synthetic oil does not alter the required oil change intervals described in Operator's Manual.

For operation of temperatures below -1°C, the use of fully synthetic oil (minimum API SJ) of viscosity 5W/30 is required.

### Battery

The installer must supply and install a rechargeable starting battery. The starting battery **MUST** conform to the specifications shown below in the chart.

Battery Specifications	Standard	Cold Weather (less than -1°C)
Volts	12 Volt DC	12 Volt DC
Amps(MIN)	540 CCA (cold cranking amps)	800 CCA (cold cranking amps)
Construction	Wet lead acid	Wet lead acid
Terminal Type	Top post battery	Top post battery
Dimensions (MAX):(LxWxH)	BCI-26R 205mm x 175mm x 200mm	BCI-24F 280mm x 175mm x 225mm



### WARNING



Storage batteries give off explosive hydrogen gas during recharging. The slightest spark will ignite hydrogen and cause explosion, resulting in death or serious injury. Battery electrolyte fluid contains acid and is extremely caustic. Contact with battery contents could cause severe chemical burns. A battery presents a risk of electrical shock and high short circuit current. Before installing and/or servicing battery:

#### DO

- **Do** use tools with insulated handles.
- **Do** wear PPE (Personal Protective Equipment) of protective goggles, rubber apron, rubber boots and rubber gloves.
- **Do** remove all metal objects, such as jewelry, watches or rings.
- **Do** recycle battery through your local recycling company.

#### DO NOT

- **Do not** dispose of battery in a fire.
- **Do not** allow an open flame, spark, heat, or lit cigarette in vicinity during and for several minutes after servicing a battery.
- **Do not** open or mutilate battery.

## INSTALLATION cont.

### Initial Start-Up (No Load)

The generator has been configured for NG operation at the factory.

Fuel conversion, if needed, must be completed prior to performing these steps. See **Fuel Conversion**.

Before operating the generator or placing it into service, inspect the entire installation carefully. Then begin testing the system without any electrical loads connected, as follows:

1. Remove two screws (**A**) that secure control box cover to enclosure. Remove control box cover to expose generator's circuit breaker.
2. Connect an accurate frequency meter to line side of generator's main circuit breaker.
3. Set generator's main circuit breaker to **ON** (closed) position.
4. Verify manual shutoff valve is open.
5. Install 15A fuse in control board.
6. Press and hold **MANUAL** button on control board for 3 seconds. Engine will start.
7. Listen for unusual noises, vibration or other indications of abnormal operation. Check for oil leaks while engine runs.
8. Let engine warm up for 5 minutes to allow internal temperatures to stabilize.
9. Check generator output at load side of circuit breaker. Voltage should be 215 - 240 Volts, frequency should be 49.0 - 51.0 Hz.
10. Push and hold **OFF** button on control board until engine stops.
11. Reinstall control box cover.

### NOTICE

It may take a few minutes to purge the gaseous fuel lines when the generator is started for the first time

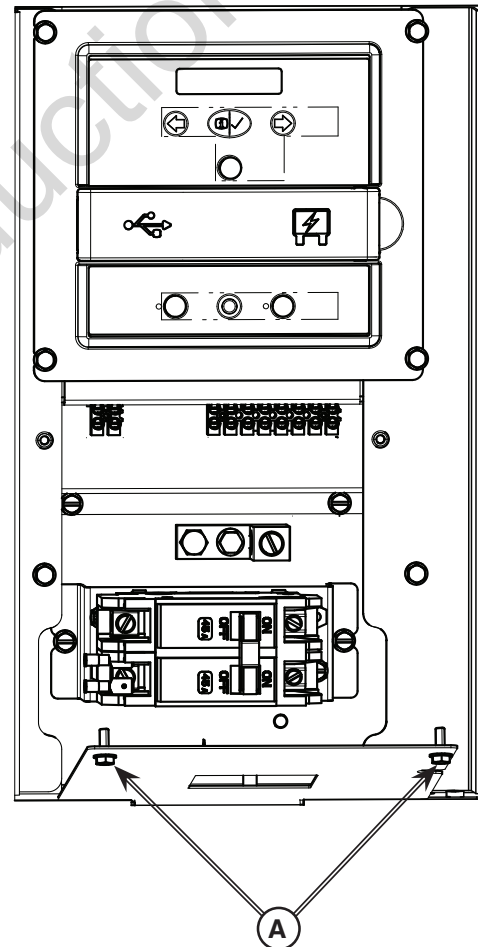



Figure 23 Control Box Cover



## OPERATION

### Automatic Operation Sequence

The generator's control board constantly monitors utility voltage. Should utility voltage drop below a preset level, the control board signals the engine to crank and start. When the utility voltage is restored above a preset voltage level, the engine is signaled to shut down. The system operation is not adjustable and is sequenced by sensors and timers on the control board as follows:

**CAUTION**



Auto start of Machinery - Installing the 15 Amp fuse could cause the engine to crank and start at any time without warning resulting in minor to moderate injury. Before installing and/or servicing generator:

**DO**

- **Do** observe that the 15A fuse has been removed from the control panel for shipping.
- **Do** remove the 15A fuse before maintaining and/or servicing generator.
- **Do** always press and hold the control board OFF button to prevent sudden start of generator when maintaining and/or servicing.

**DO NOT**

- **Do not** install 15A fuse until all plumbing and wiring has been completed when installing generator.
- **Do not** reinstall 15A fuse until all maintenance and/or service is complete on generator.

### Utility Voltage Dropout Sensor

- This sensor monitors utility source voltage
- If utility source voltage drops below about 70% of the nominal supply voltage, the sensor energizes a 3 second timer. The timer is used to sense low voltage conditions.
- Once the time has expired, the engine will crank and start.

### Engine Cool-Down Timer

When utility power is sensed and the load transfers to the utility source, the engine will go into a cool down period as described below:

- If the generator has run for MORE than 5 minutes, once the utility transfer occurs, the engine will continue to run for 1 minute before shutting down.
- If the generator has run for LESS than 5 minutes, once the utility transfer occurs, the engine will continue to run for 5 minutes before shutting down.

### Setting Local Date and Time

For setting local date and time, press and hold the left arrow and right arrow, simultaneously for 3 seconds. Follow prompts shown in **General Set Up Screen**.

### Setting Exercise Timer

The generator is equipped with an exercise timer. During the exercise period, the generator runs for 20 minutes and then shuts down. Electrical load transfer DOES NOT occur during the exercise cycle (unless an utility power outage occurs).

#### **NOTICE**

During weekly exercise cycle, the generator will run for 20 minutes, but will not supply power to home. During exercise cycle, the green LED READY light will blink

#### **NOTICE**

To turn off the generator exercise cycle, go to the **OFF** selection within the day of the week menu and press OK. The display will then scroll: EXERCISE CYCLE OFF

#### **NOTICE**

The generator is set to run the exercise cycle on Tuesday at 2:00 P.M.

To set or change exercise timer:

1. Press and hold the left arrow and right arrow simultaneously for 3 seconds to enter the General Set-Up flow chart in Menu section.
2. Verify and/or set the time and date on the generator.
3. Go to the SET EXERCISE prompt and hit the "OK" button. Refer to **General Set Up Screen**.

**SELECT DAY:** Use the left or right arrow to toggle through the days of the week. Once the day is selected, hit the "OK" button.

**SELECT HOUR:** Use the left or right arrow to toggle through 1 and 12 hours. Once the hour is selected, hit the "OK" button.

**SELECT MINUTE:** Use the left or right arrow to toggle between :00 and :59 minutes. Once the minute is selected, hit the "OK" button.

**SELECT AM/PM:** Use the left or right arrow to toggle between AM or PM. Once AM or PM is selected, hit the "OK" button.

**Read the User's Instructions and Troubleshooting Instructions for details on operation, maintenance and troubleshooting.**

**Read the illustrated parts list for service parts.**

## EQUIPMENT SPECIFICATIONS

---

### GENERATOR SPECIFICATIONS

Rated Power	8kVA
Rated Maximum Load Current (at 25°C LP)* at 230 Volts	34.8 Amps
Rated AC Voltage	230 Volts
Phase	Single Phase
Rated Frequency	50 Hertz
Generator Breaker	40 Amp
Normal Operating Range	-28.8°C to 40°C
Output Sound Power	97 dB(A) L <sub>WA</sub>
Shipping Weight	139 kg

\*Natural gas rating will depend on specific fuel but typical derates are between 10 to 20% off the LP gas rating.

### ENGINE SPECIFICATIONS

Displacement	570 cc
Bore	72 mm
Stroke	70 mm
Spark Plug Gap	0.51 mm
Spark Plug Torque	20 Nm
Armature Air Gap	0.20 - 0.30 mm
Intake Valve Clearance	0.10 - 0.15 mm
Exhaust Valve Clearance	0.18 - 0.23 mm
Oil Type	5W30 Synthetic
Oil Capacity	1.4 L
Engine End Cover Bolt Torque	25 Nm

### COMMON SERVICE PARTS

Air Filter	841359
Oil - 5W30 Synthetic	100074
Oil Filter	491056
Resistor Spark Plug	491055
Long Life Platinum Spark Plug	5066
Maintenance Kit	6035
Cold Start Kit	6030A
Fuse - ATO Type 15A	198573GS

Read the illustrated parts list for service parts.

# SCHEMATIC DIAGRAM

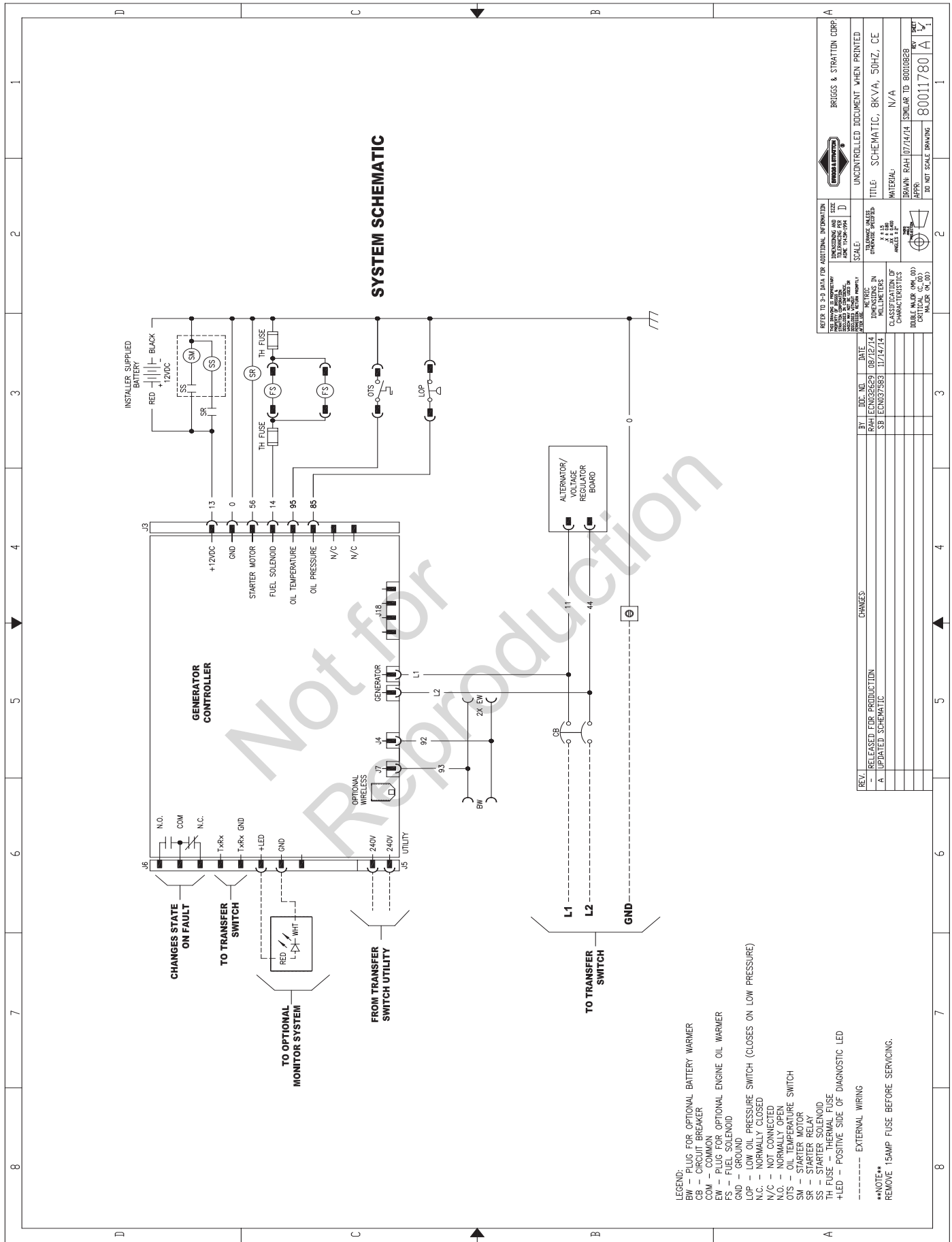

*Page intentionally left blank*

Not for  
Reproduction