

Dobot Magician Lite

User Guide

Issue: V1.9.1

Date: 2020-04-14

Copyright © ShenZhen Yuejiang Technology Co., Ltd 2021. All rights reserved.

No part of this document may be reproduced or transmitted in any form or by any means without prior written consent of Yuejiang Technology Co., Ltd

Disclaimer

To the maximum extent permitted by applicable law, the products described (including its hardware, software and firmware, etc.) in this document are provided **AS IS**, which may have flaws, errors or faults. Yuejiang makes no warranties of any kind, express or implied, including but not limited to, merchantability, satisfaction of quality, fitness for a particular purpose and non-infringement of third party rights. In no event will Yuejiang be liable for any special, incidental, consequential or indirect damages resulting from the use of our products and documents.

Before using our product, please thoroughly read and understand the contents of this document and related technical documents that are published online, to ensure that the robotic arm is used on the premise of fully understanding the robotic arm and related knowledge. Please use this document with technical guidance from professionals. Even if follow this document or any other related instructions, Damages or losses will be happen in the using process, Dobot shall not be considered as a guarantee regarding to all security information contained in this document.

The user has the responsibility to make sure following the relevant practical laws and regulations of the country, in order that there is no significant danger in the use of the robotic arm.

Shenzhen Yuejiang Technology Co., Ltd

Address: Floor 9-10, Building 2, Chongwen Garden, Nanshan iPark, Liuxian Blvd, Nanshan District, Shenzhen, Guangdong Province, China

Website: www.dobot.cc

Preface

Purpose

This Document describes the functions, technical specifications, installation guide and system commissioning of Magician Lite, making it easy for users to fully understand and use it.

Intended Audience

This document is intended for:





- Customer Engineer
- Sales Engineer
- Installation and Commissioning Engineer
- Technical Support Engineer

Change History

Date	Change Description
2020/01/11	The first release
2020/04/14	Add power box security

Symbol Convention

The symbols that may be founded in this document are defined as follows.

Symbol	Description
 DANGER	Indicates a hazard with a high level of risk which, if not avoided, could result in death or serious injury
 WARNING	Indicates a hazard with a medium level or low level of risk which, if not avoided, could result in minor or moderate injury, robotic arm damage
 NOTICE	Indicates a potentially hazardous situation which, if not avoided, can result in robotic arm damage, data loss, or unanticipated result
 NOTE	Provides additional information to emphasize or supplement important points in the main text

Contents

1. Security Precautions	1
1.1 General Security.....	1
1.2 Power Box Security	2
1.3 Precautions.....	2
2. Quick Start	4
2.1 Connecting Cables to Magician Lite.....	4
2.2 Installing the DobotStudio	7
2.2.1 System Requirements	7
2.2.2 Obtaining the DobotStudio Package.....	7
2.2.3 Installing the DobotStudio.....	7
2.2.4 Verifying the Installation	9
2.3 Powering On/Off Magician Lite	10
2.4 Getting Started	11
3. Introduction.....	17
3.1 Overview.....	17
3.2 Appearance and Constitute	17
3.3 Working Principle	18
3.3.1 Workspace	18
3.3.2 Coordinate System.....	19
3.3.3 Motion Mode.....	20
3.4 Technical Specifications	23
3.4.1 Technical Parameters.....	23
3.4.2 Sizes.....	25
4. Interface Description	26
4.1 Magician Lite Interface Description	26
4.2 Magic Box Interface Description.....	27
4.3 Power Box Interface	27
4.4 Multiplexed I/O Interface Description	28
5. Operation.....	34
5.1 Introduction to the DobotStudio	34
5.1.1 Function Modules.....	34
5.1.2 Common Areas of DobotStudio Page.....	35
5.2 Homing	37
5.3 Performing Teaching & Playback Tasks	38
5.3.1 Installing a Suction Cup Kit	38
5.3.2 Installing a Gripper Kit.....	40
5.3.3 Teaching & Playback Page.....	41
5.3.4 ARC Motion Mode.....	44
5.3.5 Teaching & Playback Example.....	47
5.4 Working in Offline Mode.....	52
5.5 Writing and Drawing	54
5.5.1 Installing a Writing and drawing kit	54

5.5.2	Connecting the DobotStudio	56
5.5.3	Importing Image Files and Setting Writing Parameters.....	57
5.5.4	Adjust the Position of the Pen Nib	62
5.6	Operating Blockly.....	65
5.7	Scripting.....	66

1. Security Precautions

This topic describes the security precautions that should be noticed when using this product. Please read this document carefully before using the robotic arm for the first time. This product needs to be carried out in an environment meeting design specifications, you cannot remold the product without authorization, otherwise, it could lead to product failure, and even personal injury, electric shock, fire, etc. The installation personnel, operators, teaching personnel, and programmers must read this document carefully and use the robotic arm strictly according to the regulations of this document strictly.

1.1 General Security



The robotic arm is electrical equipment. Non-professional technicians cannot modify the wire, otherwise, it is vulnerable to injury the device or the person.

The following security rules should be followed when using the robotic arm.

- You should comply with local laws and regulations when operating the robotic arm. The security precautions in this document are only supplemental to local laws and regulations.
- The **DANGER**, **WARNING**, and **NOTICE** marks in this document are only supplemental to the security precautions.
- Please use the robotic arm in the specified environment scope. If not, exceeding the specifications and load conditions will shorten the service life of the product even damage the equipment.
- Before operating and maintaining the robotic arm, the personnel responsible for the installation, operation, and maintenance must be trained to understand the various security precautions and to master the correct methods of operation and maintenance.
- Highly corrosive cleaning is not suited to cleaning the robotic arm. The anodized components are not suitable for immersion cleaning.
- People cannot repair and disassemble the robotic arm without professional training. If there is a problem with the robotic arm, please contact Dobot technical support engineer in time.
- Please comply with the relevant laws to deal with the product which is scrapped, and protect the environment.
- There are small parts in the packing box, Please keep them away from children, to avoid any accidents.
- DO NOT let children play with the robotic arm alone. All processes need to be monitored while running. After processes have finished, please turn off the equipment promptly.
- DO NOT put hands into the workspace of the robotic arm while running, to avoid bruising or pinching.
- Be careful during the robotic arm carrying or installing. Please follow the instructions on the packing box to put down the robotic arm gently and place it correctly in direction of

the arrow.

- Commissioning of the incomplete machine is prohibited until it has been installed in a machine and the whole machine complies with the provisions of the Machinery Directive (2006/42/EC).
- It is prohibited to modify or remove the nameplates, instructions, icons, and marks on the robotic arm and the related equipment.
- Please refer to *Magician Lite Quick Start* along with the packing box before using it.

1.2 Power Box Security

The following basic precautions should be followed when using this product.

- Read all the instructions before using the product.
- To reduce the risk of injury, close supervision is necessary when the product is used near children.
- Do not put fingers or hands into the product.
- Do not expose power box to rain or snow.
- Use of a power supply or charger not recommended or sold by power pack manufacturer may result in a risk of fire or injury to persons.
- Do not use the power box in excess of its output rating. Overload outputs above rating may result in a risk of fire or injury to persons.
- Do not use the power box that is damaged or modified. Damaged or modified batteries may exhibit unpredictable behavior resulting in fire, explosion or risk of injury.
- Do not disassemble the power box. Take it to a qualified service person when service or repair is required. Incorrect reassembly may result in a risk of fire or injury to persons.
- Do not expose a power pack to fire or excessive temperature. Exposure to fire or temperature above 100 °C may cause explosion. The temperature of 100 °C can be replaced by the temperature of 212 °F.
- Have servicing performed by a qualified repair person using only identical replacement parts. This will ensure that the safety of the product is maintained.
- Switch off the power box when not in use.

1.3 Precautions

- Magician Lite was calibrated at the factory. By default, the coordinate of J1 axis is 0° after Magician Lite moving to the default homing point, i.e. The forearm is in the middle of the front of the base of Magician Lite.
- If the LED indicator turns red after starting up, it indicates that the Magician Lite is at a limited position. Please make the Magician Lite in the workspace.
- Magician Lite will move slowly to the specific position when shutdown. DO NOT put hands into the workspace of Magician Lite while running, to avoid bruising or pinching. Only once the LED indicator completely turns off, Magician Lite can be powered down.

- If the Magician Lite coordinate reading is abnormal during use, please press the forearm unlock button to correct the reading.
- Please turn off Magician Lite completely first before connecting or disconnecting external equipment, such as infrared sensor, color sensor, etc. Otherwise, it causes damage to your device.

2. Quick Start

This topic briefly describes how to operate the Magician Lite with the software DobotStudio, allowing you to quickly know and use Magician Lite. Figure 2.1 shows the process of getting started with Magician Lite.

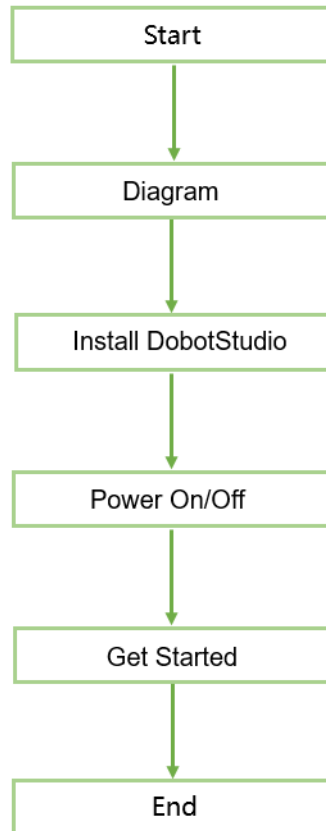

Figure 2.1 The process of getting started with Magician Lite

2.1 Connecting Cables to Magician Lite

- When not used with Magic Box, connect directly to Magician Lite.

Step 1 Connect Magician Lite to your computer with USB cable, as shown in Figure 2.2.



Figure 2.2 Connect Magician Lite to your computer

Step 2 Connect power adapter to power interface on Magician Lite, as shown in Figure 2.3.



Figure 2.3 Connect Magician Lite to the electrical outlet

- When used with Magic Box, connect Magic Box and Magician Lite.

Step 1 Connect Magician Lite and Magic Box with 4PIN power cable and 10PIN communication cable, 4Pin power cable is connected to **12V** power interface, 10Pin communication cable is connected to **Communication1** interface.



Figure 2.4 Connect Magician Lite and Magic Box

Step 2 Connect Magic Box and your computer with USB cable.



Figure 2.5 Connect Magician Lite to the electrical outlet

Step 3 Connect power adaptor to Magic Box.



Figure 2.6 Connect power adaptor

2.2 Installing the DobotStudio

You can control Magician Lite and Magic Box by DobotStudio (V1.9.1 and above) to implement functions such as Teaching & Playback, fully programmable applications. This topic introduces Teaching & Playback.

2.2.1 System Requirements

The DobotStudio supports the following Windows versions:

Windows 7, Windows 8, and Windows 10 (This manual is explained based on this version)

2.2.2 Obtaining the DobotStudio Package

Before using Magician Lite, download the Windows DobotStudio package from <https://www.dobot.cc/downloadcenter/dobot-magician-lite.html#most-download>.

2.2.3 Installing the DobotStudio

Prerequisites

The DobotStudio package has been obtained.

Procedure

Step 1 Unpack the DobotStudio package to a destination directory.

For example, this directory is *Installation Directory*\DobotStudio. You can install the DobotStudio to another location based on site requirements.

Step 2 In the installation directory double-click **DobotStudioSetup.exe**. The **Select Setup Language** dialog box is displayed, as shown in Figure 2.7.

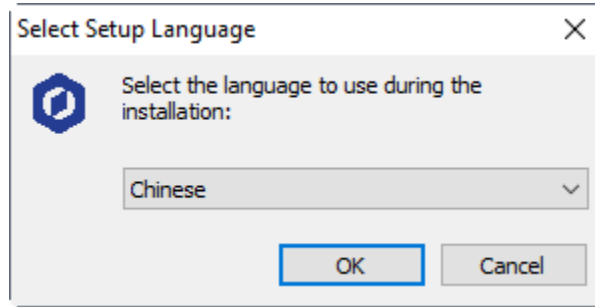

Figure 2.7 The Select Setup Language dialog box

- Step 4** Choose a setup language such as **English**, as shown in Figure 2.8. You can also select **Chinese** if needed.

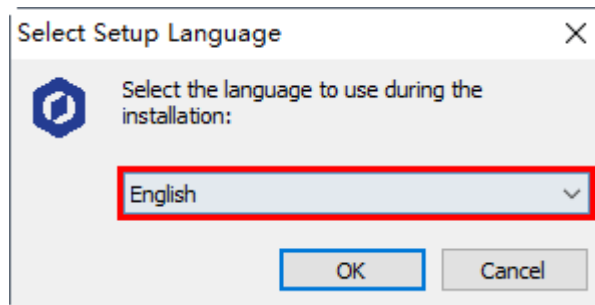

Figure 2.8 Select English

- Step 5** Click **OK** to follow the on-screen instructions to continue with the installation. During the installation, the Driver Installation dialog box is displayed, two drivers need to be installed, as shown in Figure 2.9.

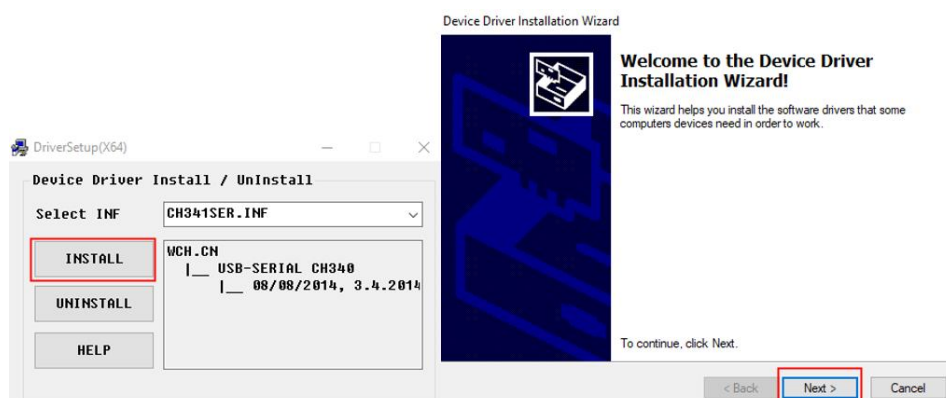

Figure 2.9 The Device Driver Installation Wizard dialog box

- Step 6** Click **Next** to install the first driver, and then click **INSTALL** to install the second driver.

When the drivers are installed successfully, the **Completing the Device Driver Installation Wizard** dialog box is displayed. Click **Finish**, as shown in Figure 2.10.

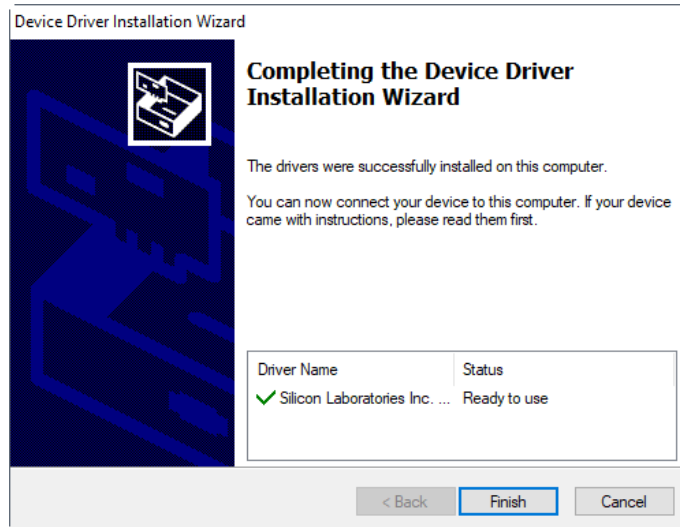

Figure 2.10 The Completing the Device Driver Installation Wizard dialog box

Step 7 Click **Next** to continue to install the DobotStudio by following the prompts on the **Setup – DobotStudio** dialog box.

When the installation is complete, the **Completing the DobotStudio Setup Wizard** dialog box is displayed. Click **Finish**, as shown in Figure 2.11.

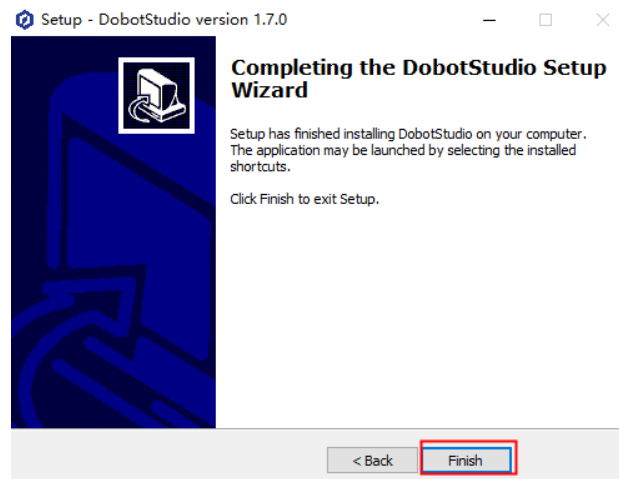

Figure 2.11 The Completing the DobotStudio Setup Wizard dialog box

2.2.4 Verifying the Installation

2.2.4.1 Verifying the DobotStudio

If the DobotStudio is launched and runs properly by double-clicking the desktop shortcut to this program, it means that it is installed successfully.

2.2.4.2 Verifying the Dobot Driver

If an available COM port is displayed on the upper left corner of the DobotStudio page after the robotic arm is powered on, as shown in Figure 2.12, the robotic arm driver is installed successfully.

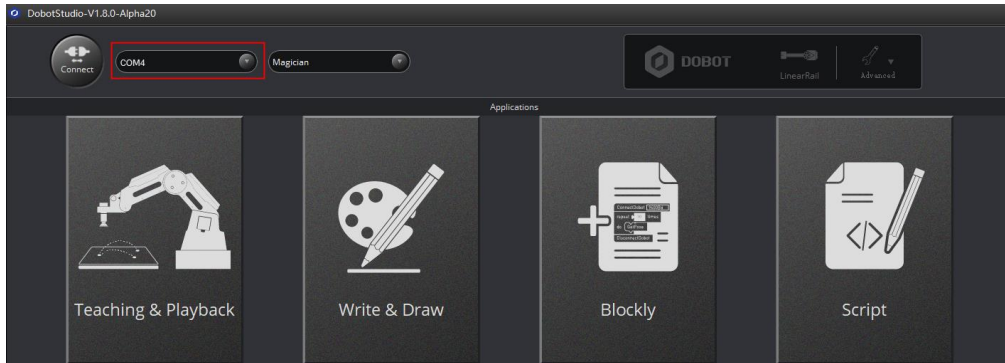

Figure 2.12 An available COM port is displayed

If no COM port is available, check whether the robotic arm driver is successfully installed by following the steps below.

- Step 1** Connect Magician Lite to your computer with the supplied USB cable.
- Step 2** Press the power button to apply power.
- Step 3** Launch the **Device Manager** window to locate the **Ports (COM & LPT)** section. If the item **USB Serial Device (COM8)** is displayed, it means the robotic arm driver is installed successfully.

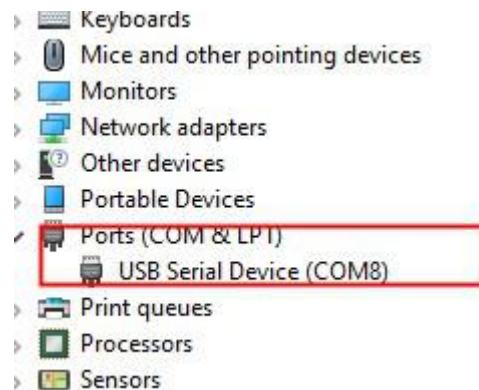

Figure 2.13 The robotic arm driver in the Device Manager window

2.3 Powering On/Off Magician Lite

- **Power on:** Press power button on Magician Lite or Magic Box, as shown in Figure 2.14. Once Magician Lite is powered on, all the stepper motors lock, and a short beep sound will be heard, the LED indicator turns green. Now Magician Lite is ready to use.



Figure 2.14 Power on Magician Lite

⚠ NOTICE

If the LED indicator is red after powering on Magician Lite, it means that Magician Lite reaches its limited position. To go back to the workspace, press and hold the unlock button on the Forearm to move Magician Lite to another desired position. After releasing the button the LED indicator turns green.

- **Power off:** When the LED indicator is green, press the power button to turn off Magician Lite. In this case, the Forearm moves slowly to the Rear Arm while the angle between them becomes small. Finally, the two arms reach a specific position.

⚠ WARNING

Watch your hand during the shutdown process.

2.4 Getting Started

This topic describes how to use Magician Lite to complete the teaching & playback function by saving three points in the MOVJ mode, allowing you to get the basic knowledge of the usage of the robotic arm.

Prerequisites

- The DobotStudio has been installed. For details, please refer to 2.2 *Installing the DobotStudio*.
- Magician Lite is powered on. For details, please refer to 2.3 *Powering On/Off Magician Lite*.

Procedure

Step 1 Double-click the desktop shortcut of the DobotStudio.

The DobotStudio page is displayed as shown in Figure 2.15.

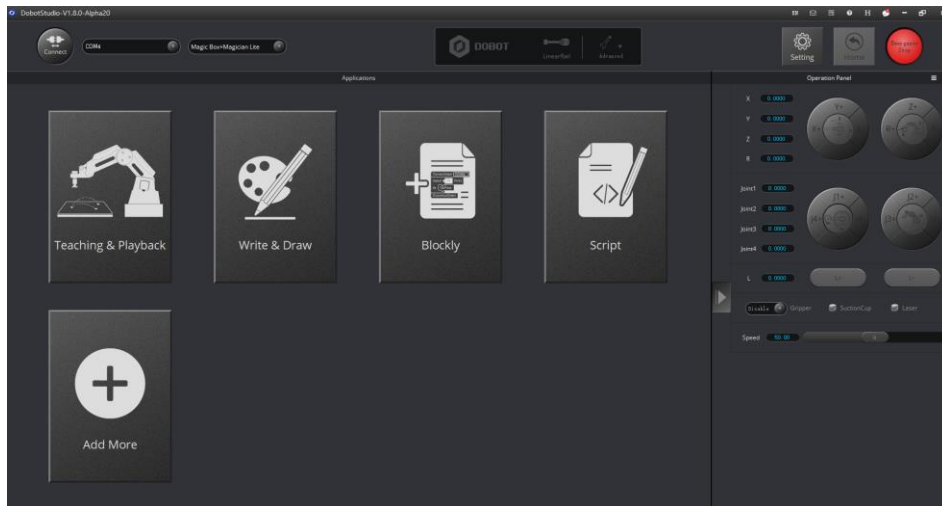

Figure 2.15 The DobotStudio page

Step 2 Click **Connect** on the DobotStudio page, as shown in Figure 2.16. Select **Magician Lite** in device type box (if using Magic Box, you need to select **Magic Box+Magician Lite**) and click **Connect**.

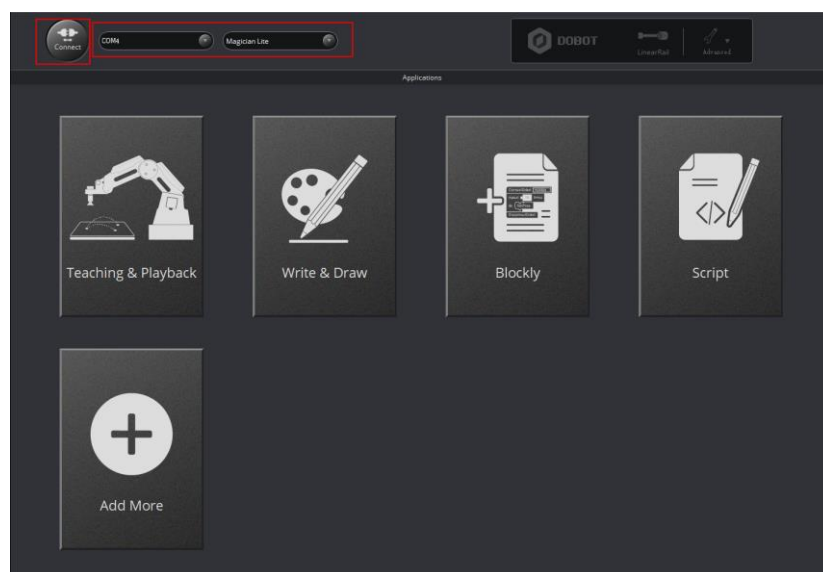

Figure 2.16 Click Connect

Step 3 Use DobotStudio to accomplish a teaching & playback task.

1. Click **Teaching & Playback**, as shown in Figure 2.17.

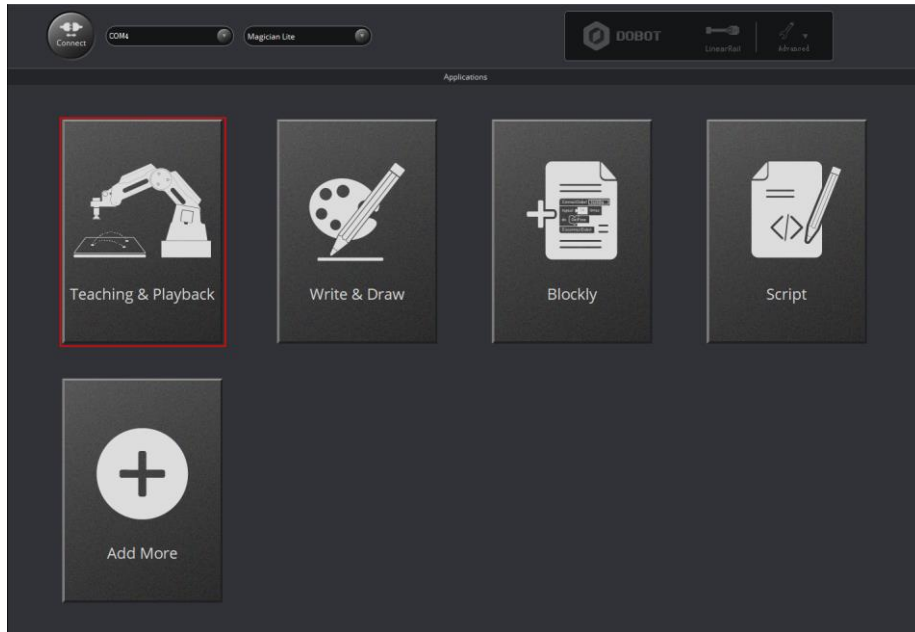

Figure 2.17 Click Teaching & Playback

2. Select **PTP Point > MOVJ** mode in the Save Point area, as shown in Figure 2.18.

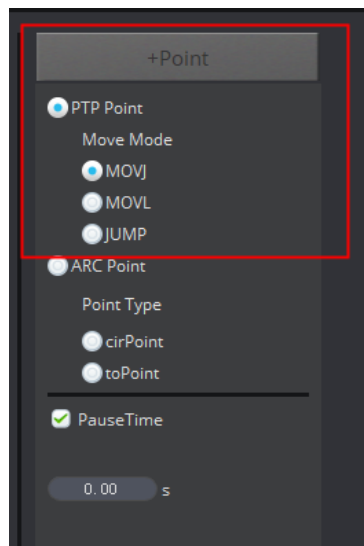

Figure 2.18 Select MOVJ motion mode

3. Press and hold the unlock button on the Forearm to move the robotic arm to a

position such as a point A, and then release the button.

In this case, the DobotStudio will save the Cartesian coordinate of point A, as shown in Figure 2.19.

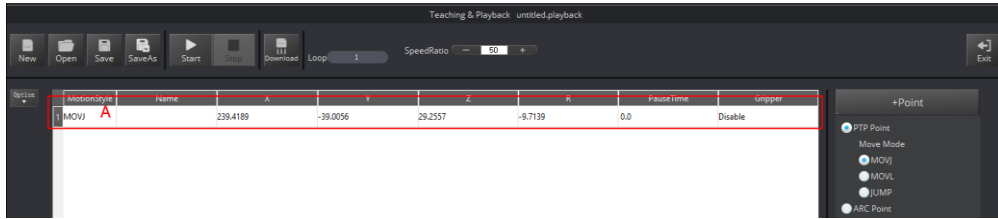

Figure 2.19 The Cartesian coordinate of the point A

NOTE:

Apart from hand-guided teaching, you can accomplish a teaching task by jogging Magician Lite in the Cartesian or Joint coordinate system, as shown in Figure 2.20.



Figure 2.20 Jog Magician Lite in the Cartesian or Joint coordinate system

4. Move the robotic arm to the other two locations such as points B and C by referring to the method of creating point A above, as shown in Figure 2.21. The robotic arm will save the Cartesian coordinates corresponding to these two points.

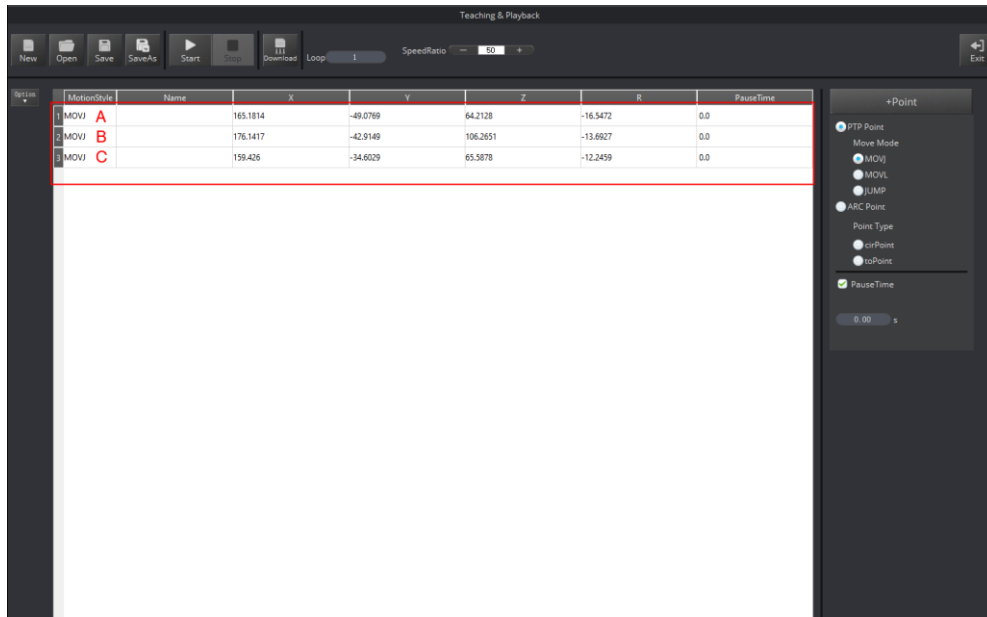

Figure 2.21 The Cartesian coordinates of points B and C

5. Enter **3** in the **Loop** text box.

The robotic arm will repeat the sequence of movements three times, as shown in Figure 2.22.

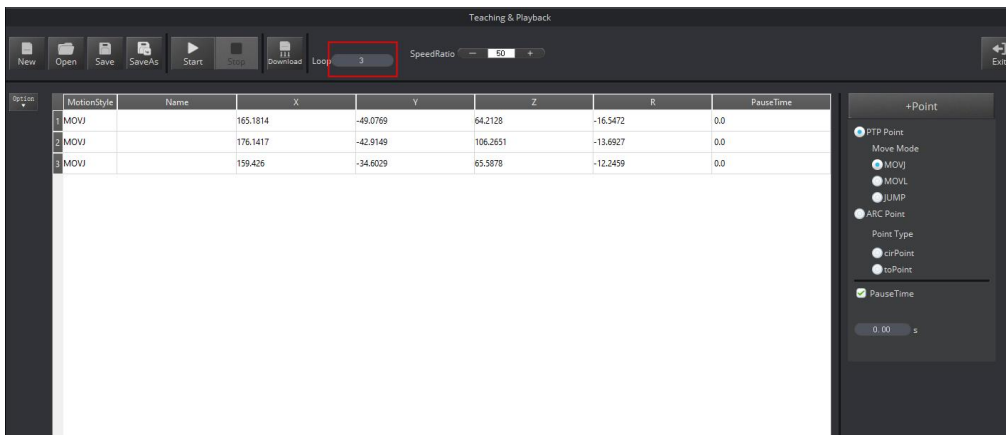

Figure 2.22 Enter 3 in the Loop text box

6. Click **Start** to perform the motions taught above, as shown in Figure 2.23.

The robotic arm will stop after playing back the steps for three times.

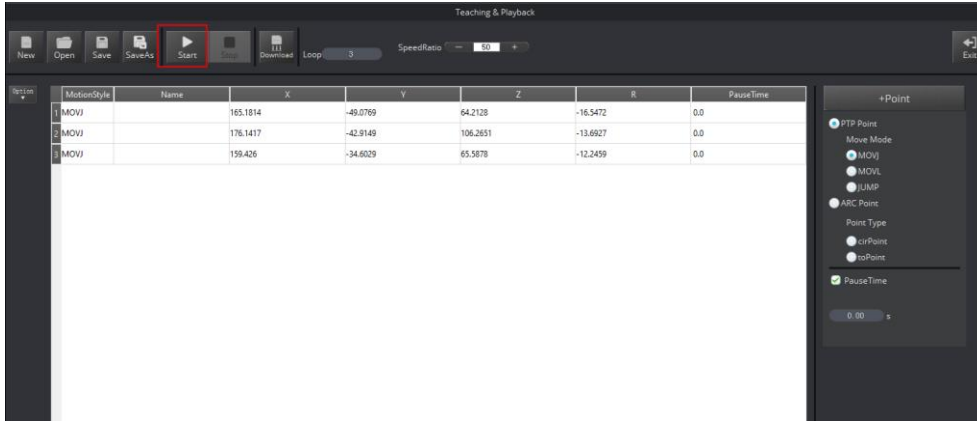

Figure 2.23 Click Start

7. Click  to exit the **Teaching & Playback** page, as shown in Figure 2.24.

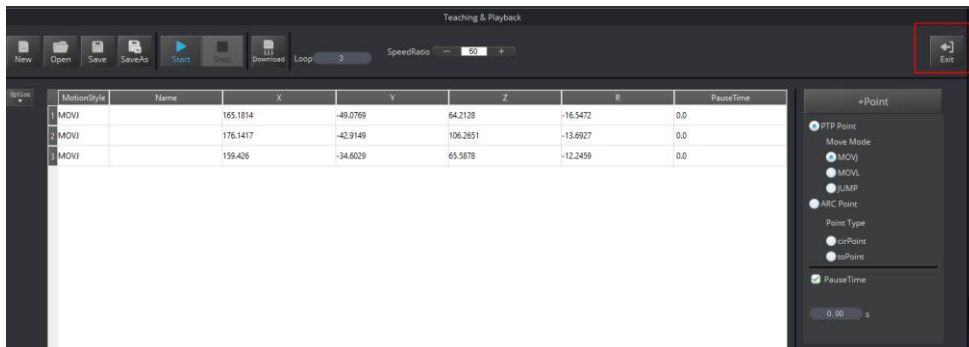

Figure 2.24 Click Exit

3. Introduction

3.1 Overview

Magician Lite is a multifunctional desktop robotic arm for practical training education, supporting teaching and playback, blockly graphics programming, script, etc. It also supports secondary development by various extensible I/O interfaces provided by Magic Box, which really makes your creativity and imagination increase without any limitation.

Magician Lite features an external controller called “Magic Box” that separates motion control algorithm and user tasks to allow more convenience for programming and creating. Magician Lite supports offline function, 2 controllable power interfaces with 12V, 2 multi-function communication interfaces, 6 universal IO interfaces, 2 stepper motor interfaces and several I2C interfaces are available. Users can expand a wide range of sensors and related accessories to achieve more possibilities.

Power Box is a separate power accessory, which contains 2 12V out interfaces to supply power for Magician Lite and Magic Box. it is also convenient to carry and operate.



Figure 3.1 The appearance of Magician Lite

3.2 Appearance and Constitue

Magician Lite consists of Base, Rear Arm, Forearm, and end-effector, etc. Figure 3.2 shows the appearance.

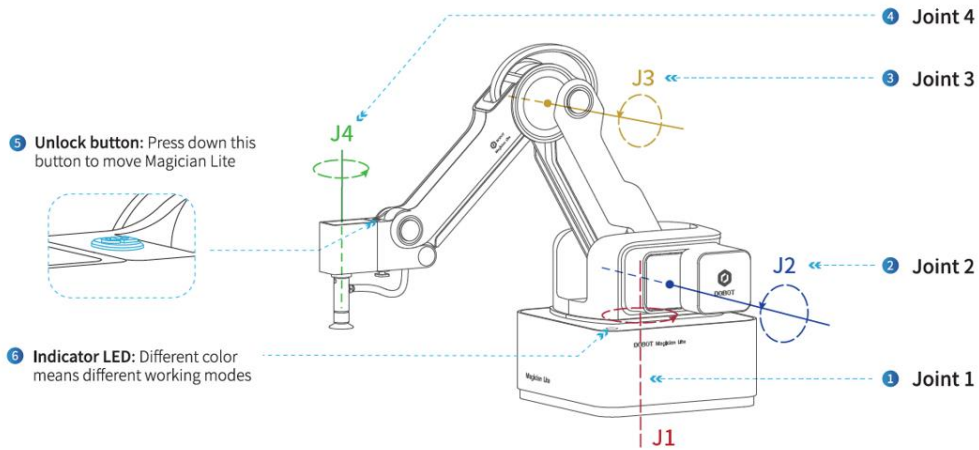

Figure 3.2 The appearance of Magician Lite

3.3 Working Principle

This topic describes the workspace, principle, size and technical specifications of Magician Lite.

3.3.1 Workspace

Figure 3.3 and Figure 3.4 shows the workspace.

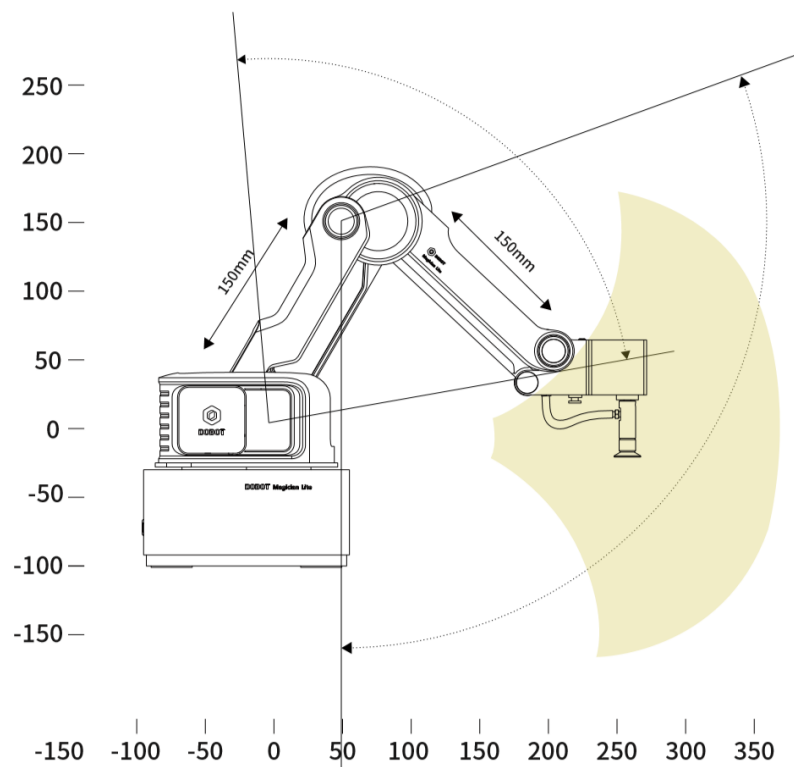

Figure 3.3 Workspace of Magician Lite (1)

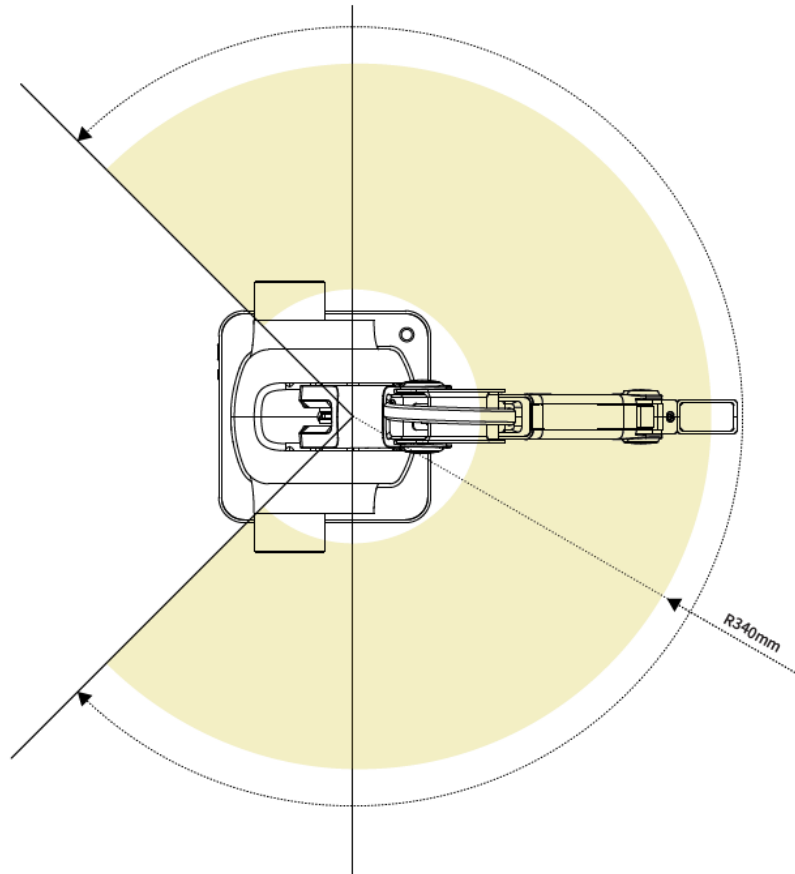

Figure 3.4 Workspace of Magician Lite (2)

3.3.2 Coordinate System

Magician Lite has two types of coordinate systems, the joint one and the Cartesian one, as shown in Figure 3.5 and Figure 3.6 respectively.

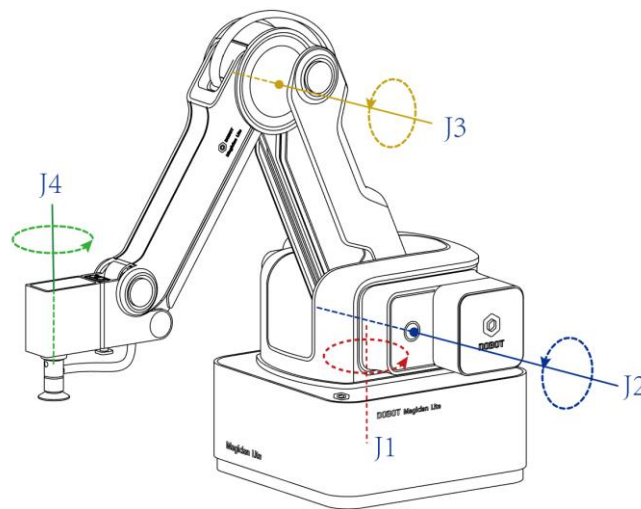

Figure 3.5 Joint coordinate system

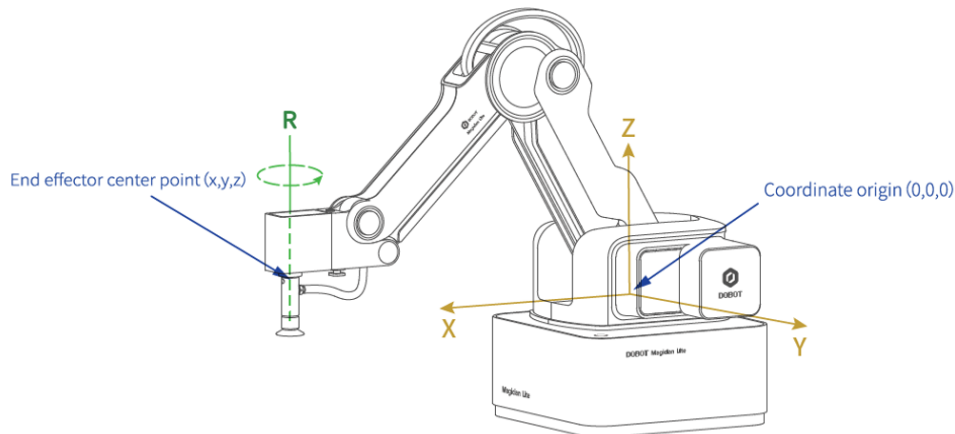

Figure 3.6 Cartesian coordinate system

- Joint coordinate system: The coordinates are determined by the motion joints.
 - If the end-effector with servo is installed, such as suction cup kit, gripper kit, Magician Lite contains four joints: J1, J2, J3, and J4, which are all the rotating joints. The positive direction of these joints is counter-clockwise.
- Cartesian coordinate system: The coordinates are determined by the base.
 - The origin is the center of the three motors (Rear Arm, Forearm, base).
 - The direction of the X-axis is perpendicular to the base forward.
 - The direction of the Y-axis is perpendicular to the base leftward.
 - The direction of the Z-axis is vertical upward, which is based on the right-hand rule.
 - The R-axis is the attitude of the servo center relative to the origin of the robotic arm, of which the positive direction is counter-clockwise. The R-axis only exists once the end-effector with servo is installed.

3.3.3 Motion Mode

The motion modes of Magician Lite include Jogging, Point to Point (PTP), ARC.

3.3.3.1 Jogging Mode

Jogging mode is the mode that jogging Magician Lite to a point in Cartesian coordinate system or Joint coordinate system when teaching.

NOTE

This topic describes jogging mode by the GUI operation of DobotStudio.

- Cartesian coordinate system mode
 - Click **X+**, **X-** and Magician Lite will move along X-axis in a negative or positive direction.
 - Click **Y+**, **Y-** and Magician Lite will move along Y-axis in a negative or positive direction.

direction.

- Click **Z+**, **Z-** and Magician Lite will move along Z-axis in a negative or positive direction.
- Click **R+**, **R-** and Magician Lite will rotate along R-axis in a positive or negative direction.

⚠ NOTICED

If the end-effector with servo is installed on the Magician Lite, the R-axis will move together with Y-axis, to make sure that the terminal posture relative to the origin stays constant.

- Joint coordinate system mode
 - Click **J1+**, **J1-** and control the base motor to rotate in the negative or positive direction.
 - Click **J2+**, **J2-** and control the Rear Arm motor to rotate in the negative or positive direction.
 - Click **J3+**, **J3-** and control the Forearm motor to rotate in the negative or positive direction.
 - Click **J4+**, **J4-** and control the servo to rotate in the negative or positive direction.

3.3.3.2 Point to Point (PTP)

PTP mode supports MOVJ, MOVL, and JUMP, which means point to point movement. The trajectory of playback depends on the motion mode.

- MOVJ: Joint movement. From point A to point B, each joint will run from an initial angle to its target angle, regardless of the trajectory, as shown in Figure 3.7.

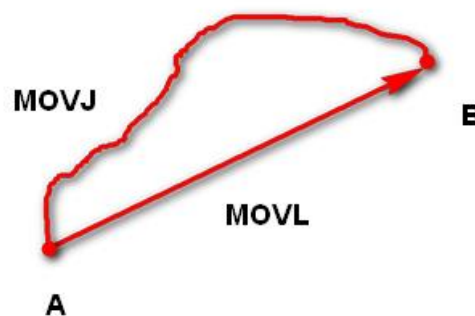

Figure 3.7 MOVL/MOVJ mode

- MOVL: Rectilinear movement. The joints will perform a straight line trajectory from point A to point B, as shown in Figure 3.7.
- JUMP: From point A to point B, the joints will move in MOVJ mode, of which the trajectory looks like a door, as shown in Figure 3.8.

1. Move up the lifting Height in MOVJ mode.

2. Move horizontally to a point that is above B by height.
3. Move down to point B.



Figure 3.8 JUMP mode

3.3.3.3 ARC

The trajectory of ARC mode is an arc, which is determined by three points (the current point, any point and the end point on the arc), as shown in Figure 3.9.

⚠ NOTICE

In ARC mode, it is necessary to confirm the three points with other motion modes, and the three points cannot be in a line.

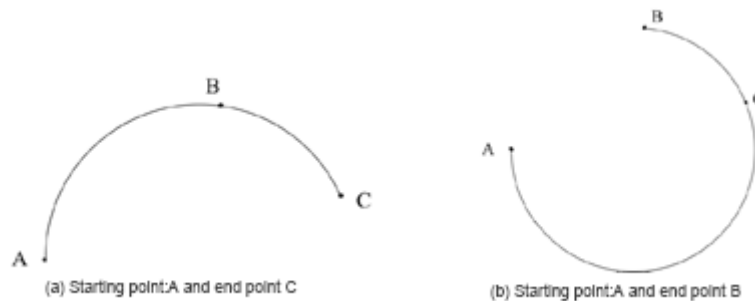

Figure 3.9 ARC mode

3.3.3.4 Application Scenarios

The application scenario depends on the trajectory in motion mode, as shown in Table 3.1.

Table 3.1 Application scenario

Motion mode	Application scenario
MOVL	If the trajectory of playback is required as a straight line, you can choose MOVL

Motion mode	Application scenario
MOVJ	If the trajectory of playback is not required but high speed is required, you can choose MOVJ
JUMP	If the movement of two points is required to lift upwards by amount of height, such as sucking up, grabbing, you can choose JUMP
ARC	If the trajectory of playback is required as an arc, such as dispensing, you can choose ARC

3.4 Technical Specifications

3.4.1 Technical Parameters

Table 3.2 Magician Lite technical parameters

Name	Magician Lite	
Maximum payload	250g	
Maximum reach	340mm	
Motion range	J1	-135 °~135 °
	J2	-5 °~80 °
	J3	-10 °~85 °
	J4	-145 °~145 °
Repeated positioning accuracy	±0.2 mm	
Power supply	100V~240V AC, 50/60Hz	
Power in	12V/5A DC	
Power	60W Max	
Communication	USB, 10PIN Communication Interface	
Software	DobotStudio/DobotScratch	
Working temperature	-5 °C~+45 °C	

Table 3.3 Magic Box technical parameters

Name	Magic Box
Control chip	ARM 32-bit Cortex-M4
Frequency	168 MHz

Power supply	100V~240V AC, 50/60Hz
Power in	12V/5A DC
Working Temperature	-5 °C - 45 °C
Capacity	60W Max
Communication mode	USB virtual serial/serial/Bluetooth
Program language	MicroPython
Software	DobotStudio/DobotScratch
Weight	98g
Size	95 mm×80 mm×21.5 mm
Power interface	4 PIN, 12V/3A DC
Multifunctional Communication Interface	10PIN, Serial port communication interface
General I/O expand interface	Green Port, 4PIN, 3.3V/5V-IO, 5V/1A-VCC, Multiplexing Interface Self-define I/O, AD, PWM output, I2C etc.
Stepper motor expand Interface	Yellow port, 4PIN, 12V 1A
12V power interface	Red port, 2PIN, 12V, 3A max
PWM	Value range: 20Hz~100KHz
ADC	Value range: 0V~5V Accuracy: 12bit

Table 3.4 Power Box technical parameters

Name	Power Box
Maximum voltage	12V/1A DC
Power in	12V/5A DC
Power out	12V/3A DC
Rated capacity	2500mAH
Minimum capacity	2400mAH
Working temperature	0°C~40°C
Size	95 mm×80 mm×28.5 mm

Battery energy	27Wh
Power interface	Black port, 4 PIN, 12V-3A max

3.4.2 Sizes

Figure 3.10 shows the size of Magician Lite and Figure 3.11 shows the size of the end mounting hole.

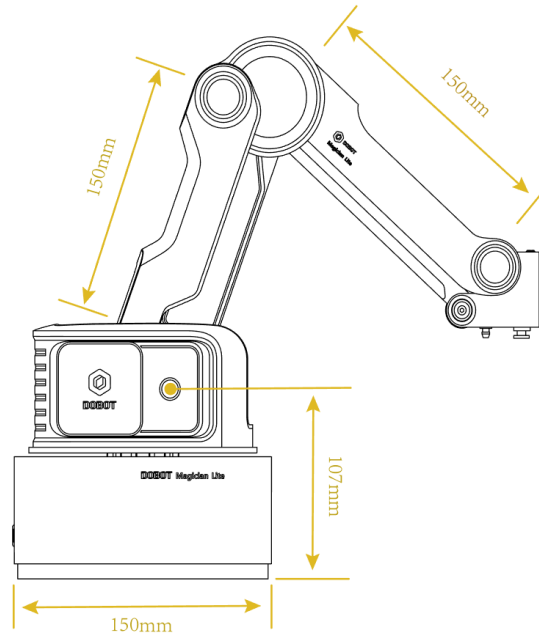

Figure 3.10 Size of Magician Lite

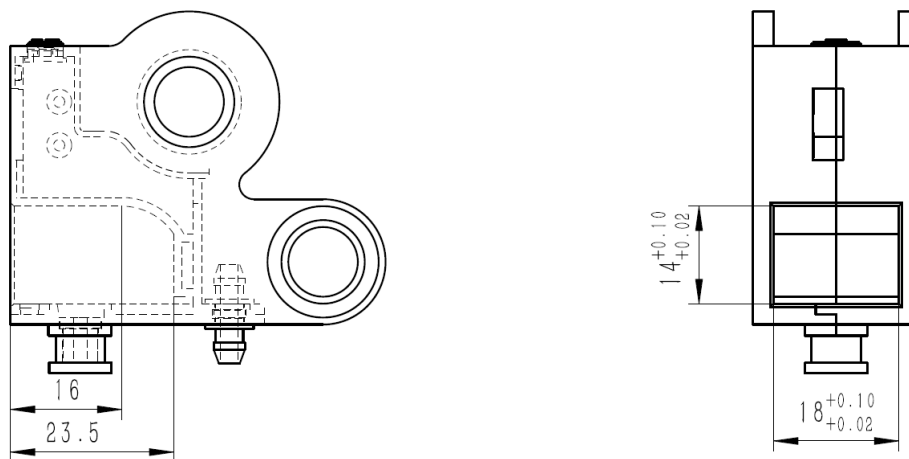

Figure 3.11 Size of end mounting hole

4. Interface Description

4.1 Magician Lite Interface Description

The interfaces of Magician Lite are located on the back of the base. Figure 4.1 shows the interfaces on the back of the base, and Table 4.1 lists the description.

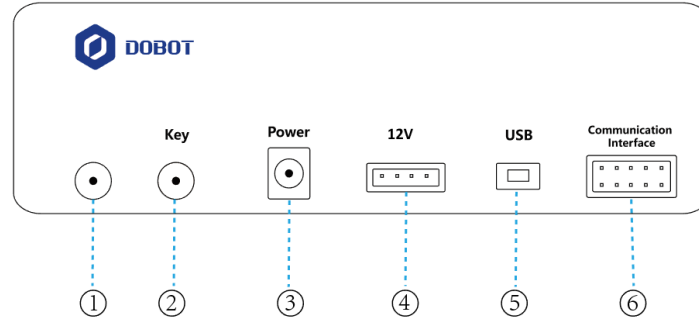

Figure 4.1 Interfaces in the base

Table 4.1 Interface description

No.	Description
1	Power switch Short press: Power on Magician Lite Long press(>3s): Power off Magician Lite
2	Key <ul style="list-style-type: none"> Short press: Start running playback program in offline mode, for the details about offline mode, please refer to 5.4Working in Offline Mode Long press(>2s): Start homing procedure, for the details about homing, please refer to 5.2Homing
3	Power interface Connect to power adaptor
4	12V power interface: To supply power to Magician Lite
5	USB: Connect Magician Lite and your PC
6	10PIN communication interface Serial communication

The LED indicator is located on the base, Table 4.2 lists the status description.

Table 4.2 LED indicator description

State	Description
Green On	Magician Lite works normally
Yellow On	Magician Lite is in the starting status
Blue On	Magician Lite is in the offline mode
Blue Blinking	Magician Lite is running homing procedure
Red On	<ul style="list-style-type: none"> Magician Lite is at the limited position An alarm is not cleared

4.2 Magic Box Interface Description

The Magic Box interface consists of 24 I/O multiplexing interfaces as well as communication interfaces that connect sliding rail, conveyor belts, Joystick, sensors, and more. As shown in the figure below.

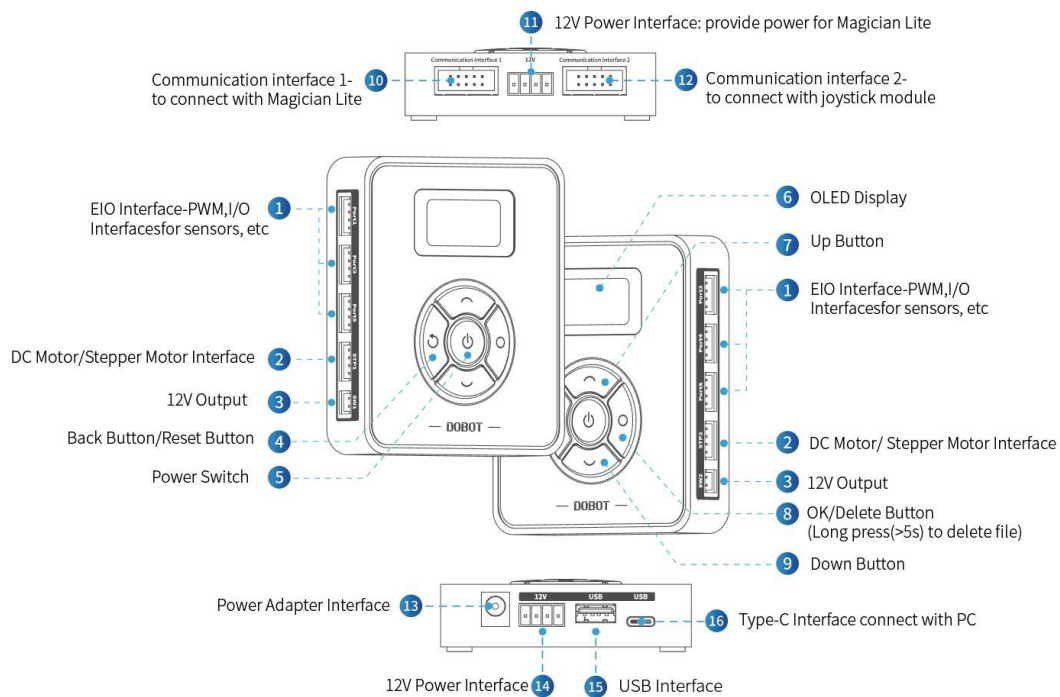

Figure 4.2 Magic Box interfaces

4.3 Power Box Interface

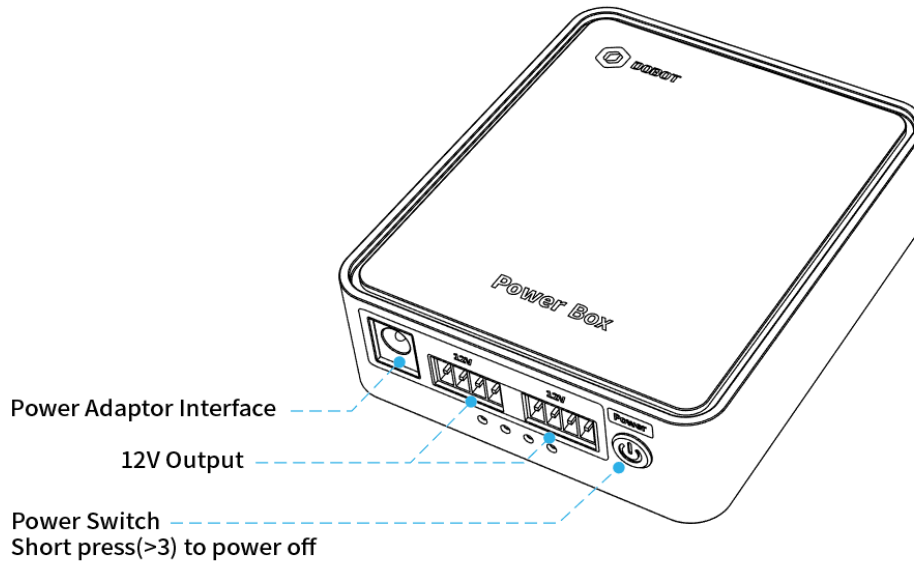

Figure 4.3 Power Box interface description

Table 4.3 Power Box LED description

State	Description
Flashing	In discharge
Water lights	Charging
All on	Charging complete
Turn off after all flashing	Low battery, automatic shutdown
The inside and outside lights flash alternately	The temperature of the Power Box is too high or too low. At this time, the Power Box needs to be left for a period of time until the temperature is within the working temperature range

4.4 Multiplexed I/O Interface Description

The addresses of the I/O interfaces in Magic Box are unified. Most of I/O interfaces have multiple functions, to control the peripheral equipment.

Figure 4.4 shows the communication interface on Magic Box, Table 4.4 lists the multiplexed I/O description.

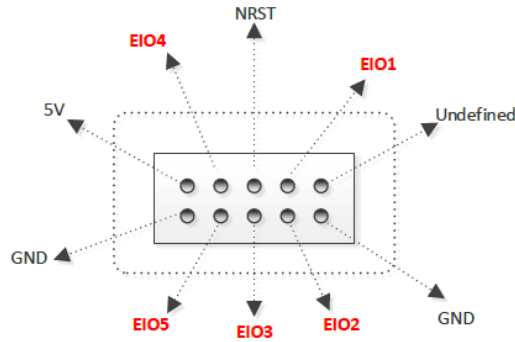

Figure 4.4 Communication Interface 1

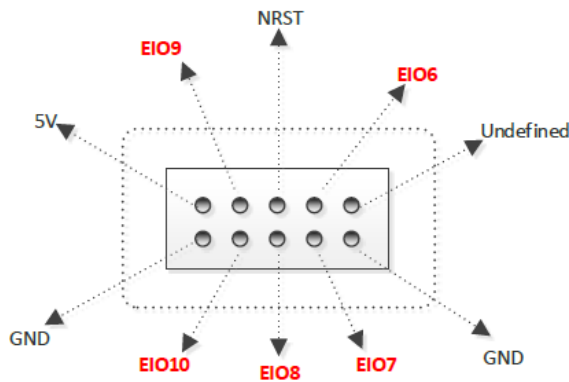

Figure 4.5 Communication Interface 2

Table 4.4 Magic Box multiplexed I/O description

Interface	Pin	Description	Level Output	PWM	Level Input	ADC	Whether Pulling
Communication Interface 1	undefined	-	-	-	-	-	-
	GND	ground	-	-	-	-	-
	EIO1	General I/O interface	3.3V_10mA output	-	3.3V/5V_10mA input	-	No pulling
	EIO2	General I/O interface	3.3V_10mA output	-	3.3V/5V_10mA input	-	No pulling
	Reset	Firmware reset	3.3V_10mA output	-	3.3V_10mA input	-	Pull up 430R to 3.3V
	EIO3	General I/O	3.3V_10mA	-	3.3V_10mA	-	Pull up

Interface	Pin	Description	Level Output	PWM	Level Input	ADC	Whether Pulling
		interface	A output		input		10K to 3.3V
	EIO4	General I/O interface	3.3V_10mA output	-	3.3V/5V_10mA input	-	No pulling
	EIO5	General I/O interface	3.3V_10mA output		3.3V/5V_10mA input	-	No pulling
	5V	power	5V/1A output	-	-	-	-
	GND	ground	-	-	-	-	-
Communication Interface 2	undefined	-	-	-	-	-	-
	GND	ground	-	-	-	-	-
	EIO6	General I/O interface	3.3V_10mA output	-	3.3V/5V_10mA input	-	No pulling
	EIO7	General I/O interface	3.3V_10mA output	-	3.3V/5V_10mA input	-	No pulling
	Reset	Firmware reset	3.3V_10mA output	-	3.3V_10mA input	-	Pull up 430R to 3.3V
	EIO8	General I/O interface	3.3V_10mA output	-	3.3V_10mA input	-	Pull up 10K to 3.3V
	EIO9	General I/O interface	3.3V_10mA output	-	3.3V/5V_10mA input	-	No pulling
	EIO10	General I/O interface	3.3V_10mA output	-	3.3V/5V_10mA input	-	No pulling
	5V	power	5V/1A output	-	-	-	-
	GND	ground	-	-	-	-	-

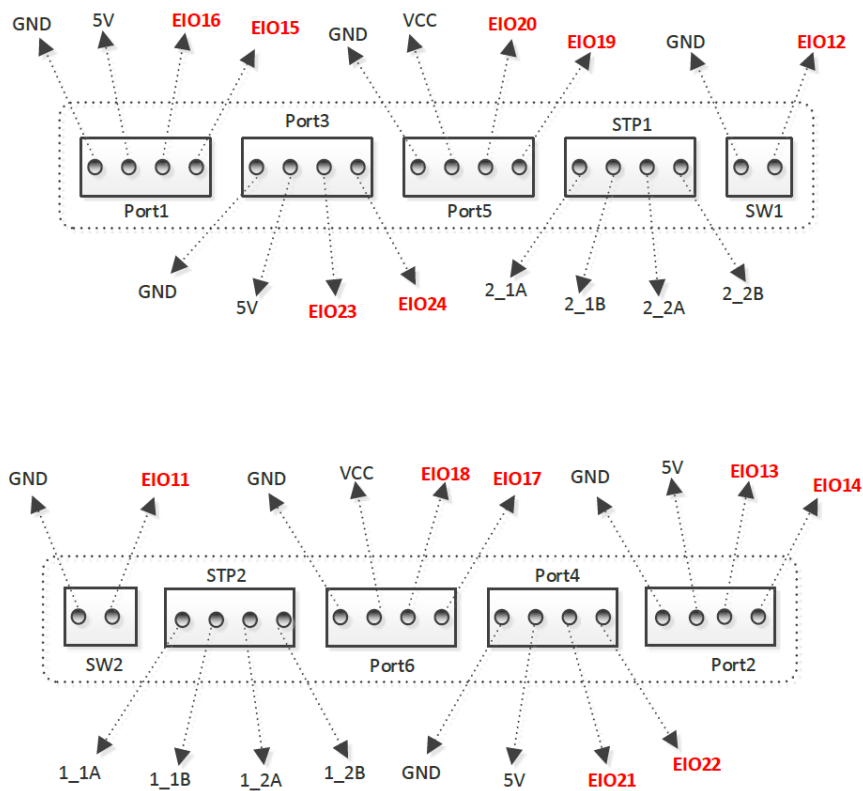

Figure 4.6 Peripheral interface

Table 4.5 Peripheral multiplexed I/O description

Interface	Pin	Description	Level Output	PWM	Level Input	ADC	Whether Pulling
SW1	EIO12	Controlled power	8V~12.6V _3A output	-	-	-	-
	GND	Ground	-	-	-	-	-
SW2	EIO11	Controlled power	8V~12.6V _3A output	-	-	-	-
	GND	Ground	-	-	-	-	-
STP1	2_1A	-	8V~12.6V /0.9A output	-	-	-	-
	2_1B			-	-	-	-
	2_2A			-	-	-	-
	2_2B			-	-	-	-

Interface	Pin	Description	Level Output	PWM	Level Input	ADC	Whether Pulling
STP2	1_1A			-	-	-	-
	1_1B			-	-	-	-
	1_2A			-	-	-	-
	1_2B			-	-	-	-
Port1	GND	Ground	-	-	-	-	-
	5V	Power	5V/1A	-	-	-	-
	EIO16	General I/O interface	3.3V_10mA output	√	3.3V_10mA input	-	Pull up 51K to 3.3V
	EIO15	General I/O interface	3.3V_10mA output	-	3.3V_10mA input	-	Pull up 51K to 3.3V
Port2	GND	Ground	-	-	-	-	-
	5V	Power	5V/1A	-	-	-	-
	EIO13	General I/O interface	3.3V_10mA A output	√	3.3V_10mA input	-	Pull up 51K to 3.3V
	EIO14	General I/O interface	3.3V_10mA A output	-	3.3V_10mA input	-	Pull up 51K to 3.3V
Port3	GND	Ground	-	-	-	-	-
	5V	Power	-	-	-	-	-
	EIO23	General I/O interface	3.3V_10mA A output	√	3.3V_10mA input	-	No pulling
	EIO24	General I/O interface	3.3V_10mA A output	-	3.3V_10mA input	√	No pulling
Port4	GND	Ground	-	-	-	-	-
	5V	Power	-	-	-	-	-
	EIO21	General I/O interface	3.3V_10mA A output	√	3.3V_10mA input	-	No pulling

Interface	Pin	Description	Level Output	PWM	Level Input	ADC	Whether Pulling
	EIO22	General I/O interface	3.3V_10mA output	-	3.3V_10mA input	√	No pulling
Port5	GND	Ground	-	-	-	-	-
	5V	Power	5V/1A output	-	-	-	-
	EIO20	General I/O interface	3.3V_10mA output	√	3.3V_10mA input	-	Pull up 51K to 3.3V
	EIO19	General I/O interface	3.3V_10mA output	√	3.3V_10mA input	-	Pull up 51K to 3.3V
Port6	GND	Ground	-	-	-	-	-
	5V	Power	5V/1A output	-	-	-	-
	EIO18	General I/O interface	3.3V_10mA output	√	3.3V_10mA input	-	Pull up 51K to 3.3V
	EIO17	General I/O interface	3.3V_10mA output	√	3.3V_10mA input	-	Pull up 51K to 3.3V

5. Operation

5.1 Introduction to the DobotStudio

5.1.1 Function Modules

You can use the DobotStudio to control the Magician Lite to accomplish multiple functions such as **Teaching & Playback**, **Write & Draw**, **Blockly** graphics programming, and **Script** control, as shown in Figure 5.1. For details, refer to Table 5.1.

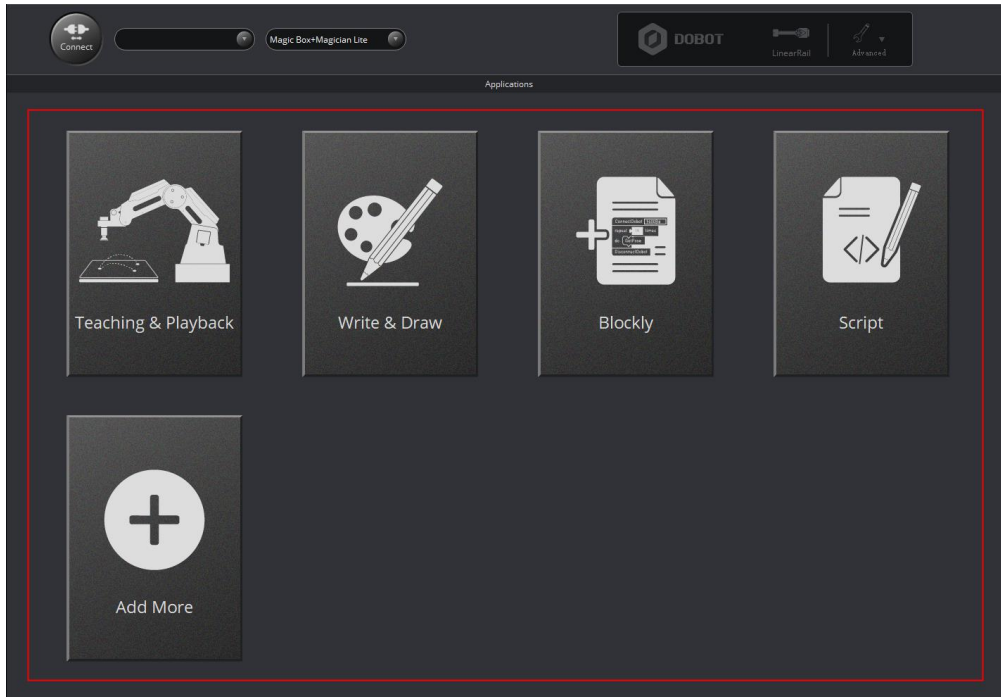

Figure 5.1 The function modules on the DobotStudio page

Table 5.1 The function modules on the DobotStudio page

Function Modules	Description
Teaching & Playback	Teach Magician Lite how to move and then record the movement to make Magician Lite accomplish the recorded movements
Write & Draw	Control Magician Lite to write, draw, or engrave an object using a laser
Blockly	Use Blockly to program Magician Lite in a graphics programming environment. It allows the users to drag and drop the blocks onto a workplace to generate execute code just as intuitive and easy as a block puzzle
Script	Control Magician Lite using the script commands
Add More	Add more custom functions to manipulate Magician Lite

You can also set the Magician Lite by clicking **Setting** on the DobotStudio page as shown in Figure 5.2. For details, please refer to Table 5.2.

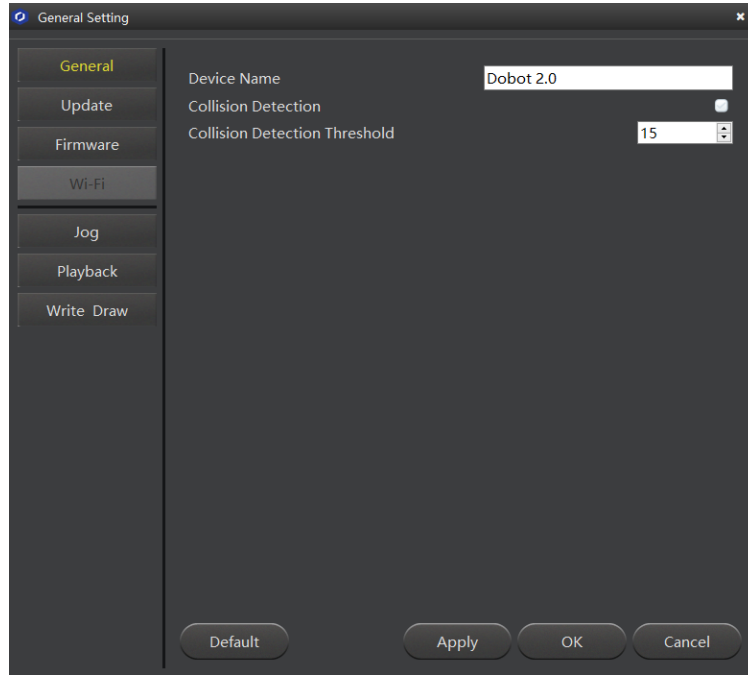

Figure 5.2 The General Setting page

Table 5.2 The General Setting page

Items	Description
General	Set a device name and collision detection
Update	Set firmware detection frequency and view the current firmware, software version
Firmware	Upgrade firmware DobotStudio displays different firmware when connecting different devices. When connecting Magician Lite, firmware shows Magician Lite firmware . You can click Confirm to upgrade firmware.
Jog	Set the jogging speed ratio
Playback	Set speed ratio, Jump parameters, handhold teaching, and LostStepParam.
Write Draw	Set the Write & Draw function, such as speed ratio, pen up offset and pen down position.

5.1.2 Common Areas of DobotStudio Page

The DobotStudio offers the following common areas shared by all the function modules to control the robotic arm.

- You can select the liner rail or an end-effector on the DobotStudio page, as shown in Figure 5.3.

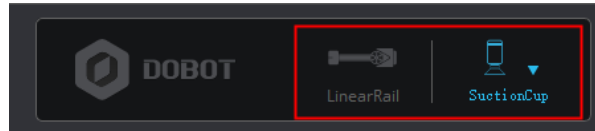

Figure 5.3 The linear rail and end-effector drop-down list

Table 5.3 The linear rail and end-effector drop-down list

Items	Description
Linear rail	When Magic Box+Magician Lite is connected to a linear rail, click this item to enable the rail
End-effector drop-down list	When the end-effector is a suction cup kit, gripper kit, or writing and drawing kit, select the corresponding kit in this list

- You can also perform other operations on the DobotStudio page such as Setting, Home, Emergency Stop, and viewing the versions, as shown in Figure 5.4.

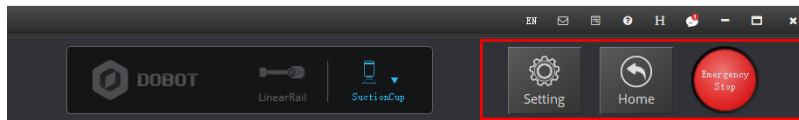

Figure 5.4 Setting, Home, Emergency Stop, and viewing the versions

Table 5.4 Setting, Home, Emergency Stop, and viewing the versions

Items	Description
Setting	Set the robotic arm such as firmware upgrade, sensor and base setup. For details, please refer to Table 5.2
Home	Set Magician Lite back to its home position When the robotic arm loses step, please press the button on forearm to restore encoder value.
Emergency Stop	Stop the robotic arm if an emergency occurs
	View the version information such as DobotStudio version, firmware version, and hardware version
	Switch system language

With the **Operation Panel** on the **DobotStudio** page, you can teach the robotic arm to perform a specific task such as jogging the robotic arm in the Cartesian or joint coordinate system, or controlling a gripper or suction cup, as shown in Figure 5.5. For details, please refer to Table 5.5.



Figure 5.5 Setting the Operation Panel

Table 5.5 Setting the Operation Panel

Items	Description
Coordinate jogging	Jog Magician Lite by clicking X (X+/-), Y (Y+/-), Z (Z+/-), or R (R+/-) in the Cartesian coordinate system
Joint jogging	Jog Magician Lite by clicking J1+/-, J2+/-, J3+/-, or J4+/- in the Joint coordinate system
Linear control	When the linear rail is enabled (refer to Table 5.3), click L+/- to move the robotic arm along the rail. Value range: 0 mm - 1000 mm NOTE The rail function is only available when connecting Magic Box + Magician Lite
Gripper control	When the end-effector is chosen as a Gripper , you can set the gripper to open, close, or disable in the Gripper drop-down box
Suction cup control	When the end-effector is chosen as a Suction Cup , select SuctionCup to power on the air pump. If unselected, the air pump is powered off
Jogging speed control	Set the jogging speed percentage Default value: 50% Value range: 1% - 100%

5.2 Homing

Magician Lite has been calibrated before being shipped out. When Magician Lite backs to the homing position, which will not calibrate accuracy, If Magician Lite has been hit or the motor has lost a step, leading data abnormal, you need to press the button on forearm to restore encoder value.

Prerequisites

- Magician Lite has been powered on.
- Magician Lite has been connected to DobotStudio successfully.

Procedure

Click **Home** on the DobotStudio page, as shown in Figure 5.6.



- Please remove the end-effector from Magician Lite before homing.
- Please ensure that there are no obstacles in the workspace during homing.

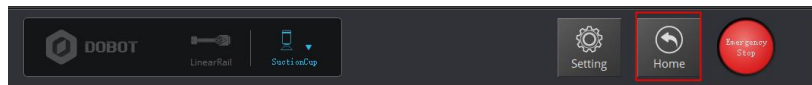

Figure 5.6 Operate homing

Magician Lite will rotate to the default homing point automatically and the LED indicator on the base turns blue and is blinking. After the homing is successful, there is a beep sound and the LED indicator turns green.

Also, the homing point can be user-defined, you can select a saved point on the **Teachong&Playback** page and right-click **SetHome** to set this saved point as the homing point, as shown in Figure 5.7.

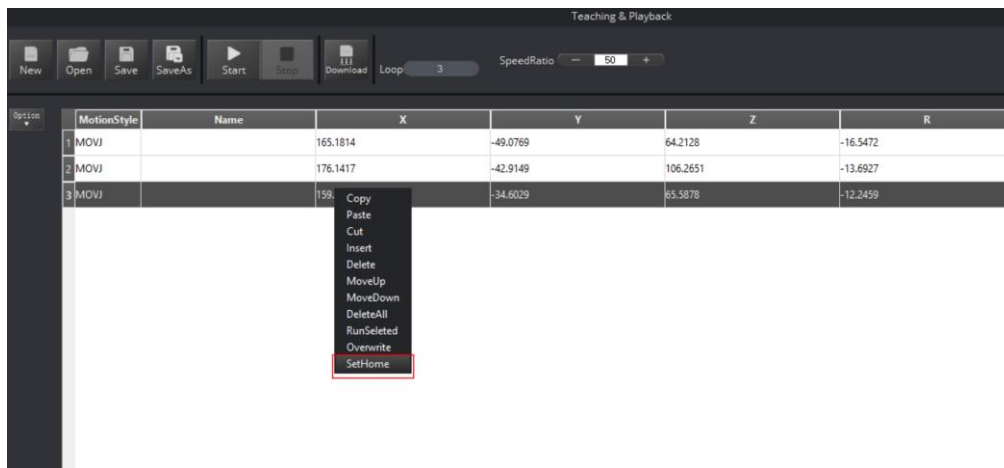

Figure 5.7 Set homing point

5.3 Performing Teaching & Playback Tasks

This topic introduces how to perform a teaching & playback task to suck or grab a small cube. Because a suction cup kit or a gripper kit is required, we will explain them first.

5.3.1 Installing a Suction Cup Kit

Magician Lite has built-in air pump with suction cup as the default end-effector, as shown in

Figure 5.8.

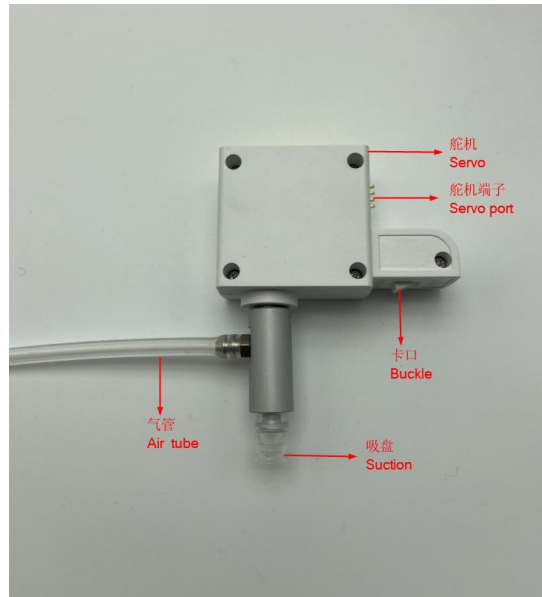

Figure 5.8 A suction cup kit

Procedure

- Step 1** Insert a suction cup kit into the end's port, hear a sound indicating that the suction cup is fixed and complete, as shown in Figure 5.9.

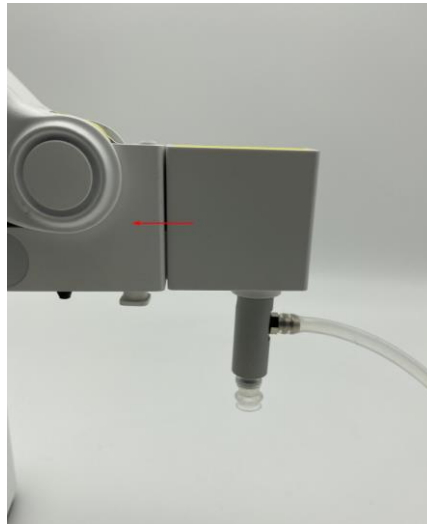

Figure 5.9 Install a suction cup kit

- Step 2** Connect the air pump's air tube to the air tube connector of the suction cup kit, as shown in Figure 5.10.



Figure 5.10 Install an air tube

5.3.2 Installing a Gripper Kit

An air pump should be used with the gripper kit, as shown in Figure 5.11, to open or close the gripper.

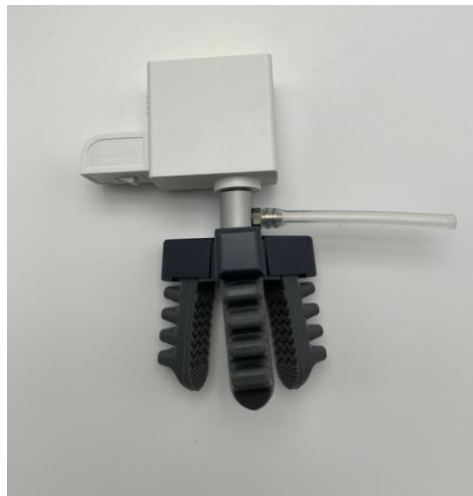

Figure 5.11 A gripper kit

Install the gripper kit to Magician Lite in the same way as the suction cup kit is installed. For details, please refer to *5.3.1 Installing a Suction Cup Kit*. Figure 5.12 shows the effect of the gripper kit installation.

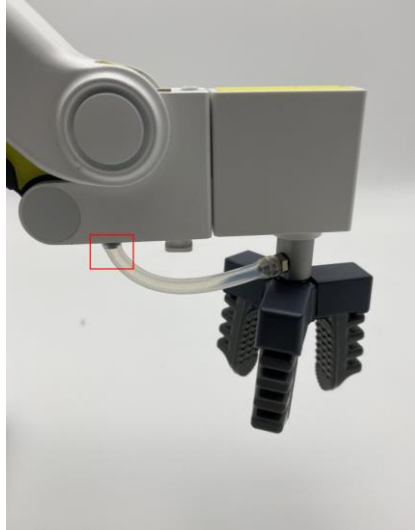

Figure 5.12 The effect of the gripper kit installation

5.3.3 Teaching & Playback Page

The **Teaching & Playback** page is shown in Figure 5.13 when connect to **Magic Box+Magician Lite**. To access it, select **Connect > Teaching & Playback** on the **DobotStudio** page.

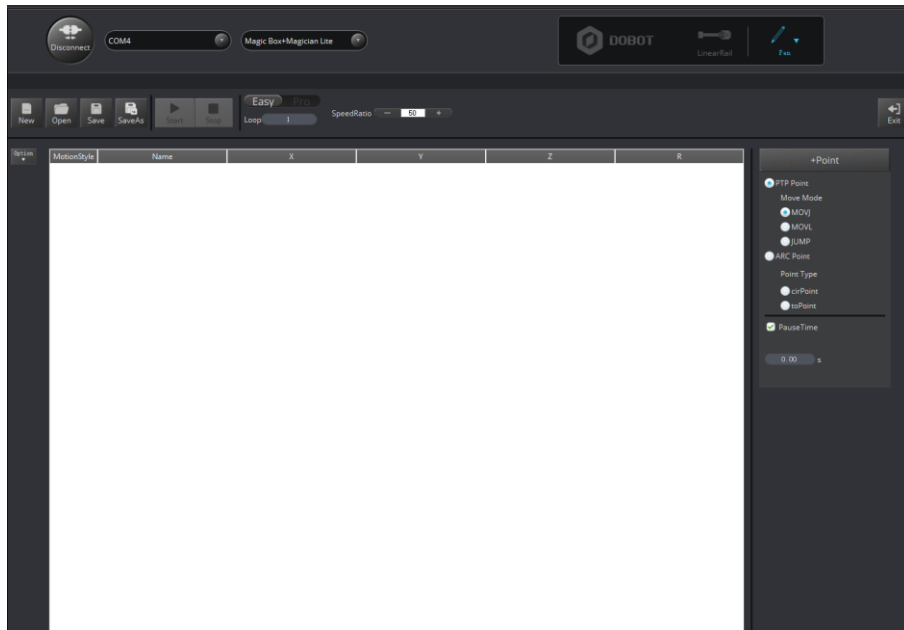

Figure 5.13 The Teaching & Playback page

- You can switch mode between **Easy** and **Pro** modes, set loop, speed ratio, as shown in Figure 5.14.

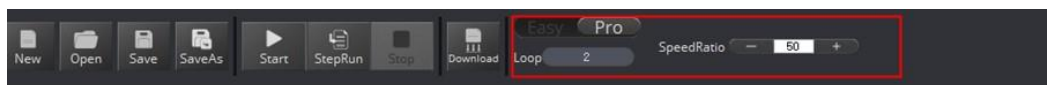

Figure 5.14 Set Easy/Pro, Loop, Speed

Table 5.6 Set Easy/Pro, Loop, Speed ratio

Items	Description
Easy/Pro	Click this slider to switch between Easy and Pro modes. The default is the Easy mode Apart from all the functions in the Easy mode, the Pro mode offers multiple features such as the offline mode and multiplexed I/O interface NOTE The Pro mode is only available when connecting Magic Box + Magician Lite .
Loop	Set the loop that the robotic arm plays back the recorded steps Default value: 1 Value range: 1 - 999999
Speed	Set the speed ratio when doing playback Default value: 50% Value range: 0% - 100%
Exit	Exit the current Teaching & Playback page to return to the DobotStudio page

- In both **Easy** and **Pro** modes, you can save points, set the motion mode and the pause time for a save point, as shown in Figure 5.15.

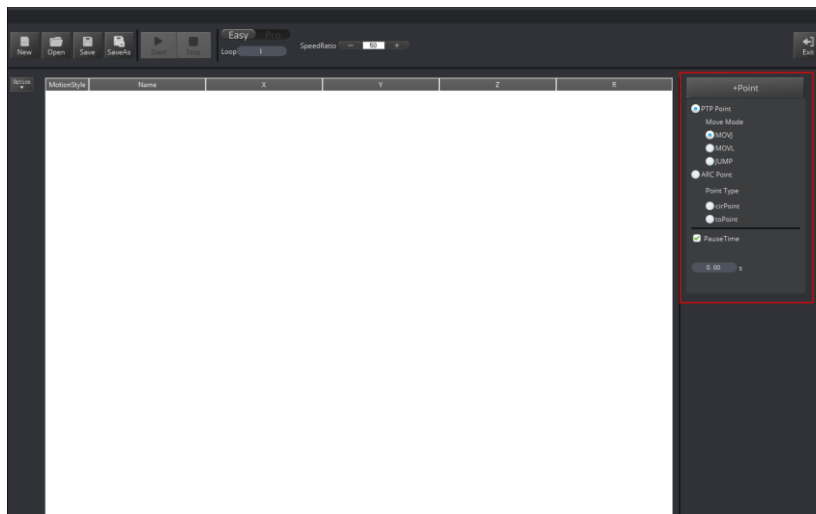

Figure 5.15 Set the save points, motion modes and pause time

Table 5.7 Set the save points, motion modes, and pause time

Items	Description
+Point	Click to create a new save point in the Save points list
Move mode	Choose a PTP (point to point) Point mode or ARC Point mode. In the PTP Point mode, you can select MOVJ, MOVL, or JUMP mode while the ARC Point mode requires a second point toPoint and a finish point toPoint as well as the start point set via the PTP Point mode
Pause time	Set the pause time for a saving point

- In both **Easy** and **Pro** modes, you can edit a highlighted save point such as copy, paste, cut, switch between motion modes, modify name and coordinates, as shown in Figure 5.16.

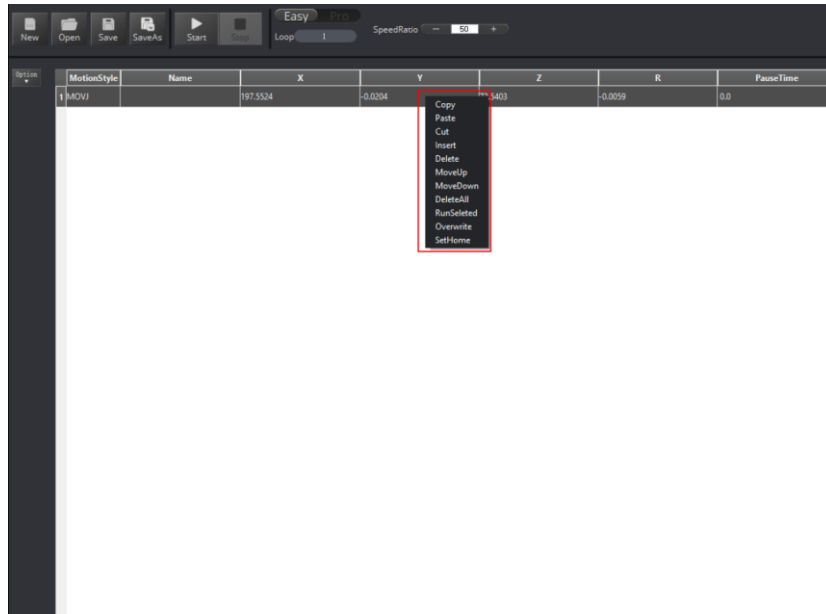

Figure 5.16 The Save points list

Table 5.8 The Save points list

Items	Description
A right-click mouse operation	In the right-click popup menu you can edit a highlighted save point such as copy, paste, cut, insert, and delete, as shown in Figure 5.16
A double-click mouse operation	Double-clicking a cell to modify its value

- **Pro** mode: To enter the **Pro** mode from the current **Easy** mode, click the **Easy/Pro** slider, as shown in Figure 5.17. Apart from all the functions in the default **Easy** mode, the **Pro** mode allows the robotic arm to run a save point each time, detect lost-steps, work in offline mode, and perform the multiplexed I/O interface. For details, refer to Table 5.9.

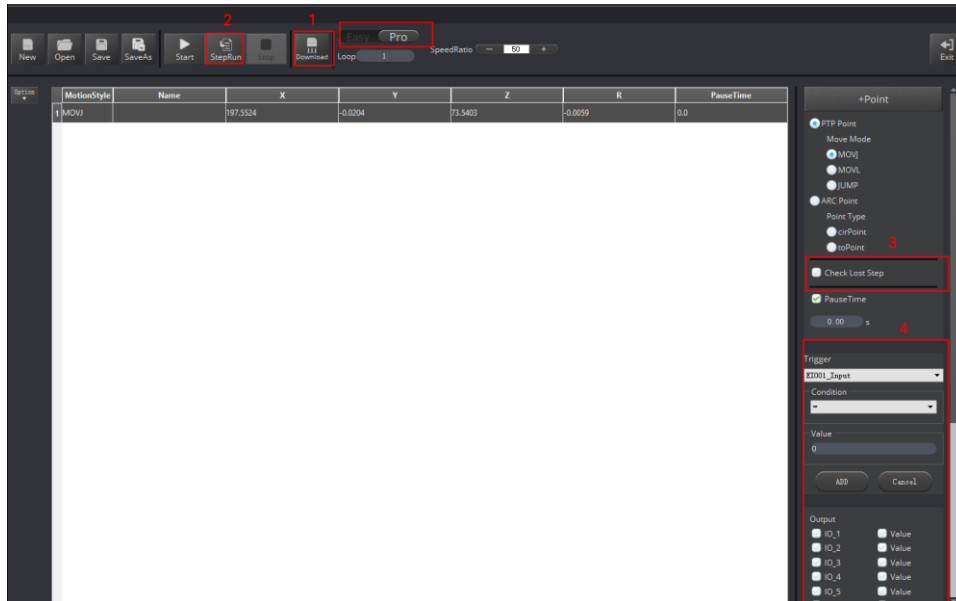

Figure 5.17 The Pro mode of the Teaching & Playback function

Table 5.9 The Pro mode of the Teaching & Playback function

No.	Description
1	StepRun: run a save point each time in the Save points list. Before clicking StepRun , please select a saved point
2	Download: download the Save points list to Magician Lite or Magic Box for working in offline mode. For details, see <i>5.4 Working in Offline Mode</i>
3	Check Lost Step: Magician Lite detects if lost-steps occur in its movements. The default threshold is 8°. Value range: 8°~15°. You can set the threshold by selecting Setting > Playback > LostStepParam If Check Lost Step is selected, the robotic arm detects if the stepper motors lose steps when moving. If unselected, no detection is performed If Magician Lite detects lost-steps, it stops working, and its LED indicator turns red. In this case, click Home to get a correct reference position
4	Multiplexed I/O interface: control Magician Lite via the I/O interfaces such as turning on or off the air pump

5.3.4 ARC Motion Mode

Application Scenarios

The **ARC** motion mode requires three points in an arc to complete the arc movement process. In the **ARC** motion mode, only the second point and end point are saved while the start point is determined by the other modes.

Prerequisites

Magician Lite has been powered on and connected to your computer.

Procedure

NOTICE

Note the following rules when saving points to prevent the robotic arm from working outside its normal workspace.

- Any two points cannot coincide.
- The three points cannot be in the same straight line.
- The arc trajectory cannot exceed the Magician Lite normal workspace.

For example, the points A, B, and C are on the arc. Point A is the start point; Point B is the second point; Point C is the endpoint, as shown in Figure 5.18.

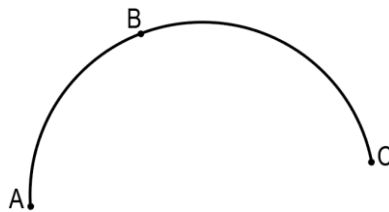

Figure 5.18 The arc trajectory

Step 1 Click **Teaching & Playback**.

The **Teaching & Playback** page is displayed.

Step 2 Save the start point A.

1. Select **MOVJ** motion mode in the Save Point area.

2. Click  to display the **Operation Panel**, as shown in Figure 5.19.

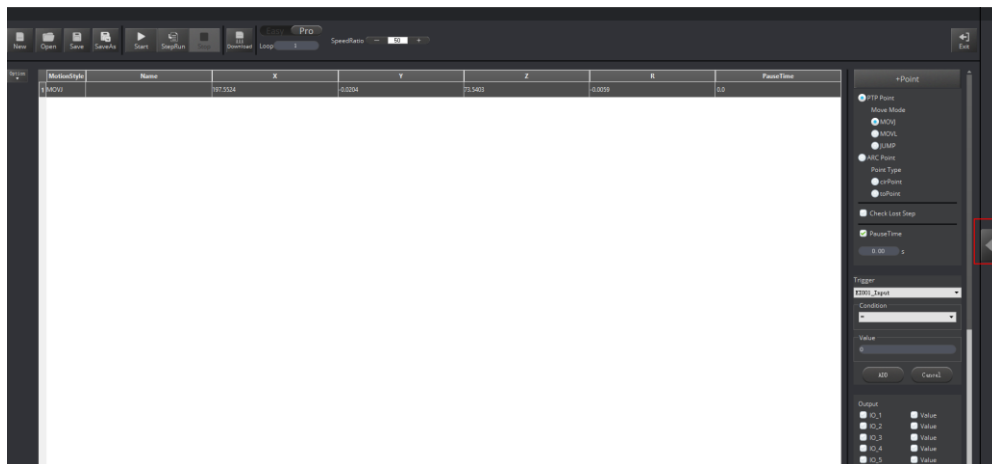

Figure 5.19 Display the Operation Panel

3. Set the jogging speed percentage to **50** on the **Operation Panel**.
4. Jog Magician Lite in the Cartesian or Joint coordinate system to move the robotic arm to a location called position A.
5. Click **+Point** to save the coordinate corresponding to the position A, as shown in Figure 5.20.

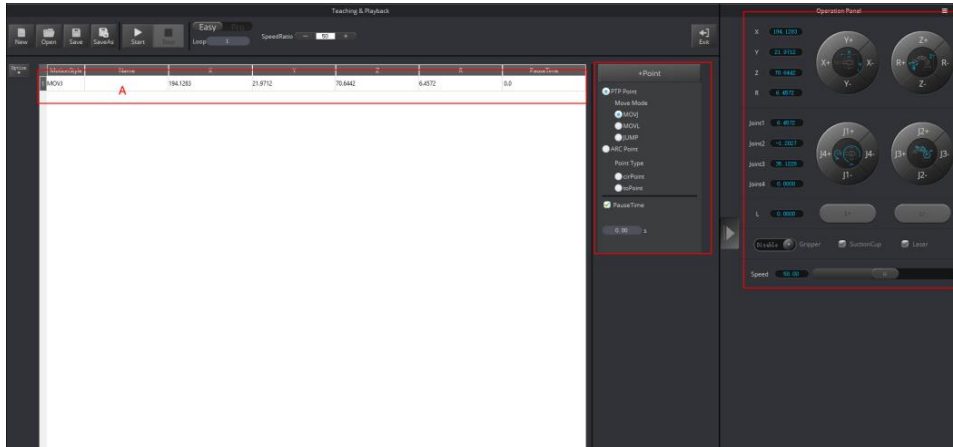

Figure 5.20 Save the start position A

Step 3 Save the second point B and the endpoint C.

1. Select **cirPoint** to save the second point in the Save Point area.
2. Jogging Magician Lite in the Cartesian or Joint coordinate system to move the robotic arm to the second position B as required.
3. Click **+Point** to save the coordinate corresponding to the position B. In this case, the DobotStudio automatically changes the motion mode to **toPoint** to get ready to save the end position.
4. Jogging Magician lite in the Cartesian or Joint coordinate system to move the robotic arm to the end position C as needed.
5. Click **+Point** to save the coordinates corresponding to the positions B and C, as shown in Figure 5.21.

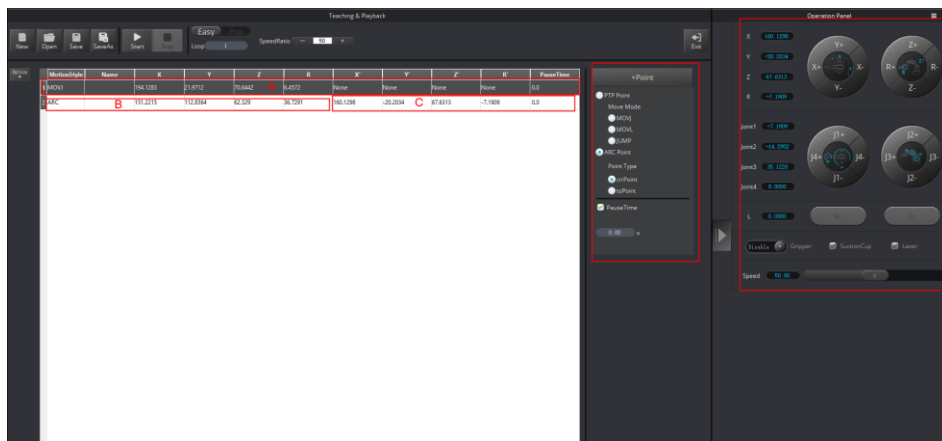

Figure 5.21 Save the second position B and the end position C

- Step 3** Set the percentage of speed for playback, such as 50.
- Step 4** Set **Loop** to **2**.
- Step 5** Click **Start**. Magician Lite performs the sequence of ARC trajectory as taught from its memory system, moving from positions A through C, as shown in Figure 5.22.

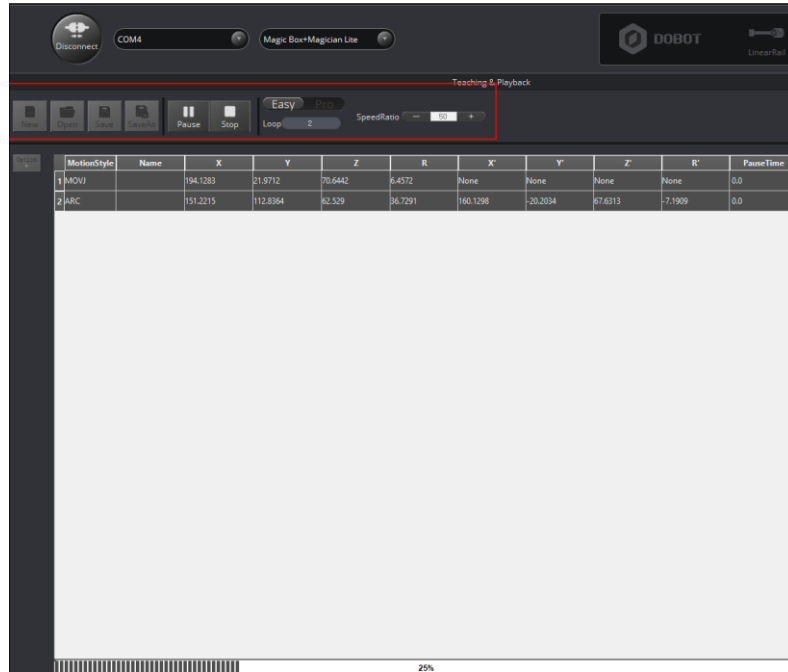

Figure 5.22 Move the small cube in the ARC motion mode

5.3.5 Teaching & Playback Example

Application Scenarios

You can use the Teaching & Playback function module to manipulate Magician Lite to accomplish different tasks such as transportation or intelligent sort. This topic introduces how to move small cubes from position A to B in the **JUMP** motion mode.

Prerequisites

- Magician Lite has been powered on and connected to your computer.
- A suction cup kit has been installed. For details, see *5.3.1 Installing a Suction Cup Kit*.

Procedure

- Step 1** Choose **SuctionCup** as the end-effector on the **DobotStudio** page, as shown in Figure 5.23.

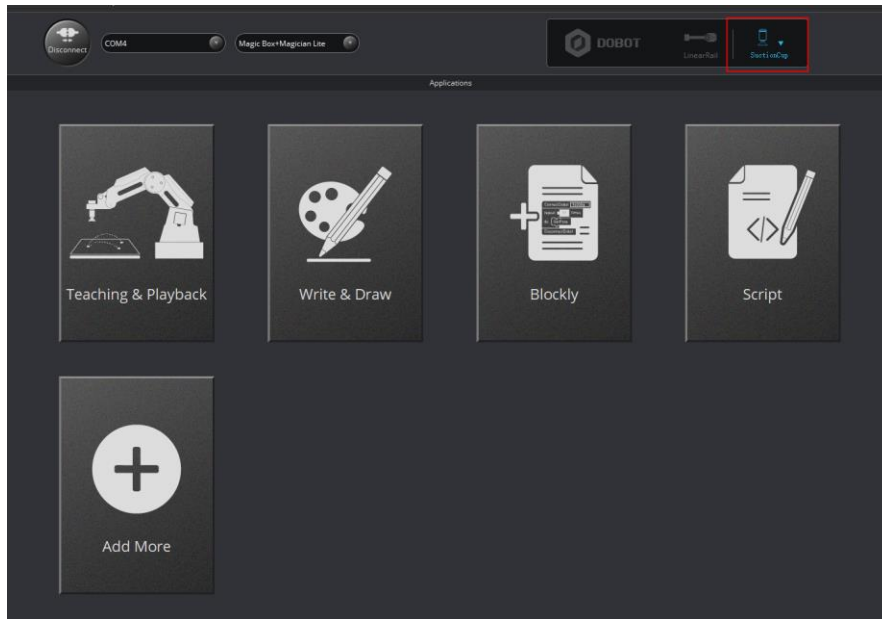

Figure 5.23 Choose SuctionCup as the end-effector

Step 2 Click **Teaching & Playback**.

The **Teaching & Playback** page is displayed.

Step 3 Save the start point A.

1. Put a small cube on the work surface near the suction cup kit.
2. Select the **MOVJ** motion mode in the Save Point area.

3. Click  to display the **Operation Panel**, as shown in Figure 5.24.

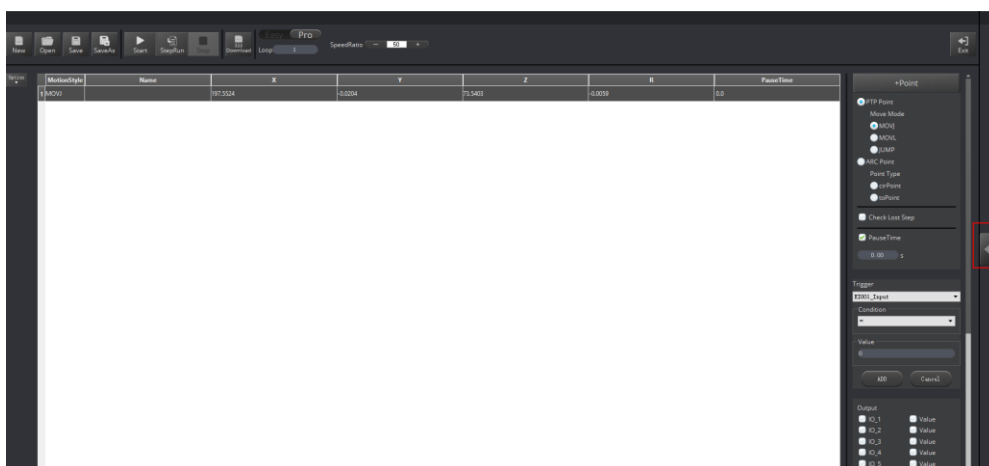

Figure 5.24 Display the Operation Panel

4. Set the jogging speed percentage to **50** on the **Operation Panel**.

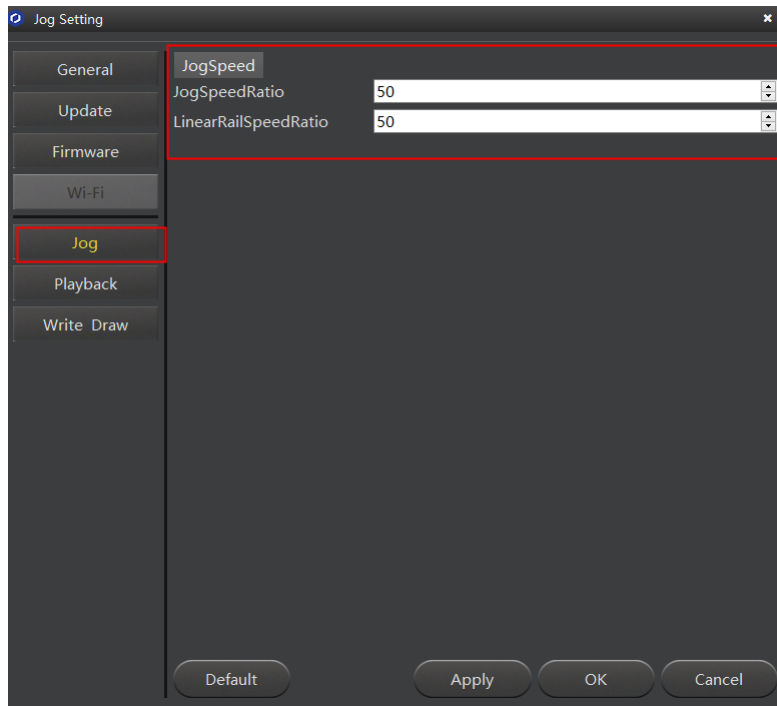

Figure 5.25 Set jogging speed ratio

5. Jog Magician Lite in the Cartesian or Joint coordinate system to move the suction cup close enough to the small cube for picking-up. For example, the suction cup reaches this location called position A.
6. Select **SuctionCup** on the **Operation Panel** to turn on the air pump to pick up the small cube.
7. Set the **PauseTime** to **1** second in the Save Point area.
8. Click **+Point** to save the coordinate corresponding to the position A, as shown in Figure 5.26.

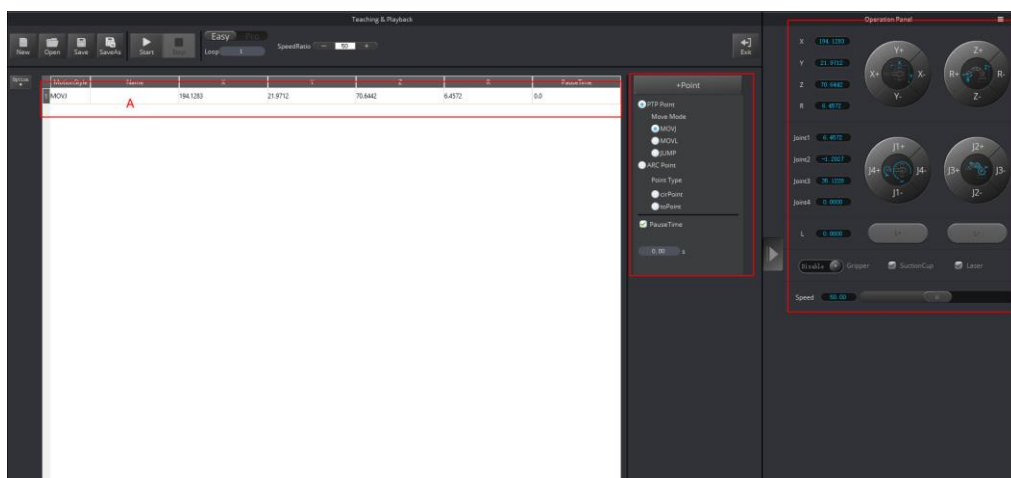

Figure 5.26 Save the start position A

Step 4 Save the endpoint B.

1. Select the **JUMP** motion mode in the saving point area.

NOTE

To change the jogging speed percentage, drag the speed slider.

2. Set the lifting height (**JumpHeight**) and the maximum lifting height (**Z Limit**) by selecting **Setting > Playback > JumpParam**, as shown in Figure 5.27.

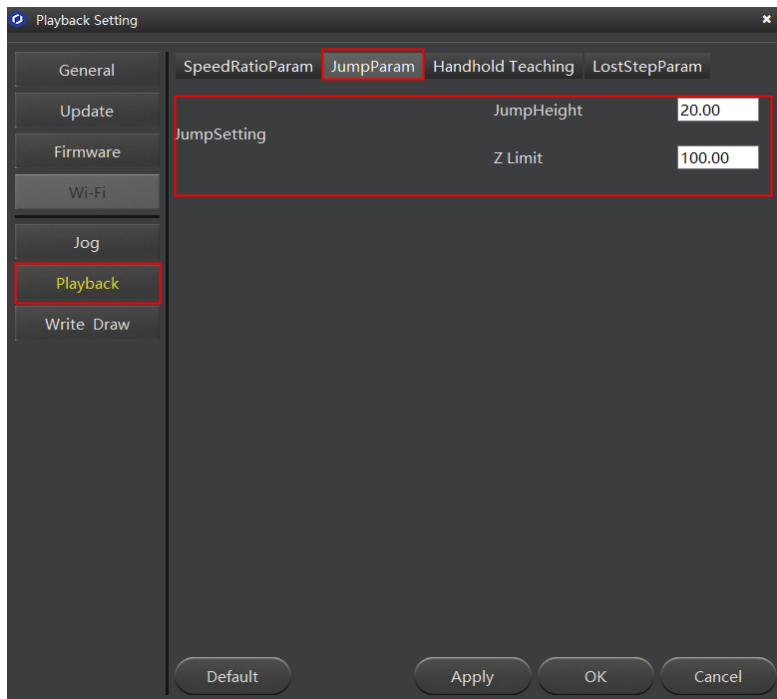

Figure 5.27 Jump parameters

3. Jogging Magician Lite in the Cartesian or Joint coordinate system to move the small cube to the end position B as required.
4. Unselect **SuctionCup** to turn off the air pump to release the small cube.
5. Click **+Point** to save the coordinate corresponding to the position B, as shown in Figure 5.28.

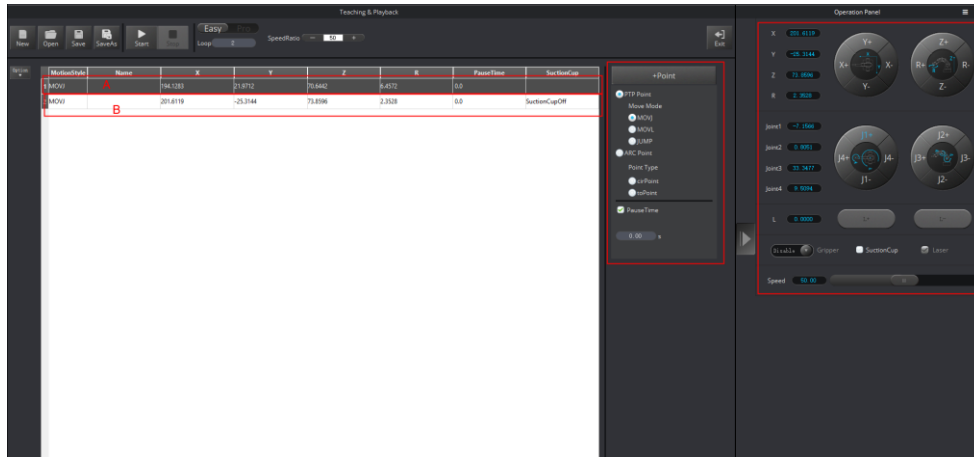

Figure 5.28 Save the end position B

Step 5 Set the percentage of speed for playback, such as 50.

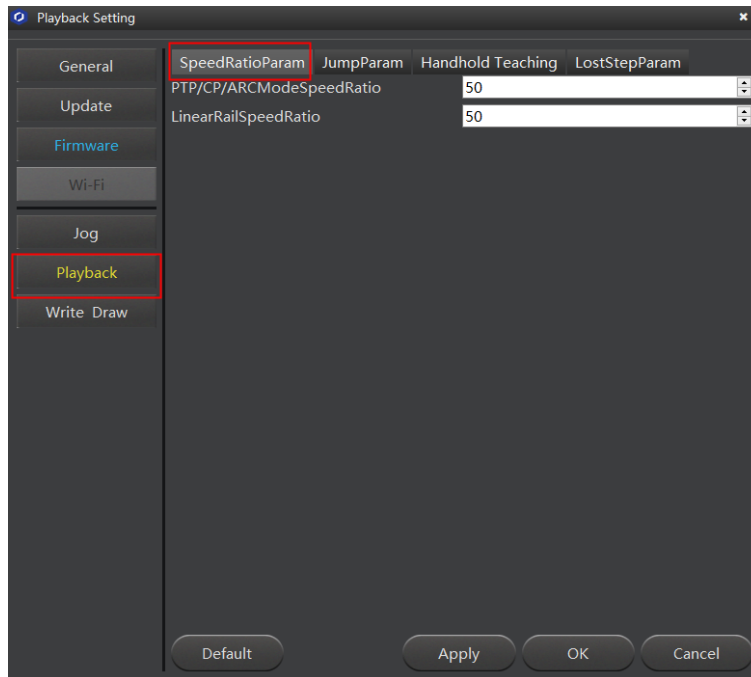

Figure 5.29 Set the speed ratio of the playback

Table 5.10 Set the Playback

Items	Description
SpeedRatioParam	Set speed ratio of Magician Lite and linear rail
JumpParam	Set the Jump height and Z limit, which are required in the JUMP motion mode
Handhold Teaching	Enable or disable handhold teaching. Automatically saves a point when releasing the unlock button or pressing this button

Items	Description
LostStepParam	Set the lost-step checking threshold, The default threshold is 8°. Value range: 8°~15°

Step 6 Set **Loop** to **2**.

Step 7 Place the small object back to position A, and click **Start**. Magician Lite performs the sequence of **JUMP** trajectory as taught from its memory system, moving the small cube from positions A through B.

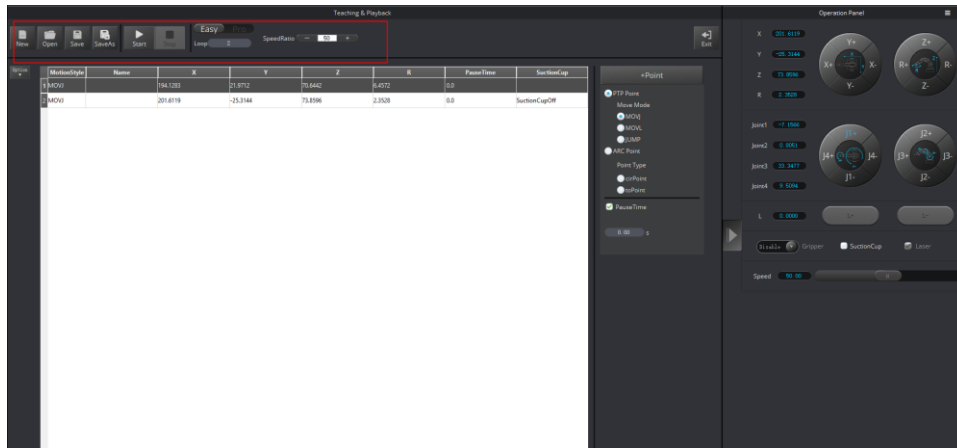

Figure 5.30 Move the small cube in the JUMP motion mode

5.4 Working in Offline Mode

Magician Lite and Magic Box support offline mode, they download a saving list and perform it without keeping the USB connection. We will take Magic box as an example in this chapter.

Prerequisites

- Magic Box+Magician Lite has been powered on.
- Magic Box+Magician Lite has been connected to the DobotStudio.
- The points have been saved.

Procedure

Step 1 Click the **Easy/Pro** slider to enter the **Pro** mode on the **Teaching & Playback** page.

Step 2 Click Download.

The **Question** dialog box is displayed, asking if you want Magician lite to automatically to go back to its homing point before performing the save points in the offline mode, as shown in Figure 5.31.

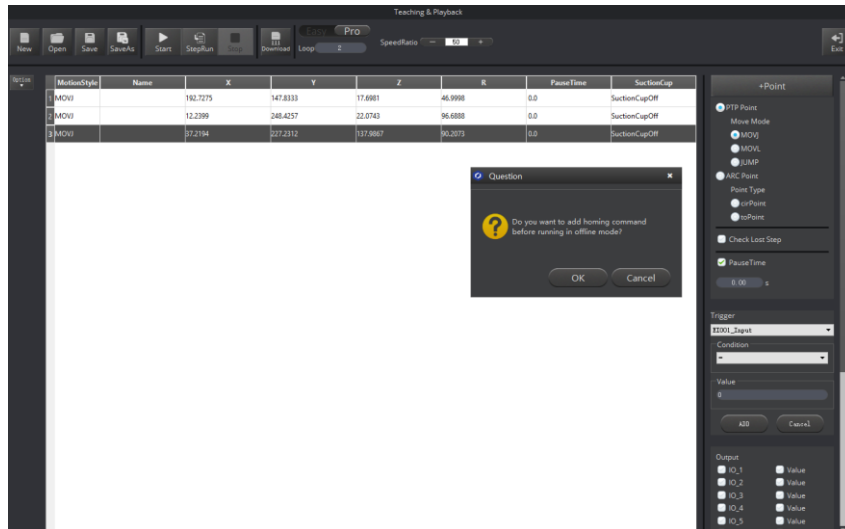
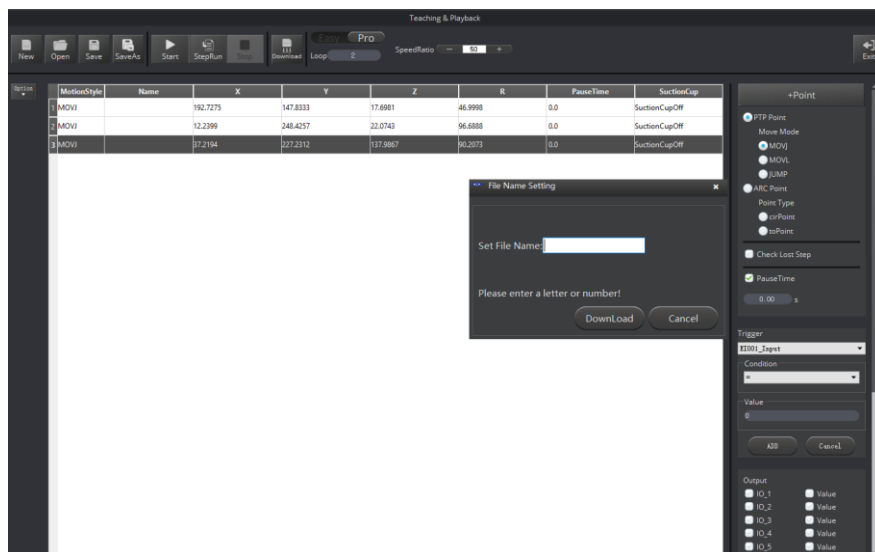

Figure 5.31 Click Download

Step 3 Click OK.

The **Name** dialog box is displayed, input the name of download save points, and click **Download** as shown in Figure 5.32.

 Figure 5.32 The process bar at the bottom of the **DobotStudio** page

Step 4 Disconnect the DobotStudio from **Magic Box+Magician Lite** or the USB cable between Magic Box and your computer.

Step 5 Find the download save points in the path **PlayBack** in Magic Box, click the OK button on Magic Box to perform downloaded save points



NOTICE

When connecting only Magician Lite, Save points are downloaded to Magician Lite, you have to disconnect the DobotStudio from **Magician Lite** or the USB cable between Magician Lite and your computer, and then press the button **Key** on the base of Magician Lite to perform the downloaded save points.

5.5 Writing and Drawing

Figure 5.33 shows the process of writing and drawing.

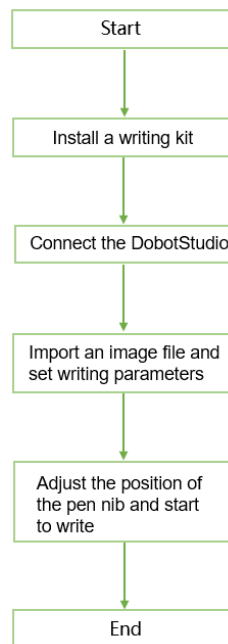

Figure 5.33 The process of writing and draw

5.5.1 Installing a Writing and drawing kit

A writing and drawing kit consists of a pen and a pen holder. For detailed steps, see below.

Step 1 Install a pen in the pen holder.

Step 2 Insert the writing and drawing kit to the end of Magician Lite, hear a sound indicating that the writing and drawing kit is fixed and complete, as shown in Figure 5.34.



Figure 5.34 Install a writing and drawing kit

 NOTE

- When using the pen for the first time, unscrew the suction tube inside the pen, and then replace it with the ink tube that came with the box. After replacement, keep the pen straight down for 2 minutes to use it. As shown in Figure 5.35.



Figure 5.35 Change ink-straw

- If you want to absorb ink, please remove pen-cap and rotate suction tube to absorb ink as shown in Figure 5.36.



Figure 5.36 Absorb ink

Step 3 Position a sheet of paper on the work surface within the workspace of Magician Lite.

5.5.2 Connecting the DobotStudio

Step 1 Launch the DobotStudio, and select device type and COM port (take Magician Lite as an example), and then click **Connect**, as shown in Figure 5.37

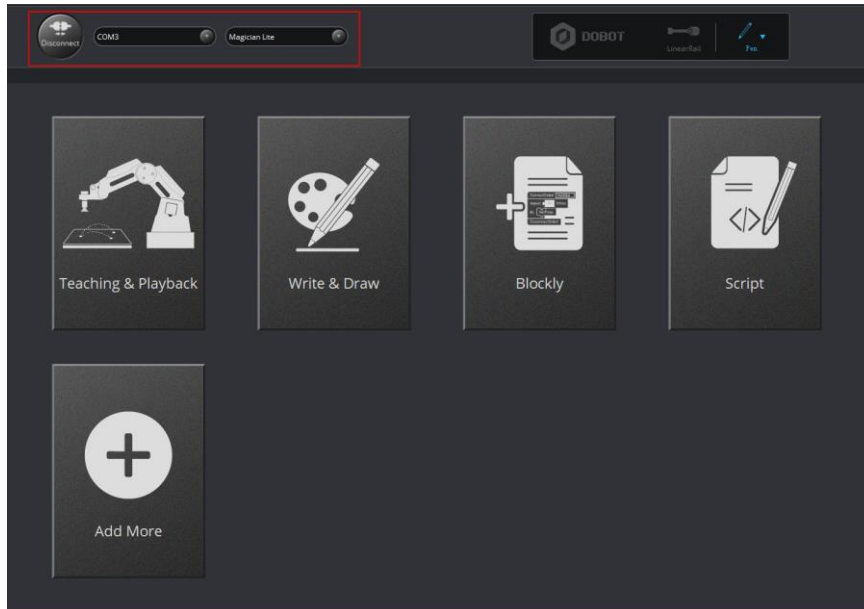

Figure 5.37 Connect Magician Lite

Step 2 Click **Write & Draw**, as shown in Figure 5.38.

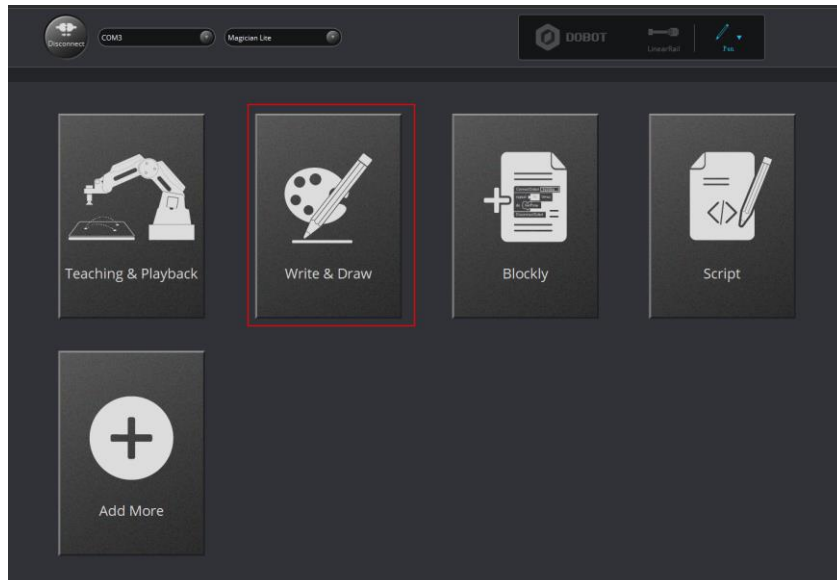

Figure 5.38 Click Write & Draw

Step 3 Choose **Pen** as the end-effector on the **Write & Draw** page, as shown in Figure 5.39.

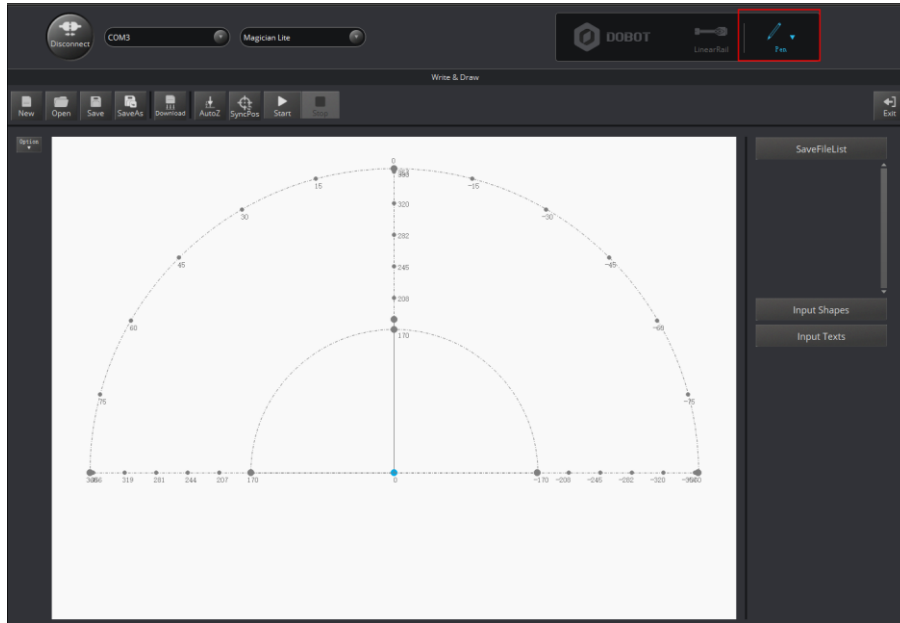

Figure 5.39 Choose Pen as the end-effector

5.5.3 Importing Image Files and Setting Writing Parameters

When performing a write & draw task, a built-in or custom image file is required. Only a PLT or SVG image can be used. The built-in file is located in the directory *Installation Directory* \DobotStudio\config\prefab\system\source.

Prerequisites

A PLT or SVG image file has been created.

Procedure

Step 1 Click **Write & Draw** on the **DobotStudio** page, as shown in Figure 5.40.

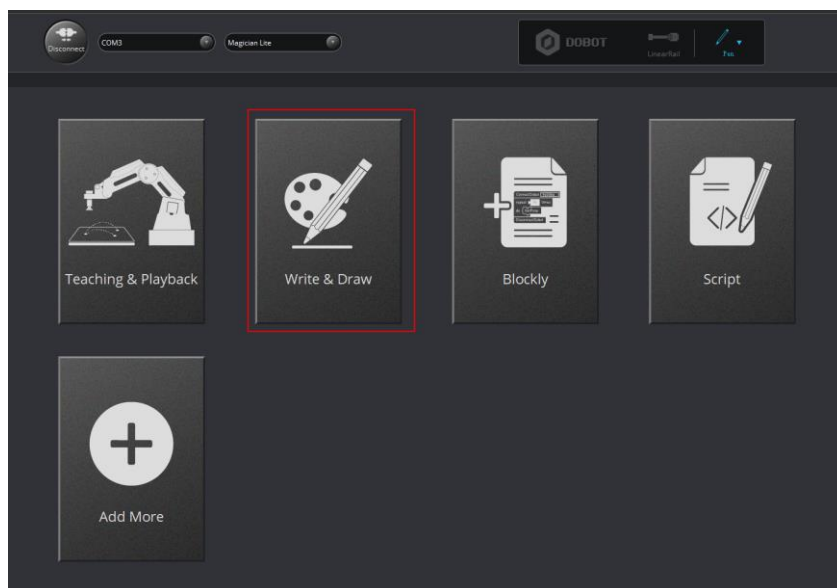

Figure 5.40 Click Write & Draw

Step 2 Import an image file using one of the following methods.

NOTICE

The imported image should be placed within the annular area on the **Write & Draw** page, as shown in Figure 5.41. If not, the robotic arm reaches its limited position and cannot draw or write. In this case, the image is highlighted with a red border, as shown in Figure 5.42.

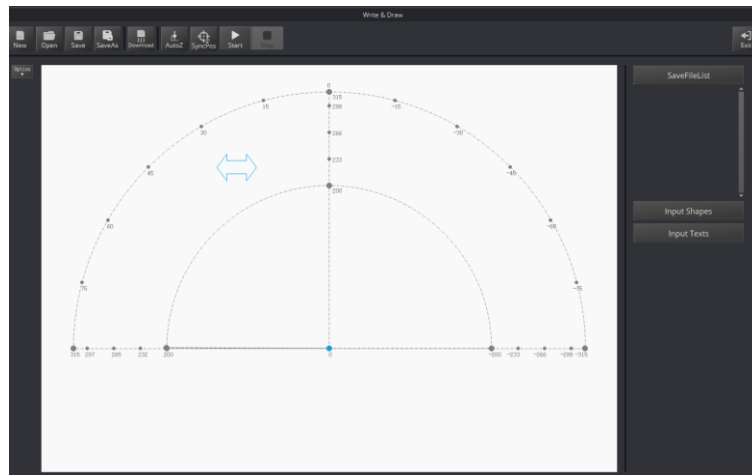

Figure 5.41 The PLT or SVG image is located within the annular area

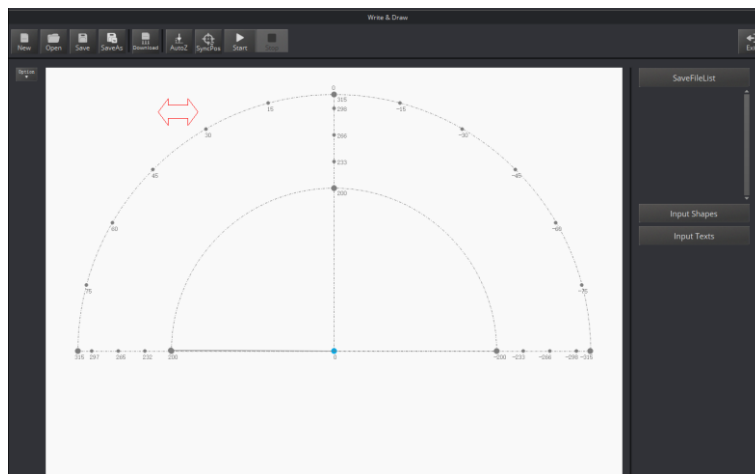

Figure 5.42 The PLT or SVG image is located outside the annular area

- Click **Open** on the **Write & Draw** page to import a built-in PLT or SVG image file from the DobotStudio installation directory *InstallationDirectory\DobotStudio\config\prefab\system\source*, as shown in Figure 5.43. You can also import your custom PLT or SVG image file.

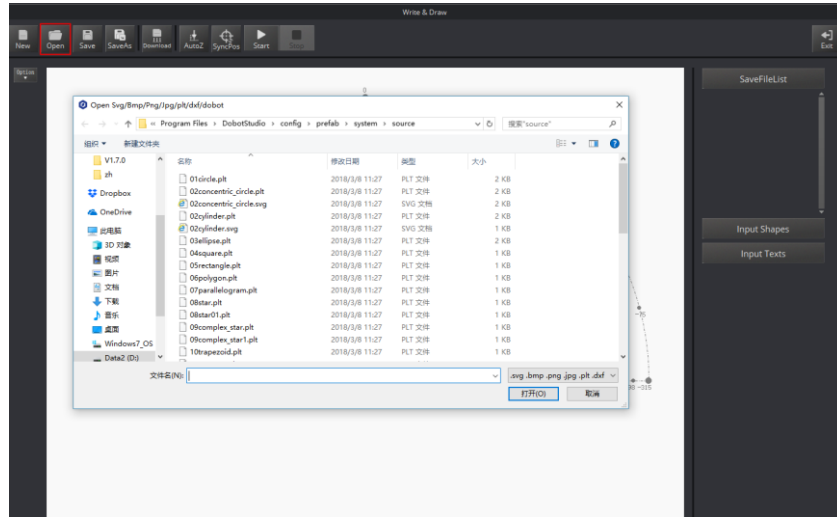

Figure 5.43 Open a PLT or SVG system image file

- Click a shape in the **Input Shapes** area, as shown in Figure 5.44.

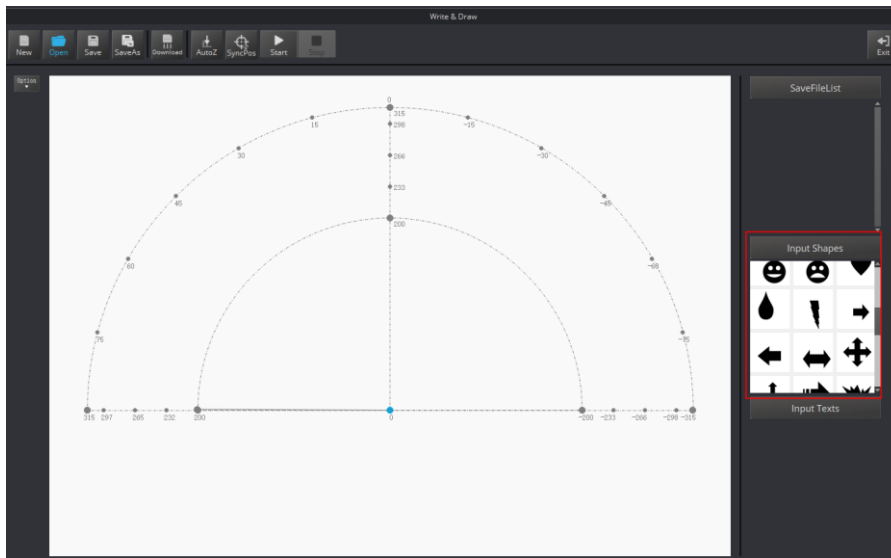

Figure 5.44 Insert a system image file

- Click **Input Texts** on the **Write & Draw** page to input texts, and set its style, and then click **OK** to display the text on the annular area, as shown in Figure 5.45.

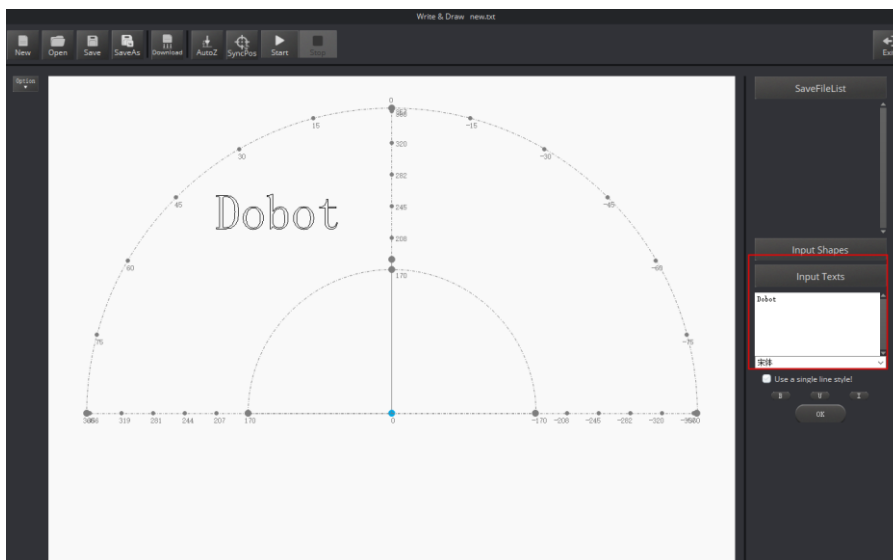

Figure 5.45 Input text

- Click **Open** to import an image file such as BMP, JPEG, or PNG to convert this image to its corresponding SVG file that the DobotStudio supports, as shown in Figure 5.46. Once this image is imported, the **SVG Converter** dialog box is displayed, as shown in Figure 5.47. In this dialog box, drag the slider to set the black and white threshold, and click **Convert Bitmap To SVG** to perform the conversion, and then click **Plot to Main Scene** to display the converted SVG file on the annular area of the **Write & Draw** page.

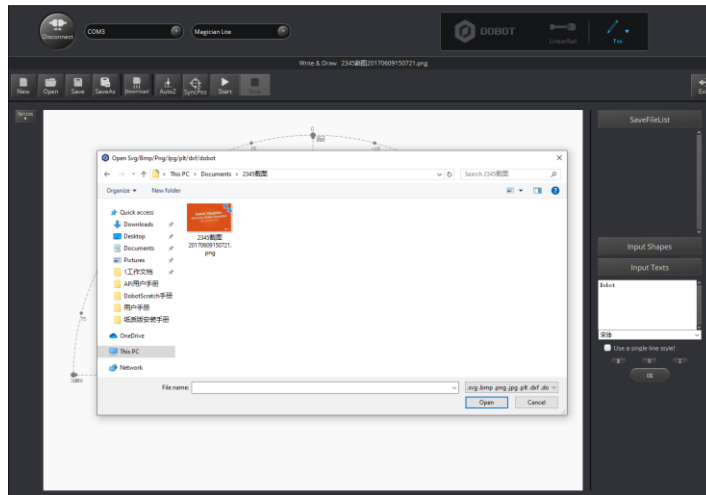

Figure 5.46 Import an image

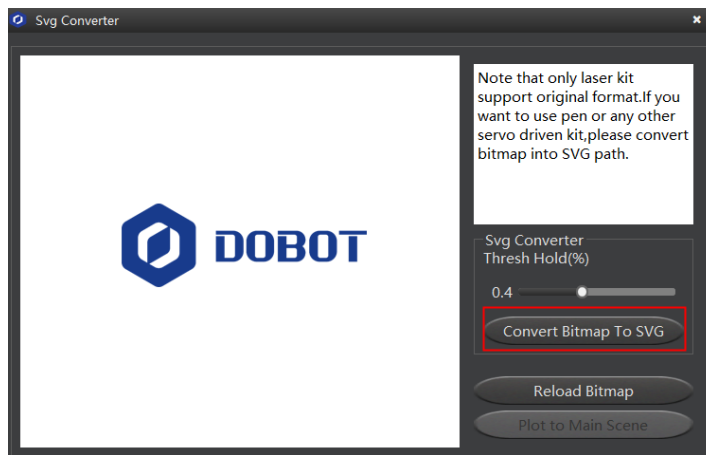

Figure 5.47 Convert an image to SVG

NOTICE

After image is converted to SVG, if there are single colors and fewer lines in the image, you need to adjust threshold, otherwise, the image can not be uploaded to DobotStudio.

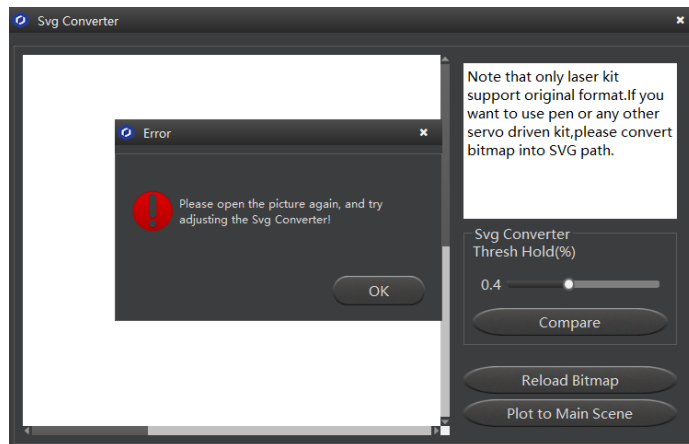

Figure 5.48 Error tip

Step 3 Set the writing parameters.

1. Click **Setting** on the **Write & Draw** page, as shown in Figure 5.49.

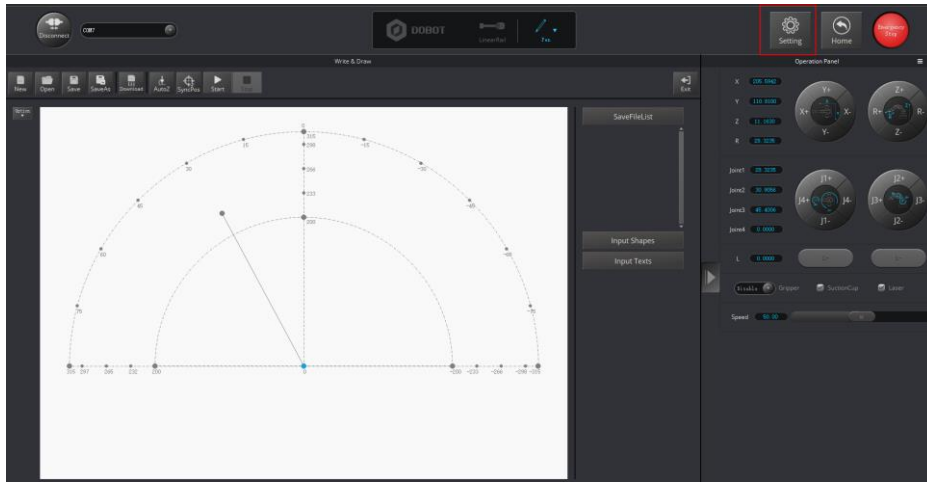

Figure 5.49 Click Setting

2. Click **Write & Draw** to set **ArmSpeedRatio** (%), **PenUpOffset** (mm), **PenDown** (mm), as shown in Figure 5.50.

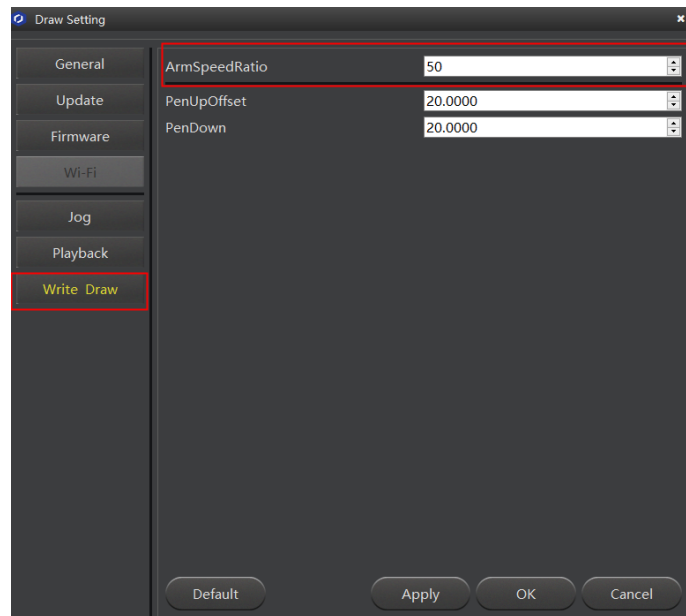

Figure 5.50 Setting the parameters of the Write & Draw function

5.5.4 Adjust the Position of the Pen Nib

Procedure

- Step 1** Raise and lower the position of the pen nib.

Press and hold the unlock button on the Forearm to move Magician Lite to raise and

lower the pen nib until it slightly squeezes the paper. You can also jog the robotic arm in the Cartesian or Joint coordinate system to slowly pull the Z axis down to a suitable vertical position for writing, as shown in Figure 5.51.



Figure 5.51 Adjust the position of the pen nib

NOTE

The point marked by a red box, as shown in Figure 5.52, corresponds to the position of the writing and drawing kit of Magician Lite. This point changes its position only within the annular area when the robotic arm moves.

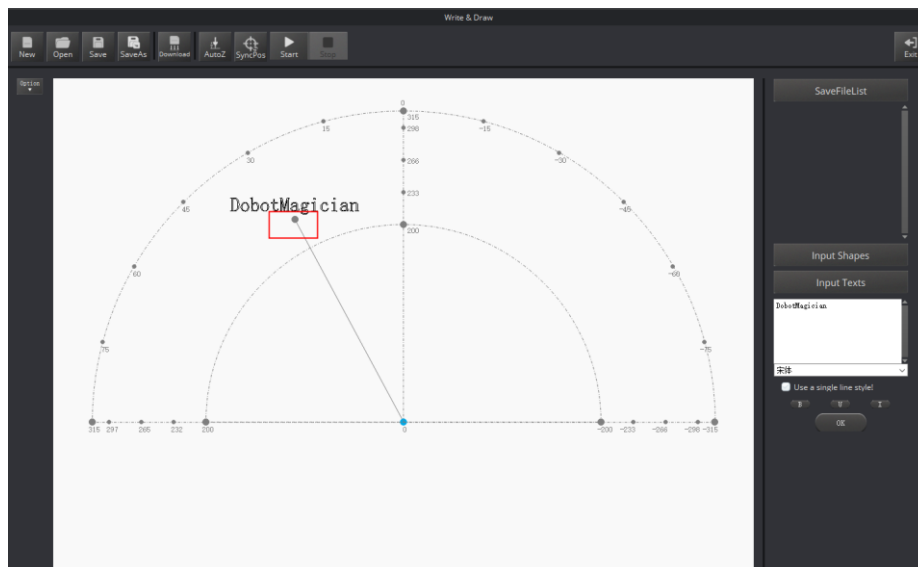

Figure 5.52 The point corresponding to the laser kit of the robotic arm

Step 2 Click **AutoZ** on the **Write & Draw** page to obtain and save the current value of the Z axis.

Once this step is complete, the next time you start to write, directly import a PLT or SVG image file without adjusting the position of the pen nib, and click **SyncPos**, and then click **Start** to start writing on the paper, as shown in Figure 5.53.

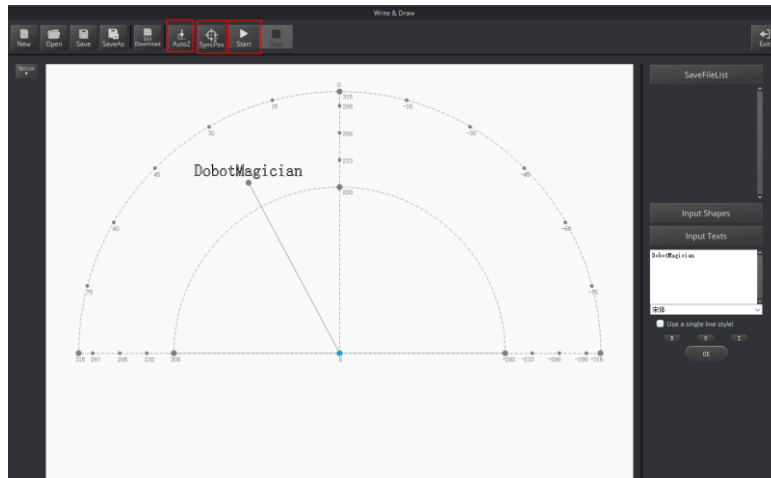

Figure 5.53 Lock the height of writing

NOTE

The value of the Z axis is the **PenDown** parameter. This parameter can be set by selecting **Setting > Write Draw > PenDown** on the **Write & Draw** page, as shown in Figure 5.54. If the effect of writing is not satisfactory, slightly raise and lower the height of the writing and drawing kit or directly change the value of **PenDown**.

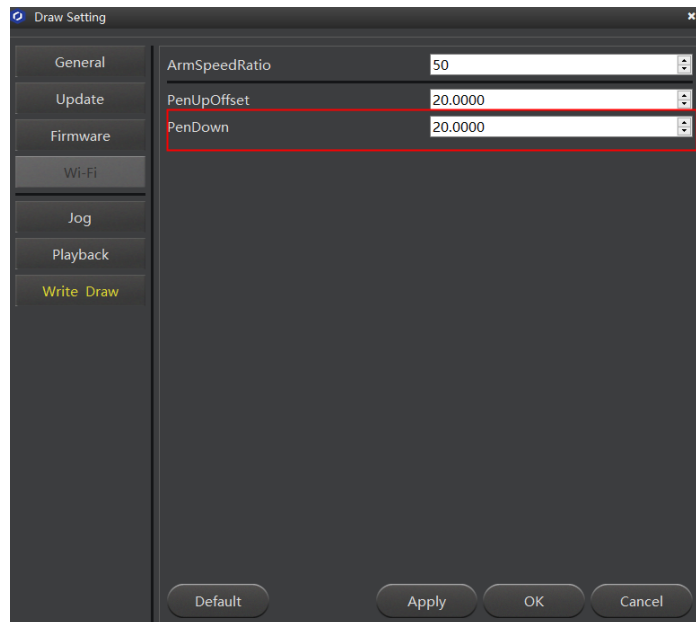

Figure 5.54 The PenDown parameter

Step 3 Click **SyncPos**.

Magician Lite automatically moves above the position (**PenDown**) of the start point

of the text.

Step 4 Click **Start** to start writing on the paper.

When writing, click **Pause** to pause the writing and **Stop** to halt the writing.

NOTE

You can click **Download** to download the file to Magic Box or Magician Lite to perform in offline mode. For the detail, please refer to 5.4 Working in Offline Mode

5.6 Operating Blockly

Blockly is a programming platform for Magician Lite based on Google Blockly. You can program through the puzzle format, which is straightforward and easy to understand.

Prerequisites

- Magic Box + Magician Lite has been powered on.
- Magic Box + Magician Lite has been connected to DobotStudio successfully.

Procedure

Step 1 Click **Blockly** on the DobotStudio page.

The **Blockly** page is displayed.

Step 2 Drag the blockly module on the left pane of the **Blockly** page to program, as shown in Figure 5.55.

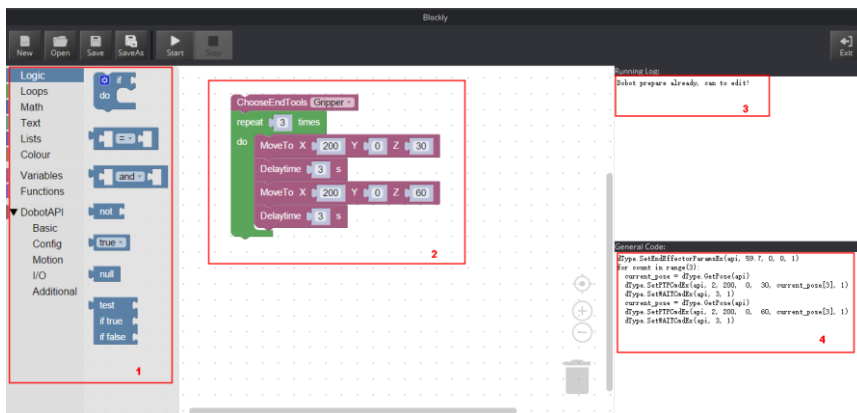

Figure 5.55 Blockly graphics programming

Table 5.11 lists the description of blockly module.

Table 5.11 Blockly description

No.	Description
1	The selection area of blockly module, including logistic, loop, math, and Dobot API. You can program by dragging them to the window
2	The window of blockly programming

No.	Description
3	The running log of Magician Lite
4	The corresponding codes of the blockly module on the programming window

The demo in Figure 5.55 is described as follows.

1. Set the end-effector as **Gripper**.
2. Set the loop number as 3 and make the Z-axis move back and forth 3 times.
3. Set the pause time as 3.

Step 3 Click **Save** on the **Blockly** page.

The Saving Blockly file page is displayed.

Step 4 Input the user-defined name and the saving path, and click **Save**. The default path of the programming file is *Installation directory/DobotStudio/config/bystore*. Please replace the path based on site requirements.

Step 5 Click **Start** on the **Blockly** page, and Magician Lite will move according to the program.

NOTE

You can also click **Download** to download Blockly file to Magic Box to perform in offline mode, for the details, please refer to 5.4 Working in Offline Mode.

5.7 Scripting

You can control Magician Lite over scripting. Magic Box supports various API, such as velocity setting, motion mode setting, and I/O configuration, which can be called by users during secondary development

The download path is https://www.dobot.cc/downloadcenter/dobot-magician-lite.html?sub_cat=187#sub-download.

Prerequisites

- Magic Box + Magician Lite has been powered on.
- Magic Box + Magician Lite has been connected to DobotStudio successfully.

Procedure

Step 1 Click **Script** on the **DobotStudio** page.

The **Script** page is displayed.

Step 2 Write a script.

You can call the interface by double-clicking on the left pane of the **Script** page, the corresponding interface will be displayed on the middle pane, as shown in Figure

5.56. You can also click  icon on the corresponding interface to view the way

how to set the parameters. The scripting examples (including Jog, PTP) can refer to *Installation directory/DobotStudio/config/ststore/*.

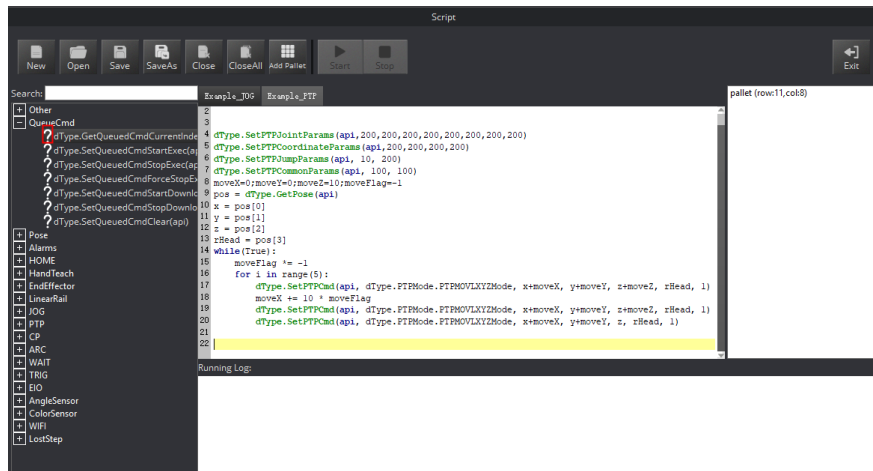

Figure 5.56 Write a script

Step 3 Click **Save** on the **Script** page.

The Saving Scrip File page is displayed.

Step 4 Input the user-defined name and the saving path, and click **Save**.

The default path of the script is *Installation directory/DobotStudio/config/ststore*. Please replace the path based on site requirements.

Step 5 Click **Start**, and Magician Lite will move according to the script file.

The running log will be displayed on the lower pane of the **Script** page for checking.



DOBOT

Shenzhen Yuejiang Technology Co., Ltd

www.dobot.cc