

FLEX I/O Dual Port EtherNet/IP Adapter Modules

Catalog Numbers 1794-AENTR, 1794-AENTRXT

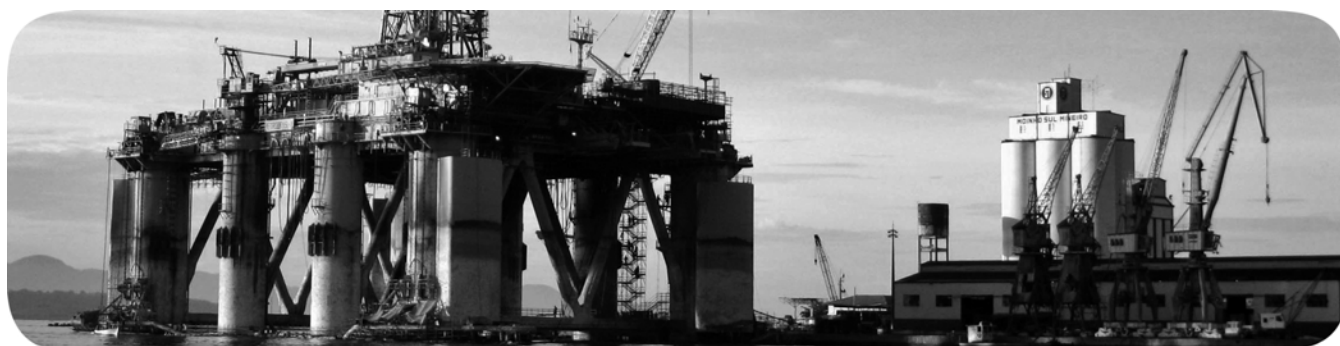

Important User Information

Solid-state equipment has operational characteristics differing from those of electromechanical equipment. Safety Guidelines for the Application, Installation and Maintenance of Solid State Controls (publication [SGL-1.1](#) available from your local Rockwell Automation sales office or online at <http://www.rockwellautomation.com/literature/>) describes some important differences between solid-state equipment and hard-wired electromechanical devices. Because of this difference, and also because of the wide variety of uses for solid-state equipment, all persons responsible for applying this equipment must satisfy themselves that each intended application of this equipment is acceptable.

In no event will Rockwell Automation, Inc. be responsible or liable for indirect or consequential damages resulting from the use or application of this equipment.

The examples and diagrams in this manual are included solely for illustrative purposes. Because of the many variables and requirements associated with any particular installation, Rockwell Automation, Inc. cannot assume responsibility or liability for actual use based on the examples and diagrams.

No patent liability is assumed by Rockwell Automation, Inc. with respect to use of information, circuits, equipment, or software described in this manual.

Reproduction of the contents of this manual, in whole or in part, without written permission of Rockwell Automation, Inc., is prohibited.

Throughout this manual, when necessary, we use notes to make you aware of safety considerations.



WARNING: Identifies information about practices or circumstances that can cause an explosion in a hazardous environment, which may lead to personal injury or death, property damage, or economic loss.



ATTENTION: Identifies information about practices or circumstances that can lead to personal injury or death, property damage, or economic loss. Attentions help you identify a hazard, avoid a hazard, and recognize the consequence



SHOCK HAZARD: Labels may be on or inside the equipment, for example, a drive or motor, to alert people that dangerous voltage may be present.



BURN HAZARD: Labels may be on or inside the equipment, for example, a drive or motor, to alert people that surfaces may reach dangerous temperatures.

IMPORTANT Identifies information that is critical for successful application and understanding of the product.

Allen-Bradley, Rockwell Automation, FLEX I/O, ControlLogix, RSLogix, RSLinx, and TechConnect are trademarks of Rockwell Automation, Inc.

Trademarks not belonging to Rockwell Automation are property of their respective companies.

Read this preface to familiarize yourself with the rest of the manual. It provides information concerning:

- who should use this manual
- the purpose of this manual
- related documentation
- conventions used in this manual

Who Should Use this Manual

This manual is intended for control engineers and technicians who are installing, configuring, and maintaining a redundant EtherNet/IP control system that communicates with FLEX I/O through a 1794-AENTR or 1794-AENTRXT adapter.

We assume you have a good understanding of Ethernet and the TCP/IP protocol. If you do not, refer to your software user manuals or online help before attempting to use these modules.

Purpose of this Manual

This manual describes how you can use your FLEX I/O EtherNet/IP adapter with your controller. The manual helps you install, program, and troubleshoot your module.

For Information About	See
Overview of FLEX I/O and Your Redundant EtherNet/IP Adapter Module	Chapter 1
Install Your FLEX I/O Adapter	Chapter 2
Configure the Adapter for Your EtherNet/IP Network	Chapter 3
Rack Optimized Discrete I/O	Chapter 4
Analog I/O with Direct Connection	Chapter 5
Interpret Status Indicators	Appendix A
Configure the RSLinx Ethernet Communication Driver	Appendix B
Adapter Web Dialogs	Appendix C

Related Documentation

The following documents contain additional information concerning Rockwell Automation products.

Resource	Description
FLEX I/O Selection Guide, publication 1794-SG002	A description and overview of the 1794 series FLEX I/O, FLEX I/O XT and FLEX Ex modules and compatible control platforms.
FLEX I/O Dual Port EtherNet/IP Adapter Modules, publication 1794-IN131	Information on how to install the FLEX I/O redundant EtherNet/IP adapter modules Catalog No. 1794-AENTR, 1794-AENTRXT
1794 FLEX I/O Communication Adapters Specifications Technical Data Sheet, publication 1794-TD014	Technical specifications and certifications for FLEX I/O communication adapters
ControlLogix System User Manual, publication 1756-UM001	Detailed information on how to install, configure and troubleshoot the ControlLogix Sequence of Events module in your ControlLogix application.
FLEX I/O DC Power Supply Installation Instructions, publication 1794-IN069	Information on how to install the FLEX I/O DC Power Supply Catalog No. 1794-PS13, 1794-PS3
EtherNet/IP Embedded Switch Technology Application Guide, publication ENET-AP005	Information on how to install, configure and maintain linear and Device-level Ring (DLR) networks using Rockwell Automation EtherNet/IP devices with embedded switch technology.
EtherNet/IP Modules in Logix5000 Control Systems User Manual, publication ENET-UM001	Detailed information on how to use EtherNet/IP modules with Logix5000 controllers and communicate with various devices on the Ethernet network.
Interconnect Cable Installation Instructions, publication 1794-5.12	Information on how to install the extension cables. Catalog No. 1794-CE1, 1794-CE3
Industrial Automation Wiring and Grounding Guidelines, publication 1770-4.1	In-depth information on grounding and wiring Allen-Bradley programmable controllers.
Allen-Bradley Industrial Automation Glossary, publication AG-7.1	A glossary of industrial automation terms and abbreviations.

You can view or download publications at <http://www.rockwellautomation.com/literature/>. To order paper copies of technical documentation, contact your local Rockwell Automation distributor or sales representative.

Common Techniques Used in this Manual

The following conventions are used throughout this manual:

- Bulleted lists such as this one provide information, not procedural steps.
- Numbered lists provide sequential steps or hierarchical information.
- *Italic* type is used for emphasis.

Preface

Who Should Use this Manual iii
 Purpose of this Manual iii
 Related Documentation iv
 Common Techniques Used in this Manual iv

Table of Contents

Overview of FLEX I/O and Your Redundant EtherNet/IP Adapter Module

Chapter 1

Overview 1
 The FLEX I/O System 1
 Adapter Features 2
 Types of Adapters 2
 Hardware and Software Compatibility 2
 What the Adapter Does 3
 Use of the Control and Information Protocol (CIP) 3
 Understanding the Producer/Consumer Model 3
 Specifying the Requested Packet Interval (RPI) 4
 Support of Rack Optimized and Direct Connections 4
 Mixing Rack Optimized and Direct Connections 5
 Chapter Summary 5

Install Your FLEX I/O Adapter

Chapter 2

Overview 7
 Module Components 7
 Mount Your Adapter on a DIN Rail 8
 Mount on a Panel or Wall 9
 Connect Wiring 11
 Set the Network Address 12
 Mounting Dimensions 13

Configure the Adapter for Your EtherNet/IP Network

Chapter 3

Overview 15
 Configuration Requirements 15
 IP Address 15
 Gateway Address 16
 Subnet Mask 17
 Use the Rockwell BootP/DHCP Utility 18
 Save the Relation List 21
 Configure Your Adapter using DHCP Software 21
 Chapter Summary 22

Rack Optimized Discrete I/O	Chapter 4	
	Overview	23
	Set Up the Hardware	23
	Create the Example Application	24
	Configure the I/O.....	26
	Add the Local EtherNet/IP Bridge to the I/O Configuration	26
	Add the FLEX I/O Adapter to the I/O Configuration.....	27
	Add the FLEX I/O Modules to the I/O Configuration	29
	Create the Ladder Program.....	34
	Download the Program to the Controller.....	34
	Test the Example Application	35
	Chapter Summary.....	36
Analog I/O with Direct Connection	Chapter 5	
	Overview	37
	Set Up the Hardware	37
	Create the Example Application	38
	Add the Analog Modules to the I/O Configuration	39
	Add the Analog Input Module to the I/O Configuration	39
	Add the Analog Output Module to the I/O Configuration.....	42
	Edit the Controller Tags	45
	Modify the Ladder Program	47
	Download the Program	47
	Test the Example Application	48
	Chapter Summary.....	49
Interpret Status Indicators	Appendix A	
	Overview	51
	Status Indicators	51
	1794-AENTR, 1794-AENTRXT Module.....	51
	Chapter Summary.....	52
Configure the RSLinx Ethernet Communication Driver	Appendix B	
	Overview	53
	About the Ethernet Communication Driver.....	53
	Install the RSLinx Software	53
	Configure the AB_ETH Driver	53
Adapter Web Dialogs	Appendix C	
	Overview	57
	Work with the Home Page.....	57
	Work with the Diagnostics Pages	59
	Use the Diagnostic Overview Page	60
	Use the Network Settings Page	61

Use the Ethernet Statistics Page.....	62
Use the I/O Connections Page.....	63
Work with the Configuration Pages	64
Use the Device Identity Page	65
Use the Network Configuration Page	66
Use the Device Services Page.....	68

Index

Overview of FLEX I/O and Your Redundant EtherNet/IP Adapter Module

Overview

This chapter provides a description of the FLEX I/O dual port EtherNet/IP adapter modules and an overview of how they communicate with programmable controllers.

Topic	Page
The FLEX I/O System	1
Adapter Features	2
Types of Adapters	2
Hardware and Software Compatibility	2
What the Adapter Does	3
Use of the Control and Information Protocol (CIP)	3
Understanding the Producer/Consumer Model	3
Specifying the Requested Packet Interval (RPI)	4
Support of Rack Optimized and Direct Connections	4

The FLEX I/O System

The FLEX I/O system is a small, modular I/O system for distributed applications that performs all of the functions of rack-based I/O. The FLEX I/O system contains the following components:

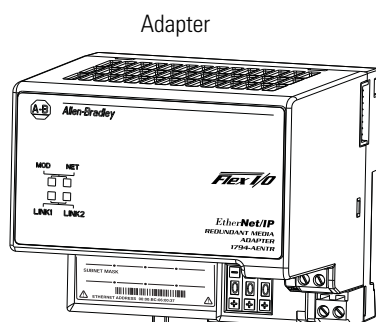

45821

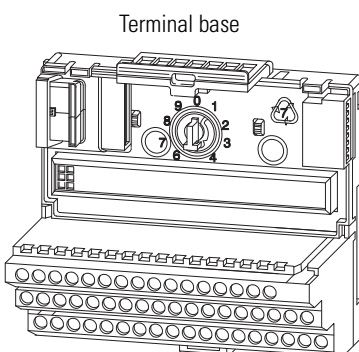

1112

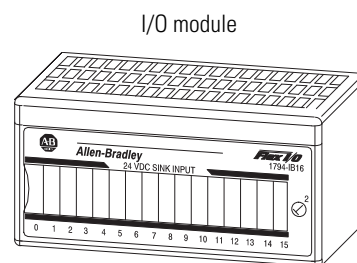

1113

- Adapter – transfers read and write configuration data to and from the I/O module
- Terminal base – contains a terminal strip to terminate wiring for two- or three-wire devices
- I/O module – contains the bus interface and circuitry needed to perform specific functions related to your application

The FLEX system consists of an adapter module, terminal base unit, DIN rail, power supply, and adapter cabling components. You can use up to 8 terminal bases per adapter module.

For detailed instructions on how to set up and install your module, refer to the topic, *Install Your FLEX I/O Adapter* on page 7.

Adapter Features

The 1794-AENTR and 1794-AENTRXT adapter features include:

- use of EtherNet/IP messages encapsulated within standard TCP/UDP/IP protocol
- common application layer with ControlNet and DeviceNet
- interfacing via Category 5 rated twisted pair cable
- half/full duplex 10 Mbit or 100 Mbit operation
- DIN rail mounting
- communication to and from other FLEX I/O modules on the same DIN rail
- communication supported by RSLinx software
- IP address assigned via standard BootP/DHCP tools
- I/O configuration via RSLogix 5000 software
- no network scheduling required
- no routing tables required

Types of Adapters

The adapter refers to the following catalogs.

Catalog	Voltage	Module Capacity	Description
1794-AENTR	24V DC	8, max.	Dual port EtherNet/IP adapter
1794-AENTRXT	24V DC	8, max.	Dual port EtherNet/IP adapter with extended temperatures range

Hardware and Software Compatibility

The adapters and the applications described in this manual are compatible with the following firmware versions and software releases. Contact Rockwell Automation if you need software or firmware upgrades to use this equipment.

Hardware and Software Compatibility

Product	Firmware Version/ Software Release
1794-AENTR/1794-AENTRXT adapter	1.xx or higher
Logix 557x Controller	20 or higher
RSLogix 5000 Software	20 or higher
RSLinx software	2.59 or higher

Refer to the 1794 FLEX I/O Communication Adapters Specifications Technical Data Sheet, publication [1794-TD014](#), for technical specifications and certifications for your adapter.

What the Adapter Does

The 1794-AENTR and 1794-AENTRXT adapters perform two primary tasks:

- Control of real time I/O data (implicit messaging). The adapter serves as a bridge between I/O modules and the network.

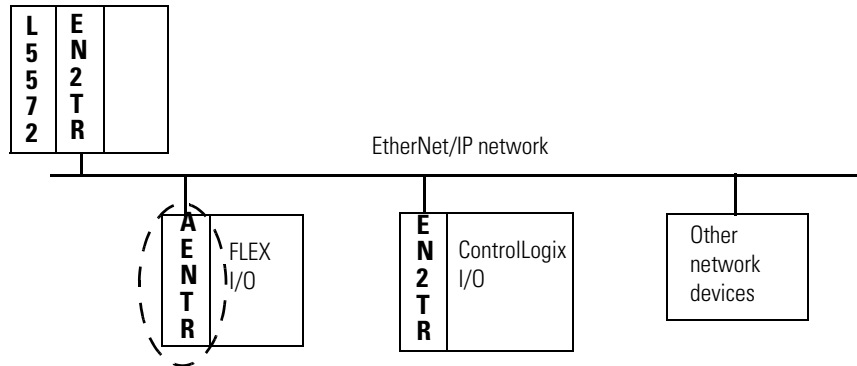

- Support of messaging data for configuration and programming information (explicit messaging).

Use of the Control and Information Protocol (CIP)

The 1794-AENTR and 1794-AENTRXT adapters use the Control and Information Protocol (CIP). CIP is the application layer protocol specified for EtherNet/IP, the Ethernet Industrial Protocol, as well as for ControlNet and DeviceNet. It is a message-based protocol that implements a relative path to send a message from the producing device in a system to the consuming devices.

The producing device contains the path information that steers the message along the proper route to reach its consumers. Since the producing device holds this information, other devices along the path simply pass this information; they do not need to store it.

This has two significant benefits:

- You do not need to configure routing tables in the bridging modules, which greatly simplifies maintenance and module replacement.
- You maintain full control over the route taken by each message, which enables you to select alternative paths for the same end device.

Understanding the Producer/Consumer Model

The CIP producer/consumer networking model replaces the old source/destination (master/slave) model. The producer/consumer model reduces network traffic and increases speed of transmission. In traditional I/O systems, controllers poll input modules to obtain their input status. In the CIP system input modules are not polled by a controller. Instead, they produce

(multicast) their data either upon a change of state (COS) or periodically. The frequency of update depends upon the options chosen during configuration and where on the network the input module resides. The input module, therefore, is a producer of input data and the controller is a consumer of the data.

The controller can also produce data for other controllers to consume. The produced and consumed data is accessible by multiple controllers over the EtherNet/IP network. This data exchange conforms to the producer/consumer model.

Specifying the Requested Packet Interval (RPI)

The RPI is the update rate specified for a particular piece of data on the network. The RPI can be specified for the adapter and include all of the I/O modules communicating through it (using a rack optimized connection) or specified for a particular module (using direct connection). When you add a module or an adapter to the I/O configuration of a controller, you must enter the RPI as a parameter. This value specifies how often to produce the data for that device. For example, if you specify an RPI of 50 ms, it means that every 50ms the device should send its data to the controller or the controller should send its data to the device.

RPIs are only used for devices that produce data. For example, a ControlLogix EtherNet/IP bridge module in the same chassis as the controller does not require an RPI because it is not a data-producing member of the system; it is used only as a bridge to remote racks.

Support of Rack Optimized and Direct Connections

The 1794-AENTR and 1794-AENTRXT adapters support both direct and rack optimized connections. A direct connection is a real-time data transfer link between the controller and the device that the configuration data references. Direct connection messaging occurs at a cyclic rate specified by the RPI during configuration. A rack optimized connection is a grouping of data from more than one I/O module into a single block of data sent over a single connection at the same data rate.

Rack optimized connections reduce the total number of connections needed to transfer data when using many I/O modules in a system. The following example illustrates the benefit of rack optimized connections.

Assume you have set up a system that contains 8 discrete I/O modules interfaced to an adapter. If you use direct connections to transfer data to each of these I/O modules, you need 8 connections to transfer all of the data, one to each of

the 8 I/O modules. If you use a rack-optimized connection to transfer the data, you only need a single connection – the connection to the adapter.

IMPORTANT

Although rack optimized connections offer an efficient way to use resources, there are a few limitations on their use:

- You can only use rack optimized connections to send data to and from discrete I/O modules. Analog I/O requires direct connections.
 - Rack optimized connections can contain I/O data and status information only. Additional module information, such as diagnostics, is not available through a rack-optimized connection.
 - All data is sent at the same time at the RPI rate of the adapter.
-

Refer to the EtherNet/IP Embedded Switch Technology Application Guide, publication number [ENET-AP005](#), for more information on connections.

Mixing Rack Optimized and Direct Connections

You can mix communication formats for different I/O modules communicating through the same adapter. I/O modules set up to use rack optimization will communicate at the rate of the requested packet interval (RPI) configured for the 1794-AENTR or 1794-AENTRXT adapter. I/O modules configured for direct communication will communicate at their own set RPIs and ignore the adapter RPI.

Chapter Summary

This chapter briefly described the FLEX I/O system, the FLEX I/O dual port EtherNet/IP adapters, and the basic adapter features. Read the next chapter to learn how to physically install the adapters and connect them to the EtherNet/IP network.

Notes:

Install Your FLEX I/O Adapter

Overview

This chapter describes how to physically install the 1794-AENTR or 1794-AENTRXT adapter on the DIN rail and connect it to the EtherNet/IP network. The following table lists where to find specific information.

Topic	Page
Module Components	7
Mount Your Adapter on a DIN Rail	8
Mount on a Panel or Wall	9
Connect Wiring	11
Set the Network Address	12
Mounting Dimensions	13

Module Components

Use the following illustration to identify the external features of the FLEX I/O EtherNet/IP adapter.

Dual Port EtherNet/IP Adapter – 1794-AENTR, 1794-AENTRXT

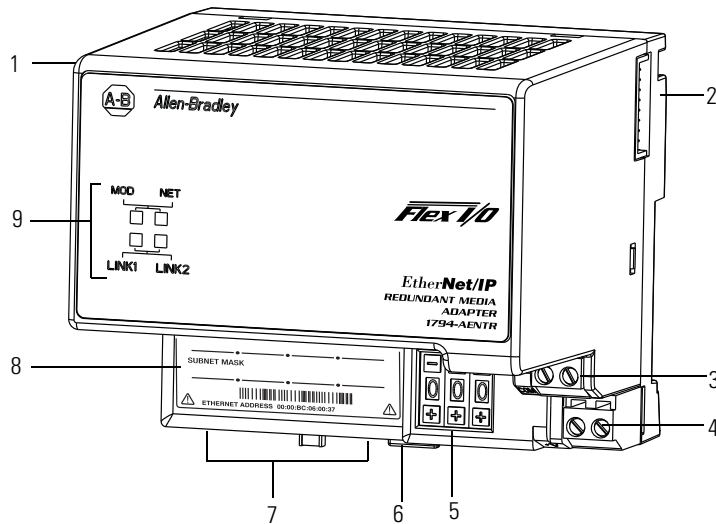

45821

Component Identification

1	Dual Port EtherNet/IP adapter	6	Module locking tab
2	FlexBus connector	7	Network cable RJ45 connectors (underside)
3	24V common connections	8	MAC ID label
4	24V DC connections	9	Status indicators
5	IP address switches		

Mount Your Adapter on a DIN Rail

Follow these steps to mount the adapter on a new system before installing any I/O modules.

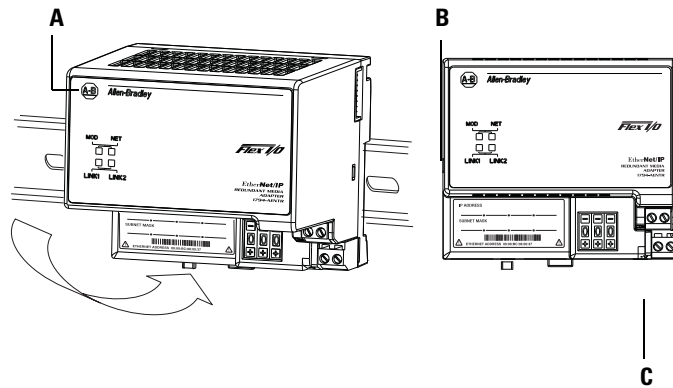

45822



ATTENTION: During mounting of all devices, be sure that all debris (for example, metal chips, wire strands) is kept from falling into the module. Debris that falls into the module could cause damage on power up.



ATTENTION: Do not remove or replace an Adapter Module while power is applied. Interruption of the backplane can result in unintentional operation or machine motion.

1. Position the adapter module (A) on an IEC standard (35 x 7.5 x 1 mm) top-hat DIN rail (B) at a slight angle (DIN rail: Allen-Bradley part number 199-DR1; 46277-3; EN50022).
2. Hook the lip on the rear of the adapter onto the top of the DIN rail, and pivot the adapter module onto the rail.
3. Press the adapter module down onto the DIN rail until flush. Locking tab (C) snaps the adapter into position and locks it onto the DIN rail.
4. If the adapter module does not lock in place, use a screwdriver or similar device to move the locking tab down while pressing the adapter module flush onto the DIN rail, and release the locking tab to lock the adapter module in place.
If necessary, push up on the locking tab to lock.
5. Connect the adapter wiring as shown in the Connect Wiring diagram.

Mount on a Panel or Wall

If mounting this adapter to a panel or wall, refer to publication [1794-TD013](#), Panel Mounting Kit, Cat. No. 1794-NM1.



ATTENTION: If you insert or remove the module while backplane power is on, an electrical arc can occur. This could cause an explosion in hazardous location installations. Be sure that power is removed or the area is nonhazardous before proceeding.



WARNING: When used in a Class I, Division 2, hazardous location, this equipment must be mounted in a suitable enclosure with proper wiring method that complies with the governing electrical codes.

Mount or Replace the Adapter on an Existing System

1. Disconnect any wiring jumpered to the adjacent terminal base.
2. Remove the Ethernet connectors from the bottom of the adapter.



WARNING: If you connect or disconnect the communication cable with power applied to the adapter or any device on the network, an electrical arc can occur. This could cause an explosion in hazardous location installations. Be sure that power is removed or the area is nonhazardous before proceeding.

3. Disconnect any user power wiring connections to the adapter.
4. Open the module latching mechanism and remove the module from the base unit to which the adapter will be attached.
5. Push the FlexBus connector toward the right side of the terminal base to unplug the backplane connection.



ATTENTION: Make certain the FlexBus connector is completely clear of the adapter. The slide must be completely to the right and the raised spot on the slide visible.

6. Release the locking tab and remove the adapter module.

Before installing the new adapter, notice the notch on the right rear of the adapter. This notch accepts the hook on the terminal base unit. The notch is open at the bottom. The hook and adjacent connection point keep the

terminal base and the adapter tight together, reducing the possibility of a break in communication over the backplane.

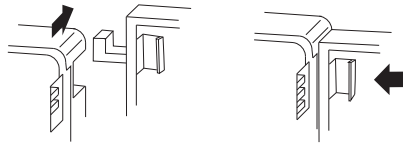

7. Complete the adapter mounting as shown below.

Push down and in at the same time to lock the adapter to the DIN rail.

If the adapter does not lock in place, use a screwdriver or similar device to move the locking tab down while pressing the adapter flush onto the DIN rail, and release the locking tab to lock the adapter module in place. If necessary, push up on the locking tab to lock.

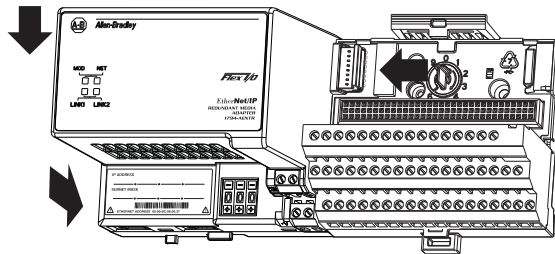

When the adapter is locked onto the DIN rail, gently push the FlexBus connector into the adapter to complete the backplane.

8. Reinstall the module in the adjacent terminal base unit.

Connect Wiring

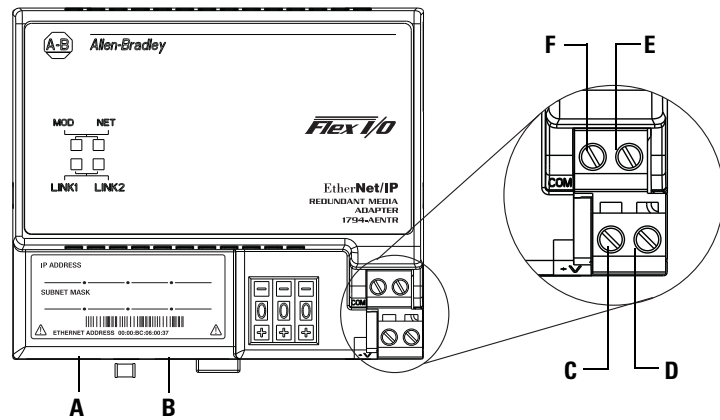

45823



WARNING: If you connect or disconnect wiring while the field-side power is on, an electrical arc can occur. This could cause an explosion in hazardous location installations. Be sure that power is removed or the area is nonhazardous before proceeding.

1. Connect an Ethernet network cable to the RJ45 connector (A).
2. Connect the redundant Ethernet network cable to the RJ45 connector (B).

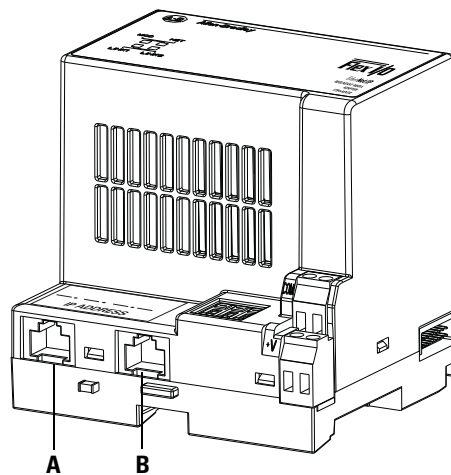

ATTENTION: When connecting wiring, torque terminal screws C, D, E and F to 0.8 Nm (7 lb-in.).

ATTENTION: If multiple power sources are used, do not exceed the specified isolation voltage.

ATTENTION: Power wiring must be less than 10 m (32.8 ft.) in length.

ATTENTION: Do not wire more than two conductors on any single terminal.

3. Connect 24V DC common to the left side of the upper connector, terminal F.
4. Connect +24V DC input power to the left side of the lower connector, terminal C.
5. Use connections D and E to pass +24V DC common (E) and 24V DC power (D) to the next module in the series (if required).

Set the Network Address

The adapter ships with the thumbwheel switches set to 999 and DHCP enabled. You can set the network Internet Protocol (IP) address in these ways:

- Use the thumbwheel switches on the module.
- Use a Dynamic Host Configuration Protocol (DHCP) server, such as Rockwell Automation DHCP.
- Retrieve the IP address (if previously set) from nonvolatile memory.

The adapter reads the thumbwheel switches first to determine if the switches are set to a valid number. You set the node address by using the three-position thumbwheel switch. Press the + or - buttons to change the number. Valid settings are 001...254.

When the switches are set to a valid number, the adapter IP address is 192.168.1.xxx (where xxx represents the number set on the switches). The adapter subnet mask is 255.255.255.0. The adapter gateway address is set differently depending on the firmware revision:

- For Firmware Revision 1.013 and earlier, when the address switches are set to 001...254, the adapter gateway address is set to 0.0.0.0.
- For Firmware Revision 1.014, when the address switches are set to 001, the adapter gateway address is set to 0.0.0.0. When the address switches are set to 002...254, the adapter gateway address is set to 192.168.1.1.

The adapter does not have a host name assigned, or use any Domain Name System when using the thumbwheel settings.

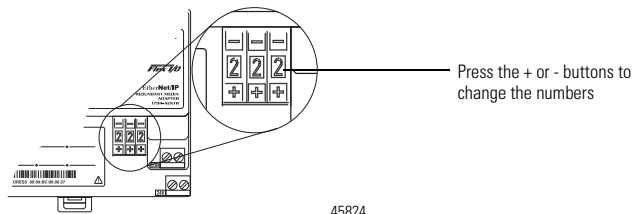

45824

If you set the switches to an invalid number (such as 000, or a value greater than 254), the adapter checks to see if you enabled DHCP.

Mounting Dimensions

The module has the following mounting dimensions.

1794-AENTR shown

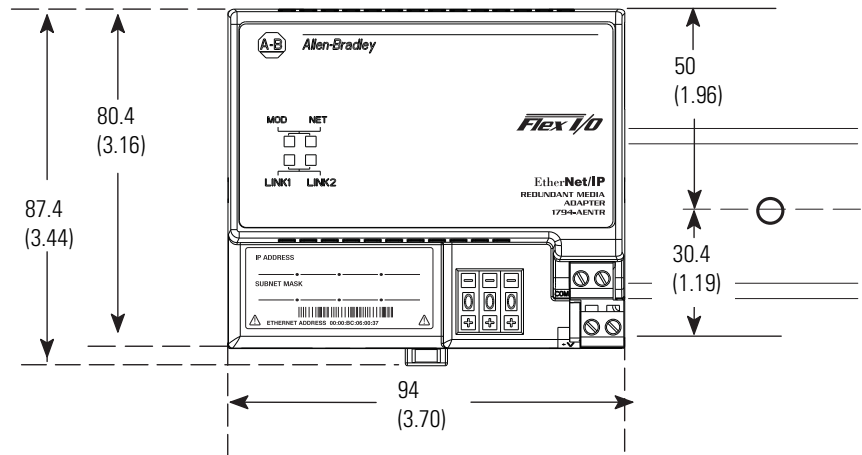

Millimeters
(Inches)

1794-AENTR, 1794-AENTRXT
87.4 H x 94W x 92D
(344H x 3.7W x 3.6D)

45826

Notes:

Configure the Adapter for Your EtherNet/IP Network

Overview

This chapter describes how to configure the 1794-AENTR or 1794-AENTRXT adapter module for the ControlLogix system.

Topic	Page
Configuration Requirements	15
IP Address	15
Gateway Address	16
Subnet Mask	17
Use the Rockwell BootP/DHCP Utility	18
Configure Your Adapter using DHCP Software	21

Configuration Requirements

Before you can use your 1794-AENTR or 1794-AENTRXT adapter, you must configure its IP address, and optionally, its subnet mask and gateway address. You can use the Rockwell BootP/DHCP utility to perform the configuration. You can also use generic BootP software or, within some limitations, a DHCP server.

IMPORTANT When using the BootP protocol, you must enter the Ethernet hardware address of your adapter. Rockwell assigns each 1794-AENTR or 1794-AENTRXT adapter a unique 48-bit hardware address at the factory. The address is printed on a label on the front of your 1794-AENTR or 1794-AENTRXT adapter. It consists of six hexadecimal digits separated by colons. This address is fixed by the hardware and cannot be changed.

If you change or replace the 1794-AENTR or 1794-AENTRXT adapter, you must enter the new Ethernet hardware address of the adapter when you configure the new adapter.

IP Address

The IP address identifies each node on the IP network (or system of connected networks). Each TCP/IP node on a network (including the 1794-AENTR or 1794-AENTRXT adapter) must have a unique IP address.

The IP address is 32 bits long and has a Net ID part and a Host ID part. Networks are classified A, B, C, (or other). The class of the network determines how an IP address is formatted.

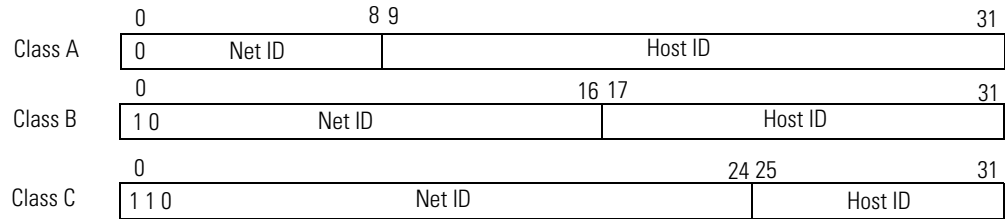

You can distinguish the class of the IP address from the first integer in its dotted-decimal IP address as follows:

Range of first integer	Class	Range of first integer	Class
0...127	A	192...223	C
128...191	B	224...255	other

Each node on the same physical network must have an IP address of the same class and must have the same Net ID. Each node on the same network must have a different Host ID thus giving it a unique IP address.

IP addresses are written as four decimal integers (0-255) separated by periods where each integer gives the value of one byte of the IP address.

EXAMPLE For example, the 32-bit IP address:
10000000 00000001 00000000 00000001 is written as
128.1.0.1.

TIP Contact your network administrator or the Network Information Center for a unique fixed IP address to assign to your module.

Gateway Address

The Gateway Address is the default address of a network. It provides a single domain name and point of entry to the site. Gateways connect individual physical networks into a system of networks. When a node needs to communicate with a node on another network, a gateway transfers the data between the two

networks. The following figure shows gateway G connecting Network 1 with Network 2.

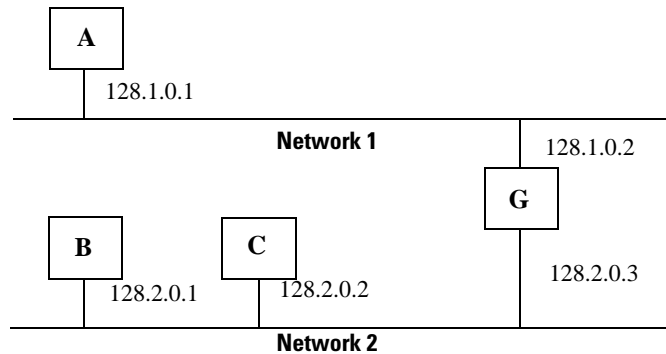

When host B with IP address 128.2.0.1 communicates with host C, it knows from C's IP address that C is on the same network. In an Ethernet environment, B then resolves C's IP address into a hardware address (MAC address) and communicates with C directly.

When host B communicates with host A, it knows from A's IP address that A is on another network (the net IDs are different). In order to send data to A, B must have the IP address of the gateway connecting the two networks. In this example, the gateway's IP address on Network 2 is 128.2.0.3.

The gateway has two IP addresses (128.1.0.2 and 128.2.0.3). The first must be used by hosts on Network 1 and the second must be used by hosts on Network 2. To be usable, a host's gateway must be addressed using a net ID matching its own.

Subnet Mask

The subnet mask is used for splitting IP networks into a series of subgroups, or subnets. The mask is a binary pattern that is matched up with the IP address to turn part of the Host ID address field into a field for subnets.

Take Network 2 (a Class B network) in the previous example and add another network. Selecting the following subnet mask would add two additional net ID bits, allowing for four logical networks:

EXAMPLE Take Network 2 (a Class B network) in the previous example and add another network. Selecting the following subnet mask would add two additional net ID bits, allowing for four logical networks:

11111111 11111111 **11**000000 00000001 = 255.255.192.0

These two bits of the host ID used to extend the net ID

Two bits of the Class B host ID have been used to extend the net ID. Each unique combination of bits in the part of the Host ID where subnet mask bits are 1 specifies a different logical network.

The new configuration is:

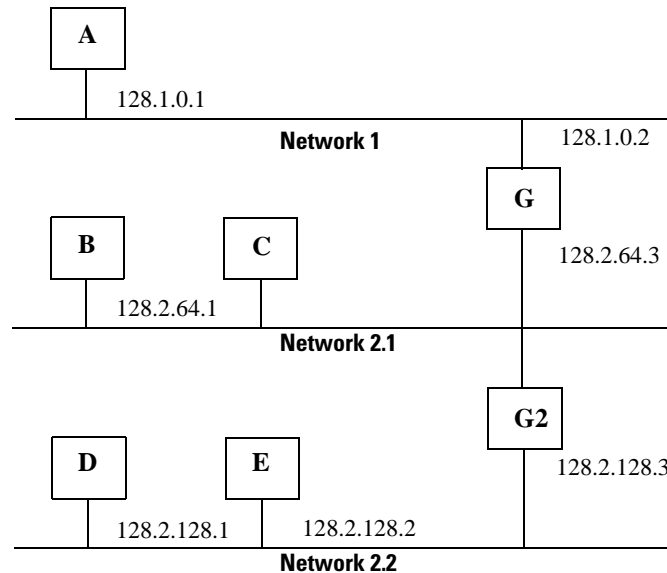

A second network with Hosts D and E was added. Gateway G2 connects Network 2.1 with Network 2.2.

Hosts D and E use Gateway G2 to communicate with hosts not on Network 2.2. Hosts B and C use Gateway G to communicate with hosts not on Network 2.1. When B is communicating with D, G (the configured gateway for B) routes the data from B to D through G2.

Use the Rockwell BootP/DHCP Utility

The Rockwell BootP/DHCP utility is a stand alone program that incorporates the functionality of standard BootP/DHCP software with a user-friendly graphical interface. It is located in the Utils directory on the RSLogix 5000 installation CD. The module must have DHCP enabled (factory default and the network address switches set to an illegal value) to use the utility.

To configure your module using the BootP/DHCP utility, perform the following steps:

1. Run the BootP/DHCP software.

The BOOTP/DHCP Request History dialog appears showing the hardware addresses of devices issuing BootP/DHCP requests.

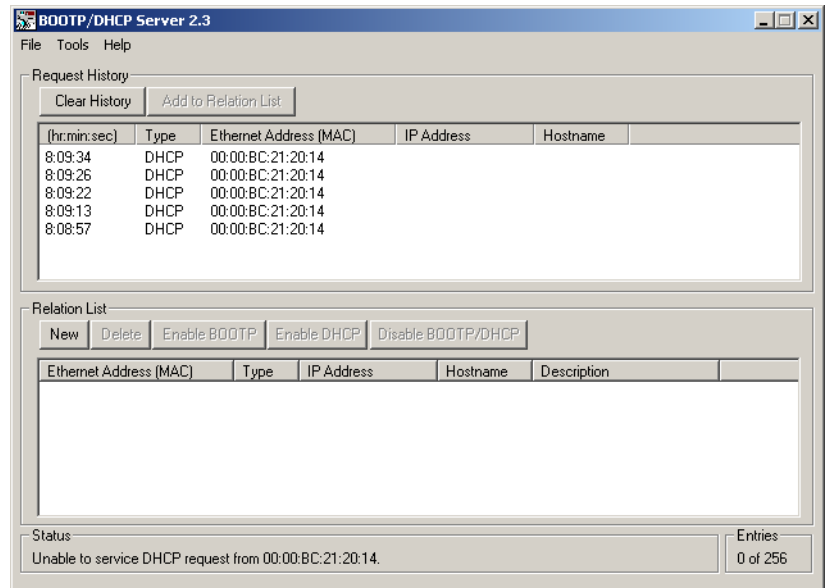

2. Double-click the hardware address of the device you want to configure.

The New Entry dialog appears showing the device's Ethernet Address (MAC).

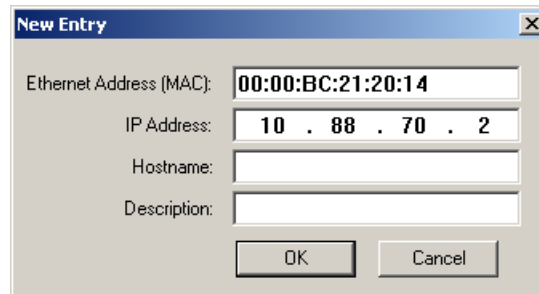

3. Enter the IP Address you want to assign to the device and click OK.

The device is added to the Relation List, displaying the Ethernet Address (MAC) and corresponding IP Address, Hostname and Description (if applicable).

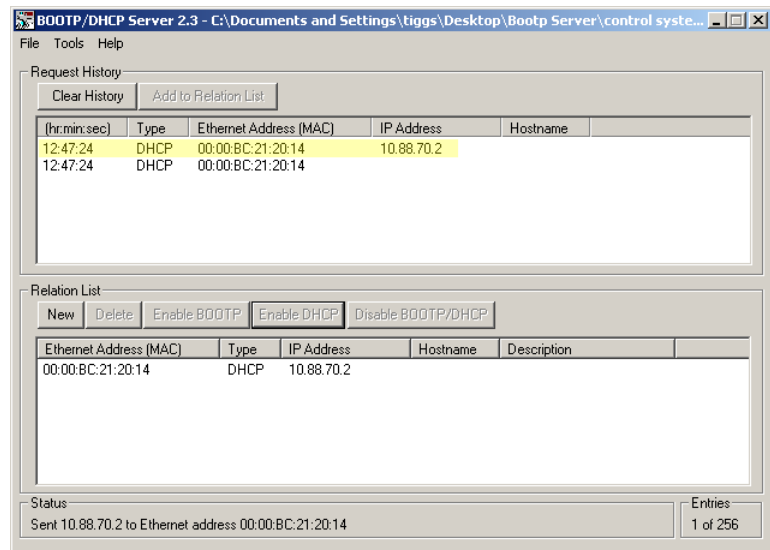

When the IP address assignment is made, the address displays in the IP Address column in the Request History section.

- To assign this configuration to the device, highlight the device in the Relation List panel and click Disable BOOTP/DHCP. When power is cycled to the device, it uses the configuration you assigned and does not issue a DHCP request.

TIP To enable DHCP for a device that has had DHCP disabled, highlight the device in the Relation List and click Enable DHCP. You must have an entry for the device in the Relation List panel to re-enable DHCP.

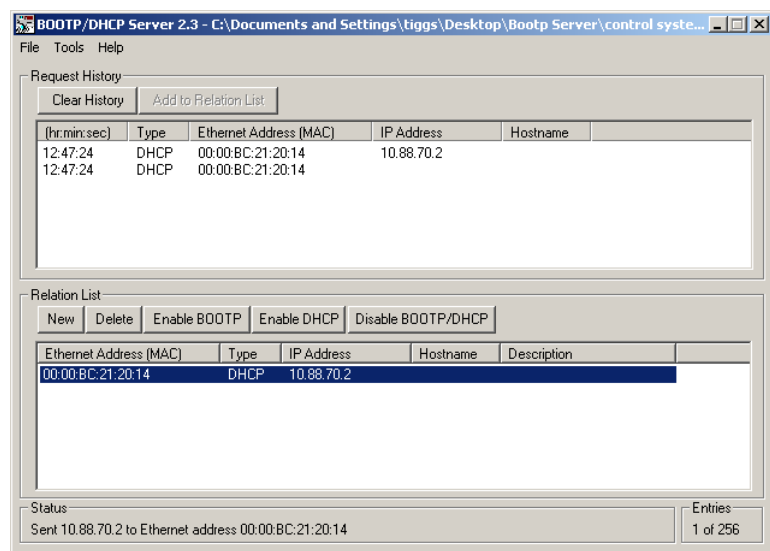

Save the Relation List

You can save the Relation List to use later. To save the Relation List do the following:

1. Select Save As... from the File menu.

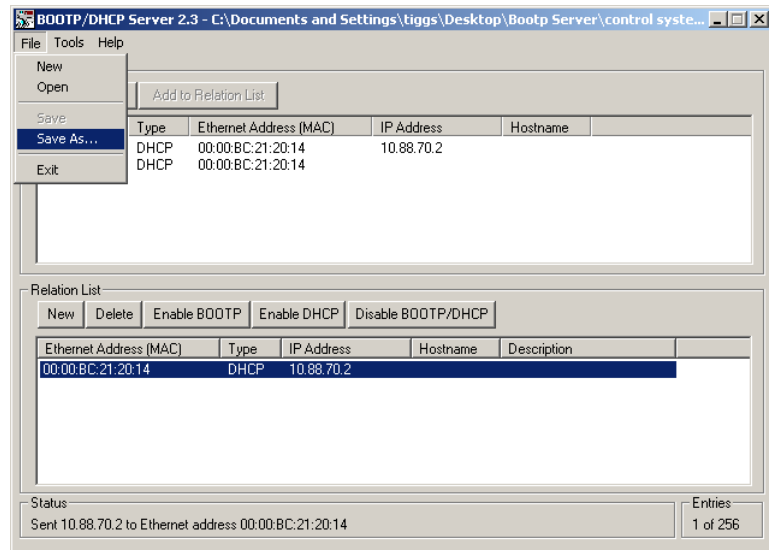

The Save As dialog box appears.

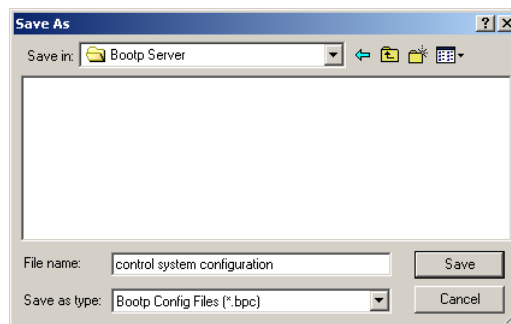

2. Select the folder you want to save the list to.
3. Enter a file name for the Relation List (for example, control system configuration) and click Save.

If you want to see your saved file names in the Open dialog box, save your files using the default file type (*.bpc).

Configure Your Adapter using DHCP Software

DHCP (Dynamic Host Configuration Protocol) software automatically assigns IP addresses to client stations logging onto a TCP/IP network. DHCP is based on BootP and maintains some backward compatibility. The main difference is that BootP was designed for manual configuration, while DHCP allows for

dynamic allocation of network addresses and configurations to newly attached devices.

Be cautious about using DHCP software to configure your adapter. A BootP client, such as the 1794-AENTR or 1794-AENTRXT adapter, can boot from a DHCP server only if the DHCP server is specifically written to also handle BootP queries. This is specific to the DHCP software package you use. Check with your system administrator to see if your DHCP package supports BootP commands and manual IP allocation.



ATTENTION: The 1794-AENTR or 1794-AENTRXT adapter must be assigned a fixed network address. The IP address of this adapter must not be dynamically provided. Failure to observe this precaution may result in unintended machine motion or loss of process control.

Chapter Summary

This chapter described how to configure the module to communicate on your EtherNet/IP network by providing an IP address, gateway address, and Subnet mask. Read the next chapter to learn how to set up your adapter for a rack optimized system.

Rack Optimized Discrete I/O

Overview

In this example a ControlLogix processor communicates with FLEX I/O via the 1794-AENTR adapter using a rack optimized connection. The processor reads data from all digital input modules and sends data to all digital output modules configured in a rack connection simultaneously.

The following table lists where to find specific information within this chapter.

Topic	Page
Set Up the Hardware	23
Create the Example Application	24
Configure the I/O	26
Add the Local EtherNet/IP Bridge to the I/O Configuration	26
Add the FLEX I/O Adapter to the I/O Configuration	27
Add the FLEX I/O Modules to the I/O Configuration	29
Add the Digital Input Module	30
Add the Digital Output Module	31
Edit the Controller Tags	33
Create the Ladder Program	34
Download the Program to the Controller	34
Test the Example Application	35

Set Up the Hardware

In this example, a ControlLogix chassis contains the Logix5572 controller in slot 0 and a 1756-EN2TR bridge module in slot 1. The adapter is mounted on a DIN rail with a 1794-IB16 digital input module and 1794-OB16 digital output module. You also need a power supply (not shown) for the FLEX I/O.

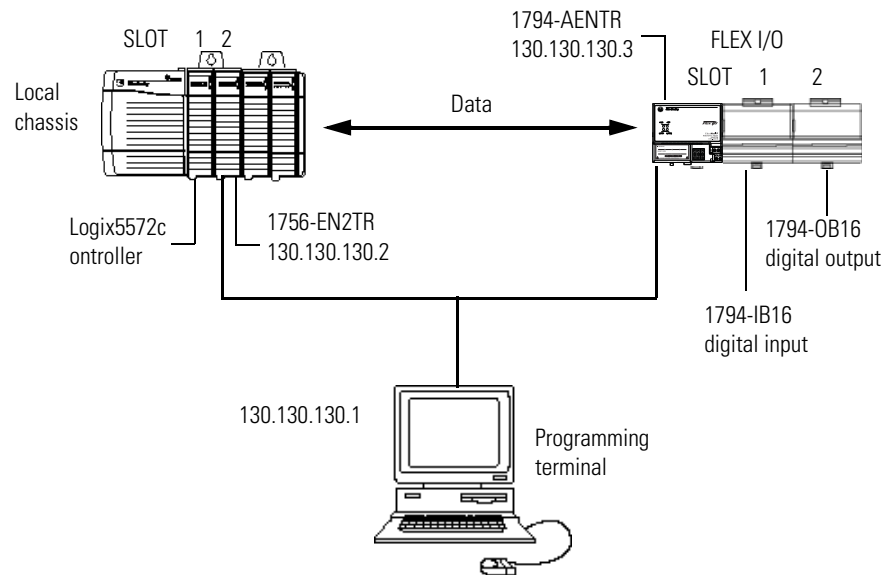

To work along with this example set up your system as shown above.

- Note that in the example application, the Logix5572 controller and 1756-EN2TR module are assumed to be in the slots shown above.
- Verify the IP addresses for your programming terminal, 1756-EN2TR module, and 1794-AENTR adapter.
- Verify the position (slot) of the I/O modules on the DIN rail.
- Verify that all wiring and cabling is properly connected.
- Make sure your communication driver (for example, AB_ETH-1 or AB-ETHIP-1) is configured in RSLinx as described in [Appendix B](#).

Create the Example Application

Perform the following steps to create the example application:

1. Start the RSLogix 5000 Enterprise Series software.
The RSLogix 5000 main dialog opens.

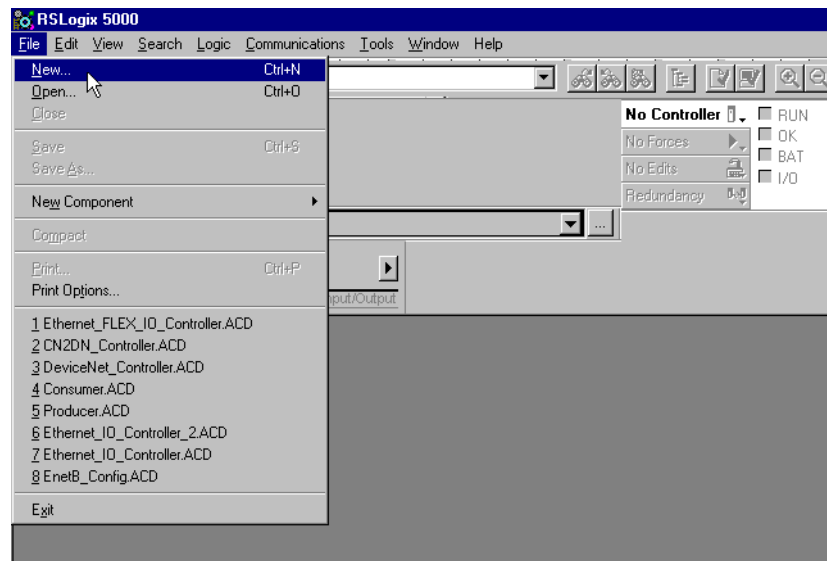

2. From the File menu, select New.
The New Controller dialog opens.

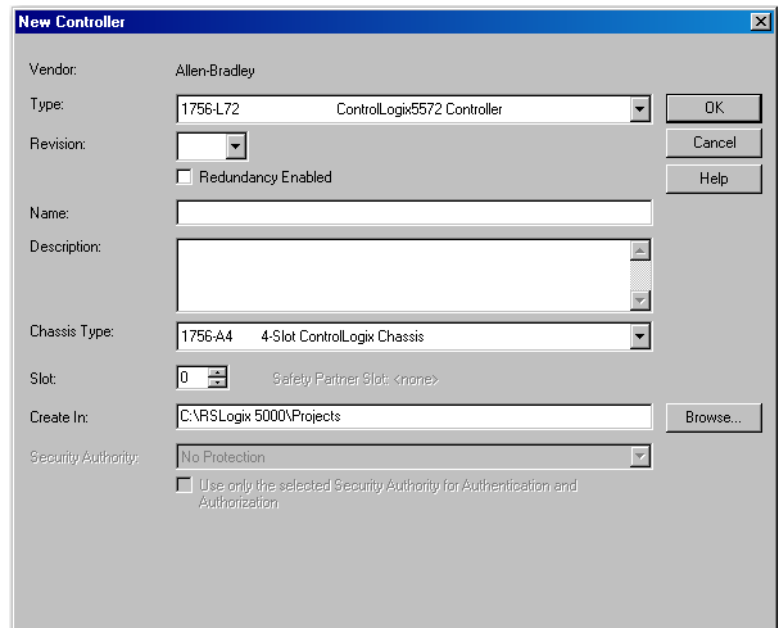

3. Enter an appropriate Name for the Controller, for example:
FLEX_IO_Controller.
4. Select the correct Chassis Type and Slot number of the Logix5572 controller, and the folder where you want to save the RSLogix 5000 file (Create In). The Description is optional.
5. Click OK.

Configure the I/O

Setting up a sample I/O Configuration project involves the following:

- Adding the local 1756-EN2TR module to the I/O configuration.
- Adding the 1794-AENTR adapter as a child of the 1756-EN2TR module.
- Adding the I/O modules as children of the adapter.

IMPORTANT

Click the Help button on the configuration dialogs shown in this section if you need assistance in selecting and setting the parameters.

Add the Local EtherNet/IP Bridge to the I/O Configuration

1. Right-click the I/O Configuration folder in the project window, and then select New Module.

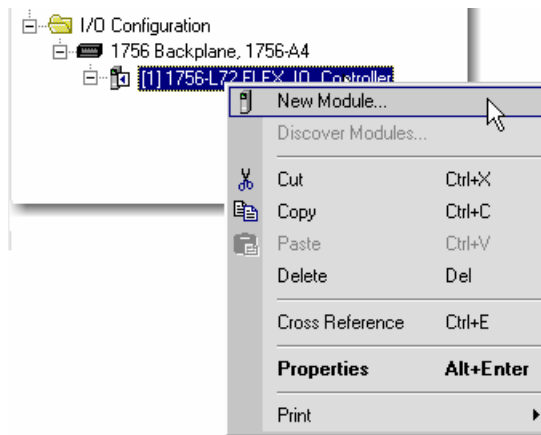

2. The Select Module Type window opens.

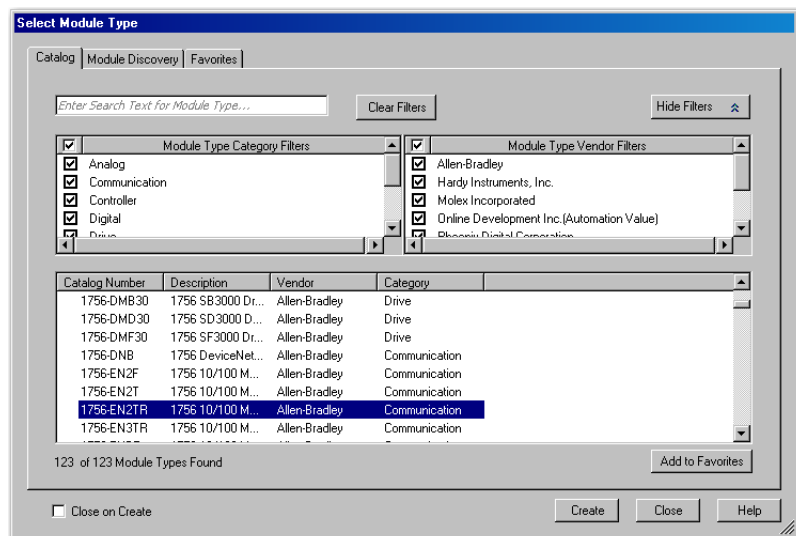

3. Select the 1756-EN2TR EtherNet/IP Bridge, and then click Create. The New Module dialog opens.

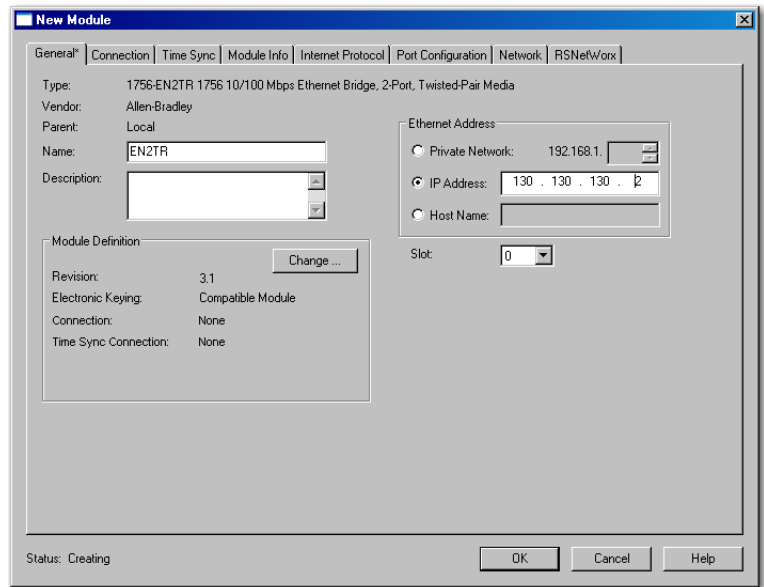

4. Configure your 1756-EN2TR EtherNet/IP Bridge module through the different tabs available. Enter values for Name, IP Address, Slot, Electronic Keying, and Revision, as follows:

Name	EN2TR
IP Address	130.130.130.2
Slot	0
Electronic Keying	Compatible Module
Revision	3.1

5. Click OK to accept the configuration.

Add the FLEX I/O Adapter to the I/O Configuration

Next, you must add the 1794-AENTR adapter as a child of the local 1756-EN2TR module.

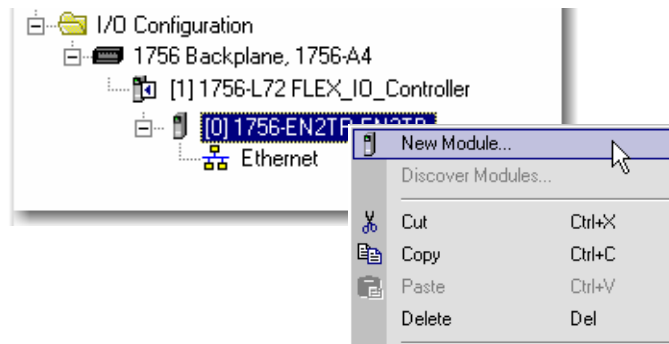

1. In the Project dialog, right-click the local 1756-EN2TR module under the I/O Configuration folder, and then select New Module. The Select Module Type dialog opens.

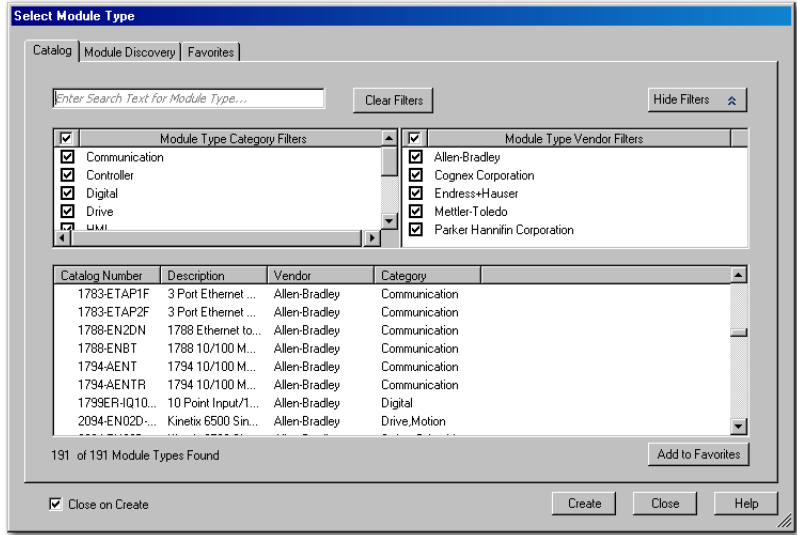

2. Select the 1794-AENTR Ethernet adapter from the list and click Create. The Module Properties dialog opens.

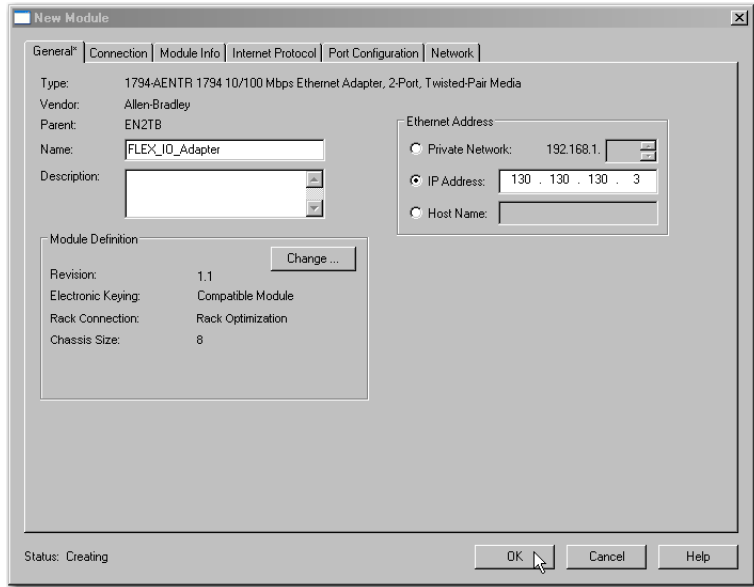

3. Specify the following parameters in the General tab of the New Module dialog:

Name	FLEX_IO_Adapter
IP Address	130.130.130.3

4. Verify that the Module Definition values are as follows:

Comm Format	Rack Optimization
Chassis Size	8 (default)
Electronic Keying	Compatible Module

- If you need to change the values, click Change...
The Module Definition dialog opens.

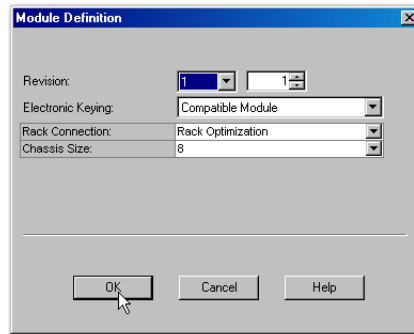

- Click OK to accept the configuration.
The 1794-AENTR adapter appears indented under the local 1794-ENBT in the I/O Configuration folder.

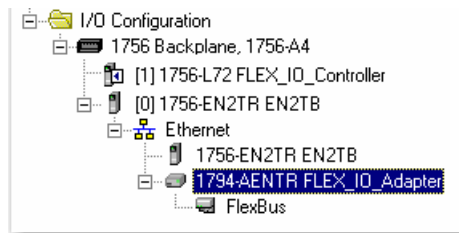

Add the FLEX I/O Modules to the I/O Configuration

You must now add the FLEX I/O modules to the I/O Configuration List under the 1794-AENTR adapter.

In this example, you add a 1794-IB16 digital input module and a 1794-OB16 digital output module with standard configurations. Use these steps as a guide when you are configuring different I/O modules for your system.

TIP

This example application uses I/O module default configurations. For more information, refer to the I/O module publications [1794-IN093](#) and [1794-IN094](#).

Add the Digital Input Module

- Under the I/O Configuration folder, right-click the remote 1794-AENTR adapter, and then select New Module.

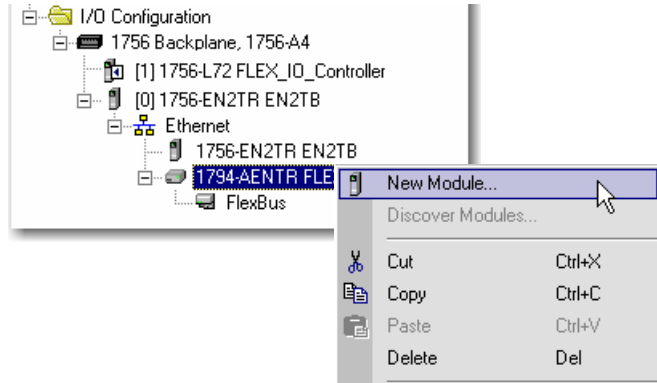

The Select Module Type window opens.

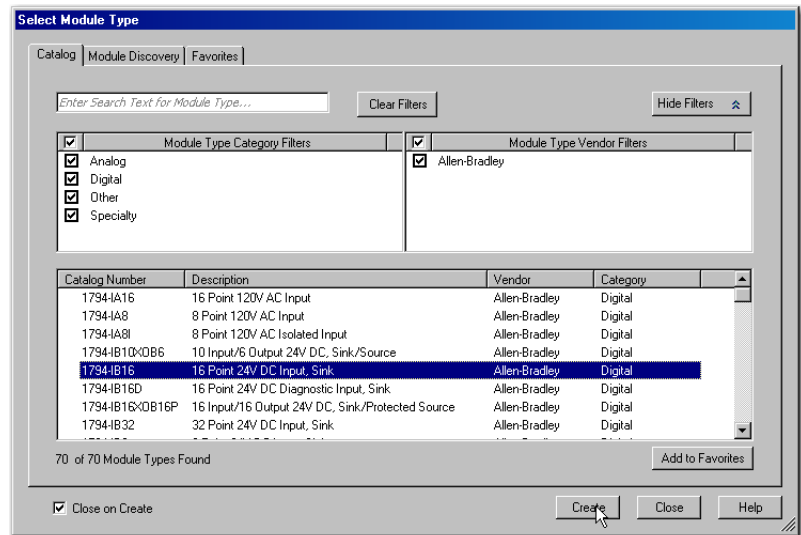

- Select the 1794-IB16 module from the list, and then click Create. The New Module dialog opens.

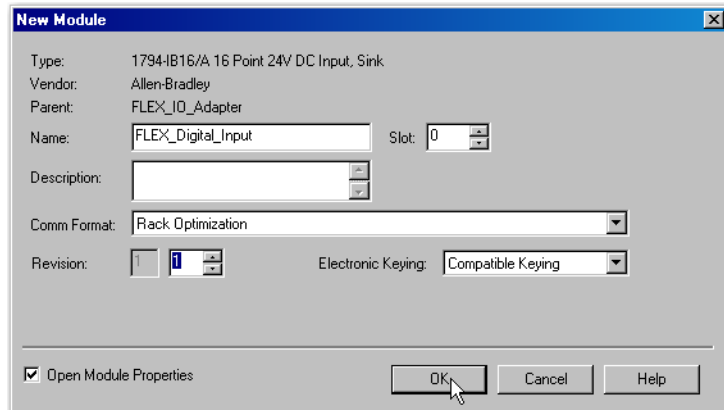

3. Enter the following parameters:

Name	FLEX_Digital_Input
Slot	0
Comm Format	Rack Optimization
Electronic Keying	Compatible Module

4. Click OK to save the configuration.

The digital input module appears in the I/O configuration indented under the 1794-AENTR adapter.

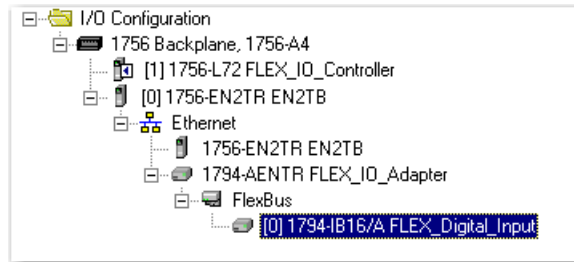

Add the Digital Output Module

1. Under the I/O Configuration folder, right-click the remote 1794-AENTR adapter, and then select New Module.

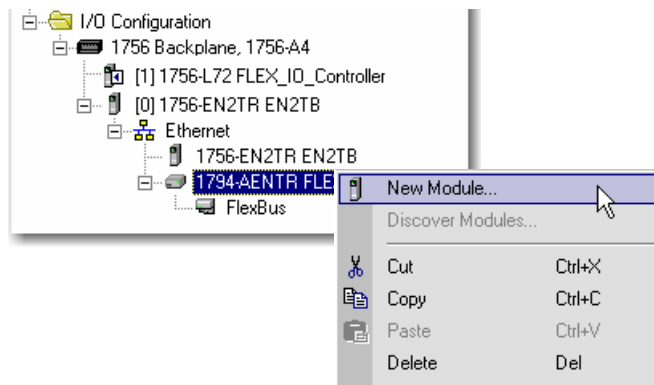

The Select Module Type window opens.

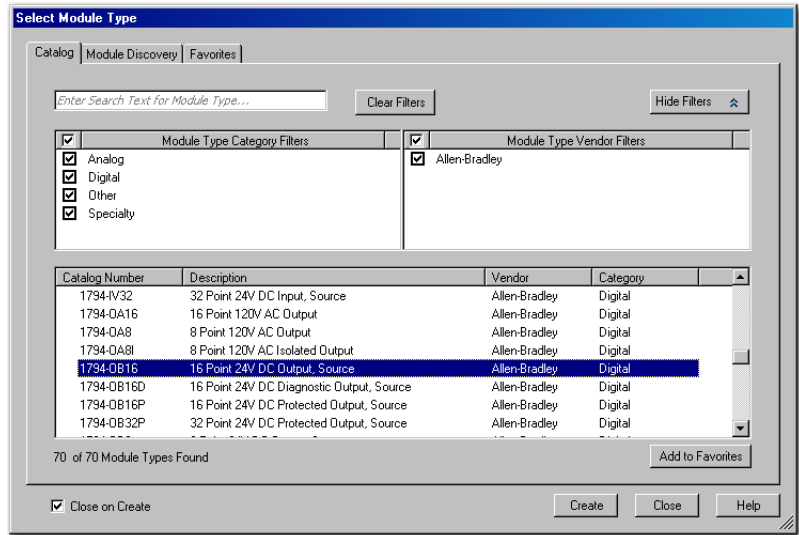

2. Select the 1794-OB16 module from the list, and then click Create. The New Module dialog opens.

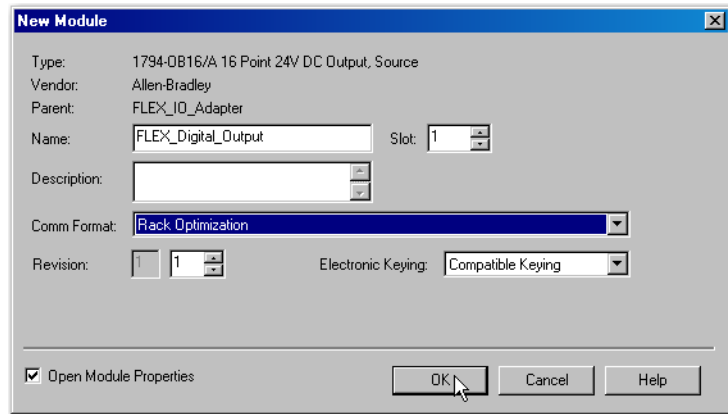

3. Enter the following parameters:

Name	FLEX_Digital_Output
Slot	1
Comm Format	Rack Optimization
Electronic Keying	Compatible Module

- Click OK to save the configuration.
The digital input module appears in the I/O configuration indented under the 1794-AENTR adapter.

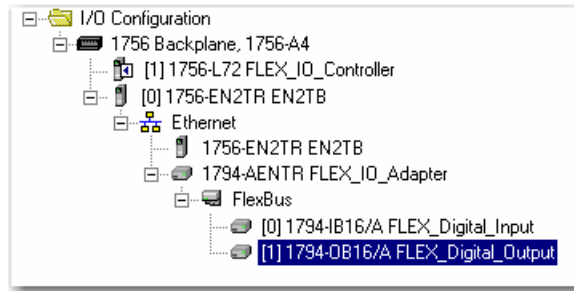

Edit the Controller Tags

When you add modules to the I/O configuration the system creates tags for those modules to use in the application program. For the example application you need to add one more Controller Tag.

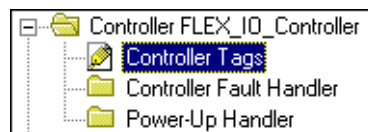

- Double-click the Controller Tags folder in the project window.
The Controller Tags window opens. You see the tags created for the 1794-AENTR and digital I/O modules.

Name	Data Type	Description	Style
FLEX_IO_Ada...	AB:1794_IB16:C:0		
FLEX_IO_Ada...	INT		Binary
FLEX_IO_Ada...	AB:1794_DO16:C:0		
FLEX_IO_Ada...	INT		Binary
FLEX_IO_Ada...	AB:1794_AEN_8...		
FLEX_IO_Ada...	AB:1794_AEN_8...		
Parts_Count	COUNTER		

Tags created by the system

Enter the new tag here

- Make sure you select the Edit Tags tab at the bottom of the Controller Tags window, and then create the following tag:

Tag	Type
Parts_Count	Counter

- Close the Controller Tags window.

Create the Ladder Program

Next, create the example ladder program to test the I/O.

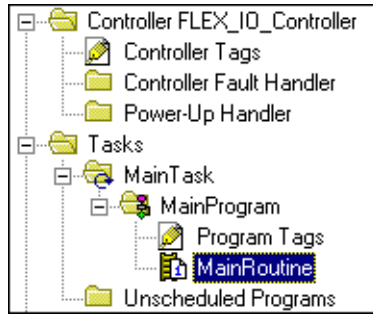

1. Double-click Main Routine under the Main Program folder, and then enter the following ladder program, using the tag previously created.

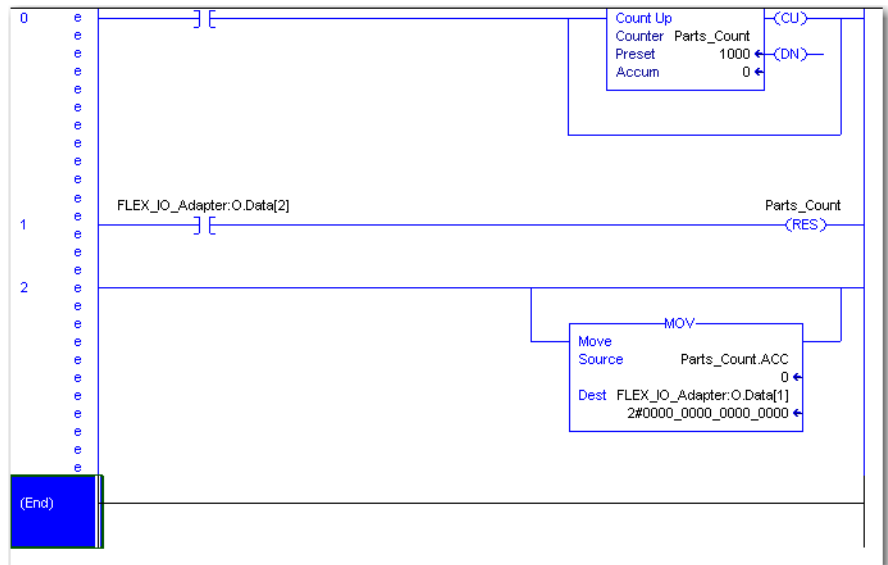

2. Save the program.

Download the Program to the Controller

To download the program to the controller do the following:

1. Click on the Communications menu and select Who Active. The Who Active window opens.

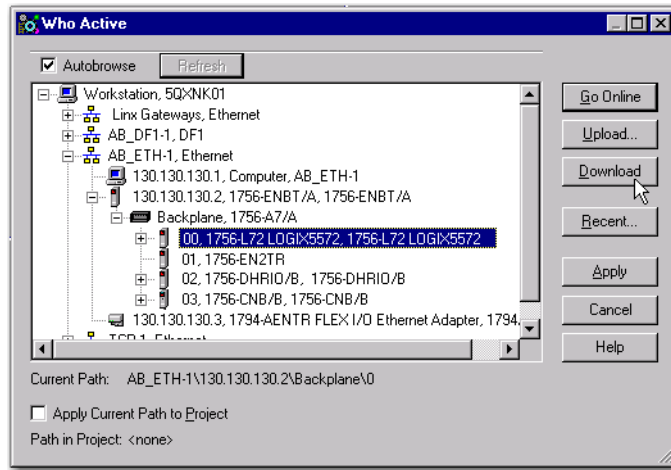

2. Select your Ethernet driver (for example, AB_ETH-1) and expand the tree through the backplane of the local ControlLogix chassis.
3. Highlight the Logix5572 controller and click Download. A Download dialog appears:

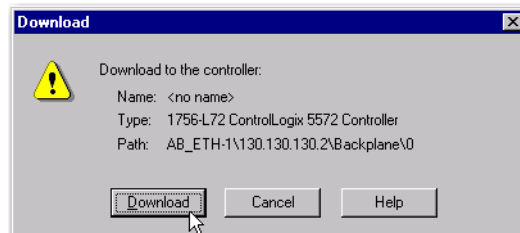

4. Click Download. The program downloads to the controller.
5. Minimize the RSLogix 5000 software.

Test the Example Application

Test the example application by using a momentary switch to simulate a parts sensor.

1. Remove power from the FLEX I/O and wire inputs 0 and 2 of the 1794-IB16 FLEX I/O input module as shown in the following figure:

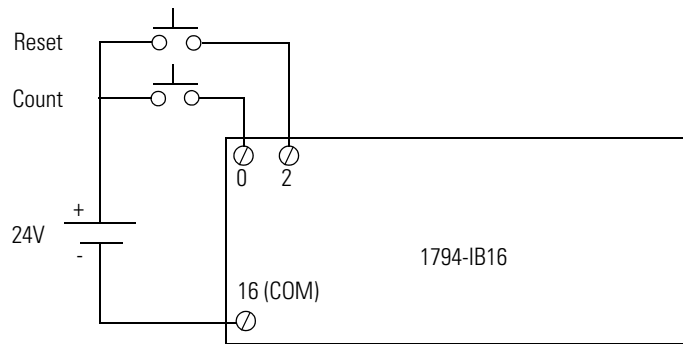

2. Restore power to the FLEX I/O.
3. Restore the RSLogix 5000 software window and place the controller in Run mode.
4. Repeatedly press and release the momentary switch at Input 0 (Count) on the 1794-IB16 input module.
Each time you press the switch the Parts_Count accumulated value increments on the screen and the LEDs of the 1794-OB16 output module increment in binary.

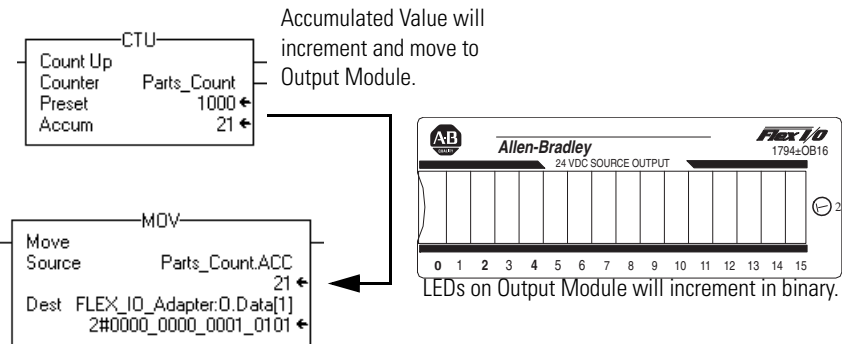

5. Press and release the momentary switch at Input 2 (Reset) on the 1794-IB16 input module.
The accumulated value of the Parts_Count reset to zero and all of the LEDs on the 1794-OB16 output module turn off.

TIP For more information on wiring and interpreting status LED indicators on the I/O modules, refer to the I/O module publications [1794-IN093](#) and [1794-IN094](#).

This completes the Rack Optimized Discrete I/O example.

Chapter Summary

This chapter described how to set up and use rack optimized discrete I/O. The next chapter describes how to add analog I/O modules to a configuration using direct connection.

Analog I/O with Direct Connection

Overview

In this example you add analog input and output modules to the FLEX I/O configured with two digital I/O modules in the previous chapter. Analog modules default to direct connection, so you will open a direct connection to each analog module while still using a single rack optimized connection for the two digital I/O modules.

To test the system, the example of the previous chapter is modified to send a signal to one of the analog output channels and read the signal back in through one of the analog input channels.

Topic	Page
Set Up the Hardware	37
Create the Example Application	38
Add the Analog Modules to the I/O Configuration	39
Add the Analog Input Module to the I/O Configuration	39
Add the Analog Output Module to the I/O Configuration	42
Edit the Controller Tags	45
Modify the Ladder Program	47
Download the Program	47
Test the Example Application	48

Set Up the Hardware

Change the system hardware setup of the previous chapter to that shown below, adding the FLEX analog input and output modules to the DIN rail with the 1794-AENTR adapter and digital I/O modules.

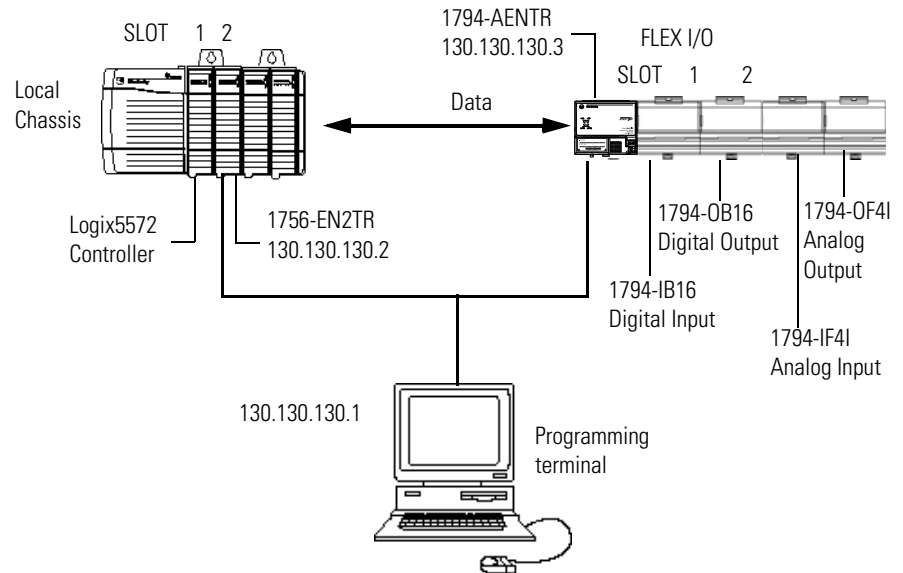

- Note that in the example application, the Logix5572 controller and 1756-EN2TR module are in the slots shown above in the ControlLogix chassis.
- Verify that the IP addresses for the 1756-EN2TR module, 1794-AENTR adapter, and programming terminal are correct.
- Verify the position (slot) of the I/O modules on the DIN rail.
- Verify that all wiring and cabling is properly connected.
- Make sure you have your communication driver (for example, AB_ETH-1 or AB_ETHIP-1) configured in RSLinx as described in [Appendix B](#).

Create the Example Application

Perform the following steps to create the example application:

1. Start the RSLogix 5000 Enterprise Series software.
The RSLogix 5000 main dialog opens.

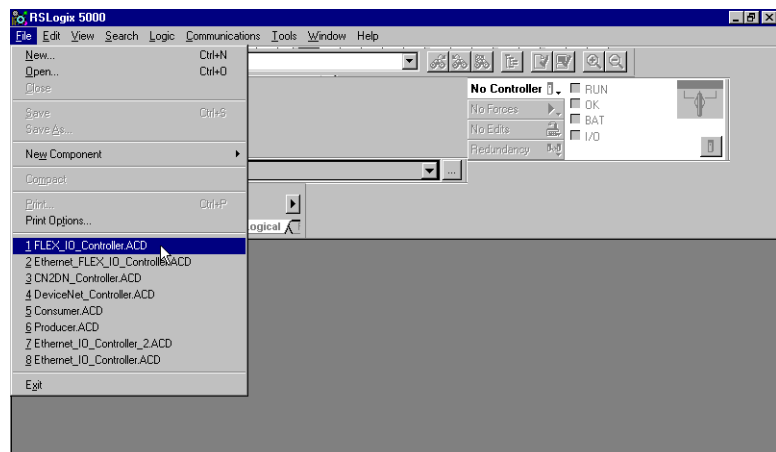

- Open the project file from the previous chapter (for example, FLEX_IO_Controller).

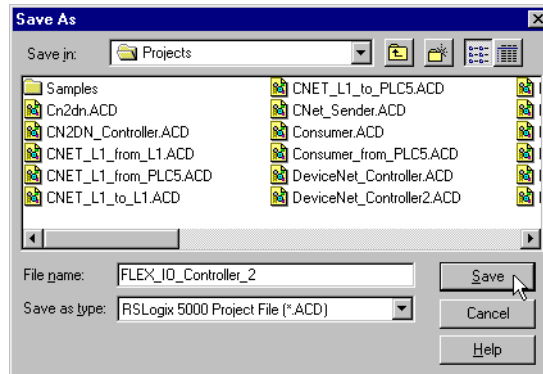

- Save the file using a different name (for example, FLEX_IO_Controller_2).

Add the Analog Modules to the I/O Configuration

You must now add the analog I/O modules to the I/O Configuration. In this example, you add a 1794-IF4I analog input module and a 1794-OF4I analog output module. Use these steps as a guide when you are configuring different I/O modules for your system.

IMPORTANT Click Help on the configuration screens shown in this section if you need assistance in selecting and setting the parameters.

Add the Analog Input Module to the I/O Configuration

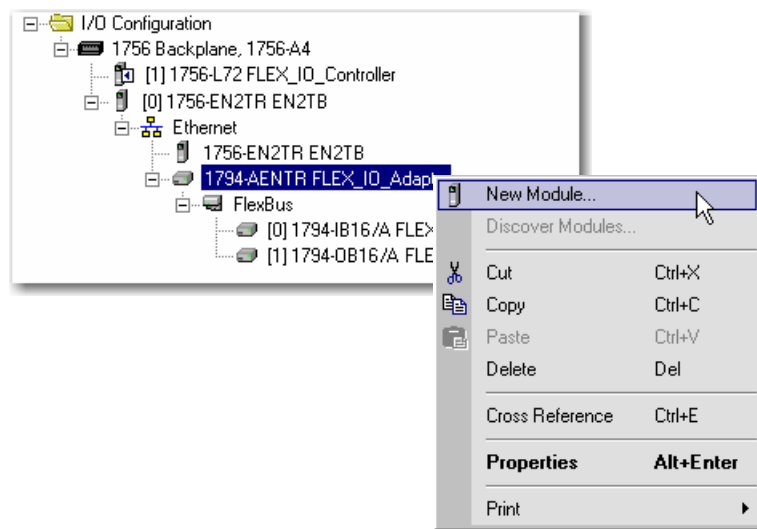

1. Right click the 1794-AENTR adapter under the I/O Configuration folder, and then select New Module.

The Select Module Type window opens.

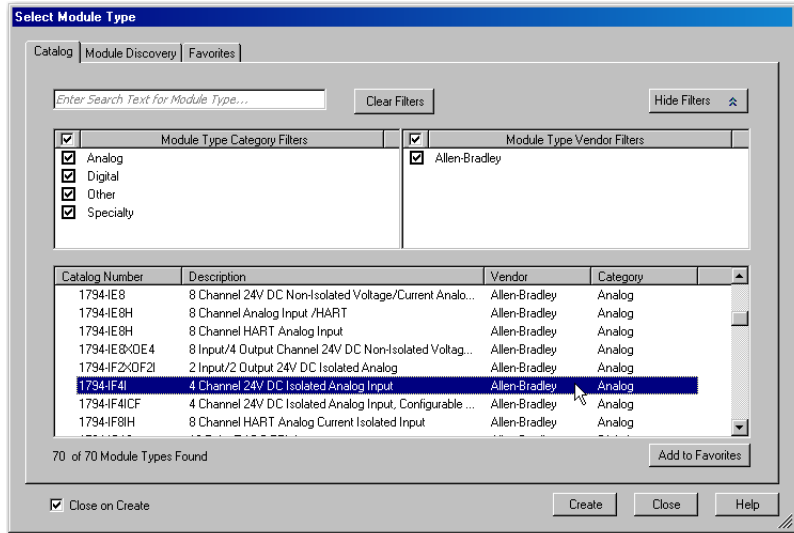

2. Select the 1794-IF4I/A analog input module from the list, and then click Create.

The New Module dialog opens.

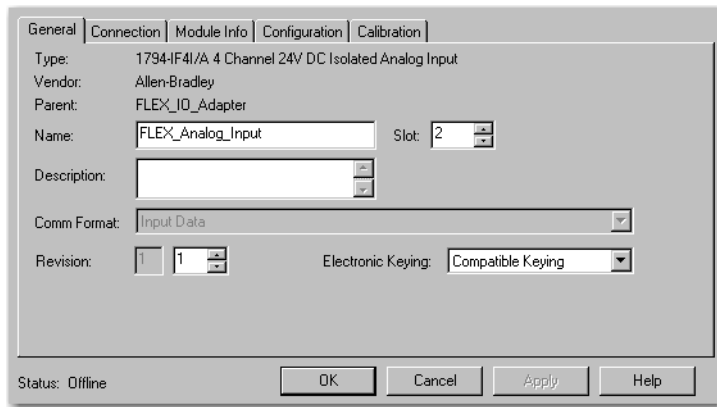

3. Enter the following parameters:

Name	FLEX_Analog_Input
Slot	3
Comm Format	Input Data ⁽¹⁾
Electronic Keying	Compatible Module

⁽¹⁾ All analog Comm Formats use direct connection. The default here is Input Data.

4. Click OK to save the configuration.
The Module Properties Report dialog opens.

- On the Connection tab, adjust the Requested Packet Interval (RPI) to meet your system requirements.

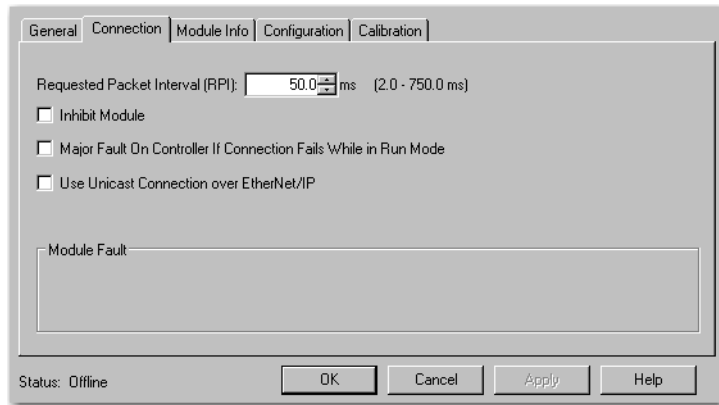

For this example you can leave it at the default 50 ms rate.

This RPI is used for the direct connection to this analog module.

The two rack connected digital I/O modules continue to communicate at the RPI of the rack connection.

- Click Apply to save the configuration.
- On the Configuration tab, use the pull-down list to set the Voltage/Current Range for Channel 0 to 0 to 10V – Binary.

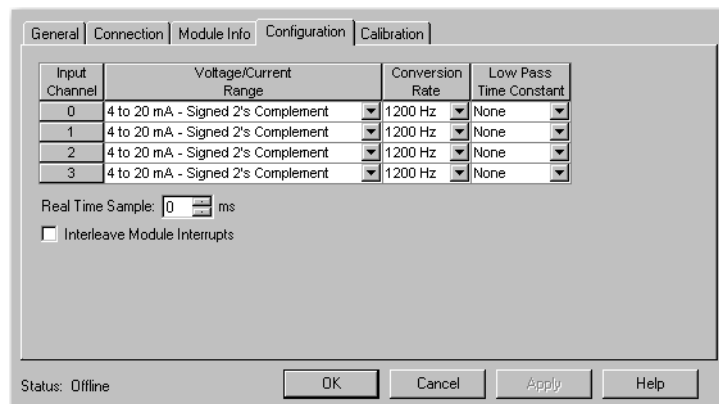

This range allows you to easily monitor the output with a voltmeter when you test the application.

Leave the other channels at their default values.

- Click Apply to save the configuration, and then OK to close the dialog. The analog input module appears in the I/O configuration indented under the 1794-AENTR adapter.

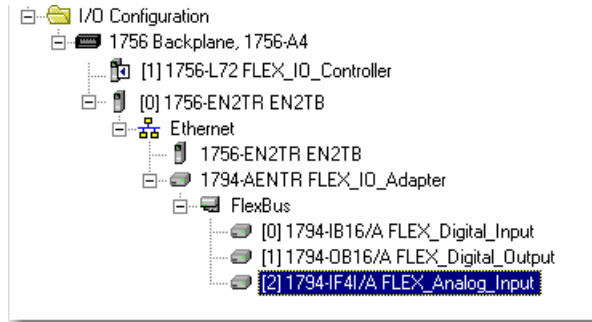

Add the Analog Output Module to the I/O Configuration

- Under the I/O Configuration folder, right-click the remote 1794-AENTR adapter, and then select New Module.

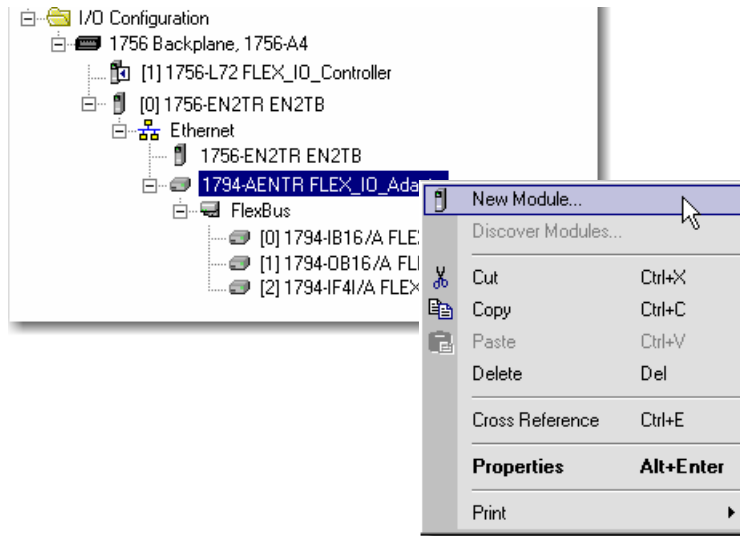

The Select Module Type window opens.

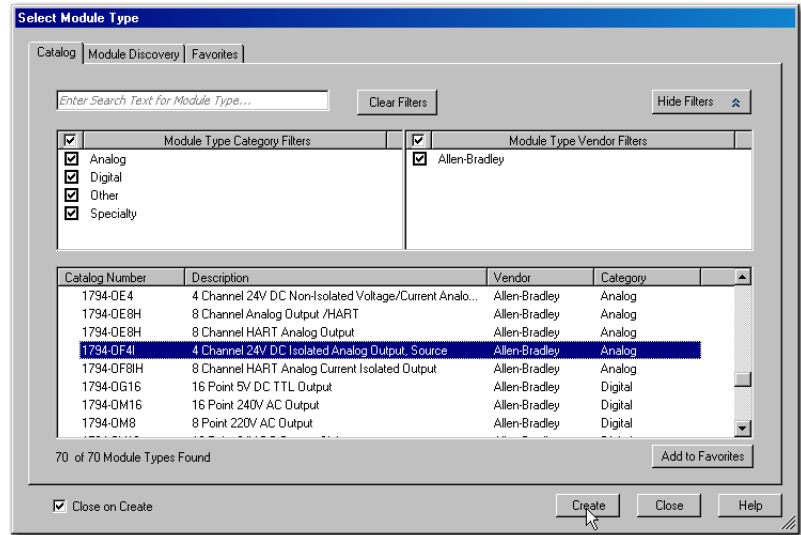

2. Select the 1794-OF4I module from the list, and then click Create. The New Module dialog opens.

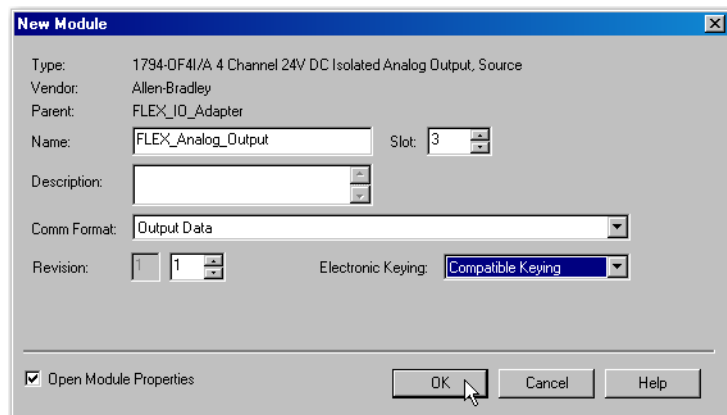

3. Enter the following parameters:

Name	FLEX_Analog_Output
Slot	3
Comm Format	Output Data ⁽¹⁾
Electronic Keying	Compatible Module

⁽¹⁾ All analog Comm Formats use direct connection. The default here is Output Data.

4. Click OK to save the configuration. The Module Properties Report dialog opens.

- On the Connection tab, adjust the Requested Packet Interval (RPI) to meet your system requirements.

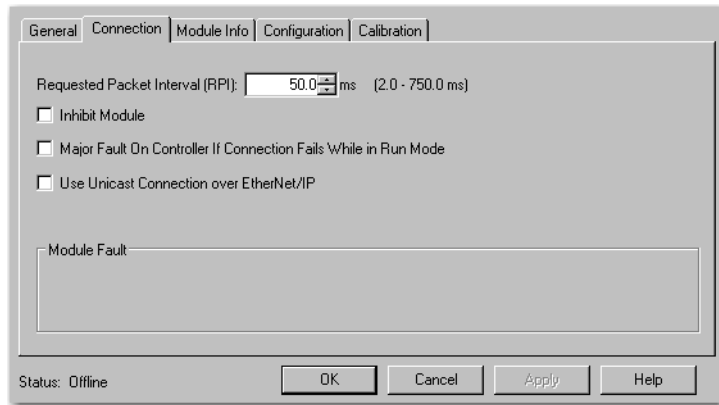

For this example change the RPI to 50 ms rate.

This RPI is used for the direct connection to this analog module.

The two rack connected digital I/O modules continue to communicate at the RPI of the rack connection.

- Click Apply to save the configuration.
- Click the Fault/Idle Action tab.

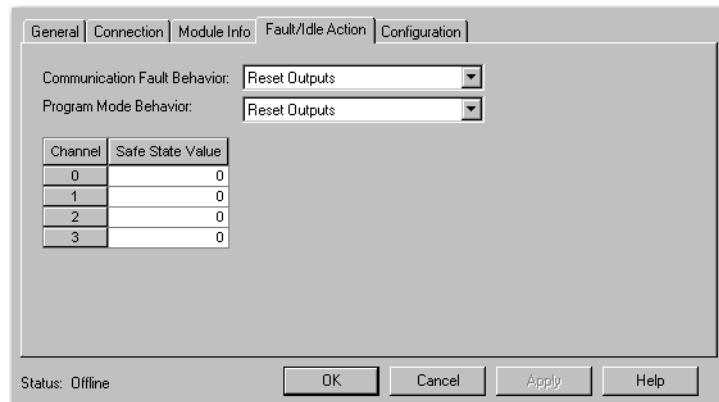

For this example, leave these parameters at the default setting.

For an explanation of these parameters click Help.

- On the Configuration tab, use the pull-down list to set the Voltage/Current Range for Channel 0 to 0 to 10V – Binary to match the input configuration of the 1794-IF4I module.

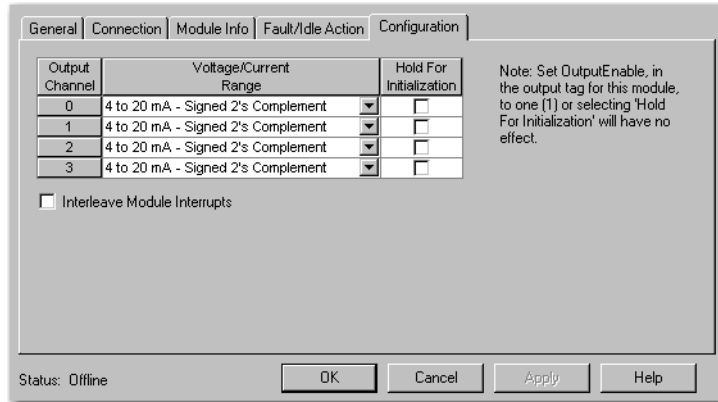

Leave the other channels at their default values.

- Click Apply to save the configuration, and then OK to close the dialog. The analog input module appears in the I/O configuration indented under the 1794-AENTR adapter.

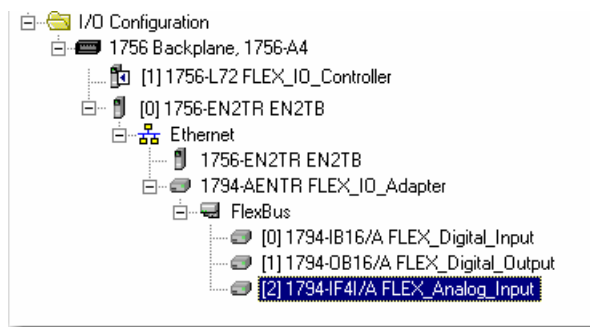

Edit the Controller Tags

When you add modules to the I/O configuration the system creates Controller Tags for those modules. For the example program you need to add one more Controller Tag.



1. Double-click the Controller Tags folder in the project window. Note that new tags have been added for the analog I/O modules.

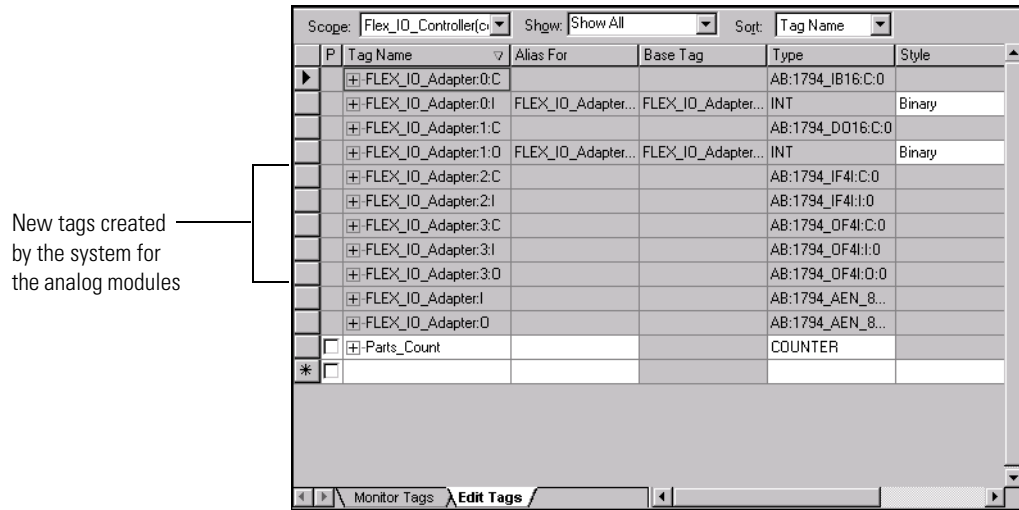

Make sure you select the Edit Tags tab at the bottom of the Controller Tags window, and then create the following tag:

Tag	Type
Analog_Test_Signal	Timer



Modify the Ladder Program

Make the following change to the ladder program to test the new configuration.

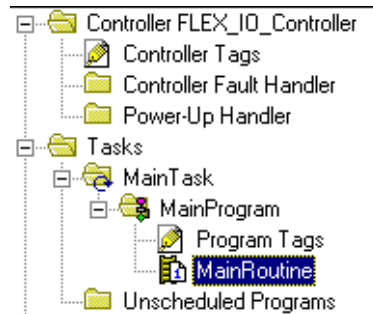

2. Double-click Main Routine under the Main Program folder, and then add rungs 3 and 4 to the ladder program.

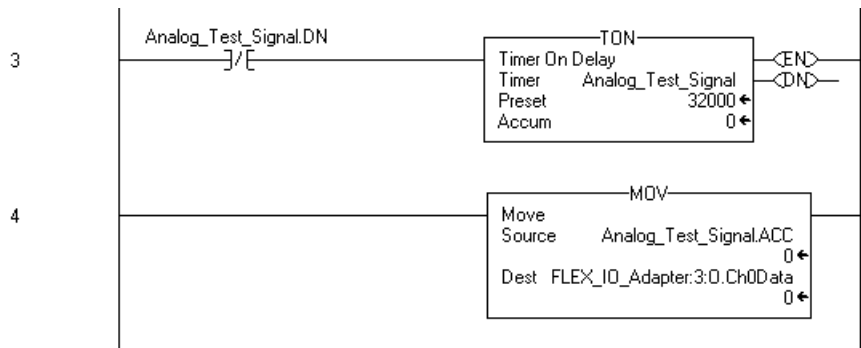

3. Save the program.

Download the Program

To download the program to the controller do the following:

1. Click the Communications menu, and then select Who Active. The Who Active window opens.

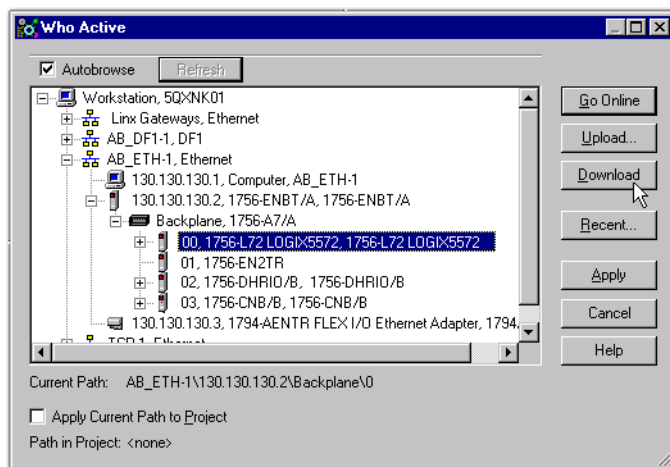

2. Select your Ethernet driver (for example, AB_ETH-1) and expand the tree through the backplane of the local ControlLogix chassis.
3. Highlight the controller, and then click Download to download the program to the Logix5572 controller.
A Download dialog appears:

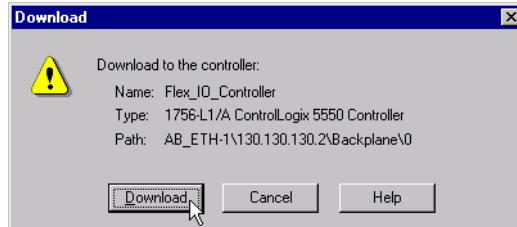

4. Click Download.
The program downloads to the controller.
5. Minimize the RSLogix 5000 software window.

Test the Example Application

Use the following procedure to test the operation of the FLEX analog input and output modules:

1. Connect analog output channel 0 on the 1794-OF4I/A module to analog input channel 0 on the 1794-IF4I/A input module.

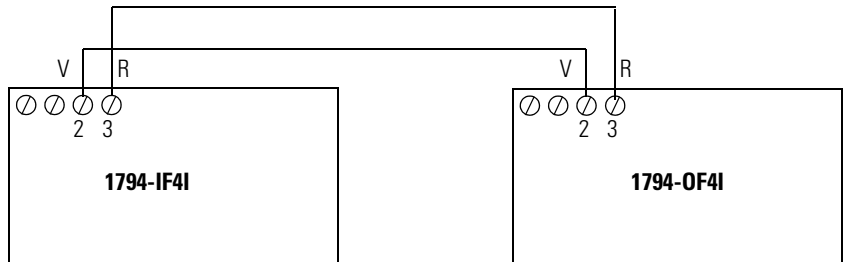

2. Restore the RSLogix 5000 software window and place the controller in Run mode.
3. Double-click the Controller Tags folder, and then select the Monitor tab.

Tag Name	Value	Force Mask	Style	Type
+	{...}	{...}		AB:17
+	2#0000_000...		Binary	INT
+	{...}	{...}		AB:17
+	2#0000_000...		Binary	INT
+	{...}	{...}		AB:17
-	{...}	{...}		AB:17
+	2#0000_000...		Binary	DINT
+	25461		Decimal	INT
+	0		Decimal	INT
+	0		Decimal	INT
+	0		Decimal	INT

4. Monitor channel 0 of the 1794-IF4I input module (FLEX_IO_Adapter:2.I.Ch0Data above).

The value slowly rises to approximately 32000, resets to zero, starts rising again, and so on, as the output of the timer is received from the 1794-OF4I output module.

TIP For information on wiring and troubleshooting the I/O modules, refer to the FLEX I/O Analog I/O Module Installation Instructions, publications [1794-IN037](#) and [1794-IN038](#).

This completes the Direct Connect Analog I/O example.

Chapter Summary

This chapter described how to set up and use analog I/O modules with direct connection.

Notes:

Interpret Status Indicators

Overview

The faceplates of the 1794-AENT and 1794-AENTRXT adapters are provided with status indicators that display the Module Status, Network Status, and Link Status for both links.

Status Indicators

1794-AENTR, 1794-AENTRXT Module

1794-AENTR shown

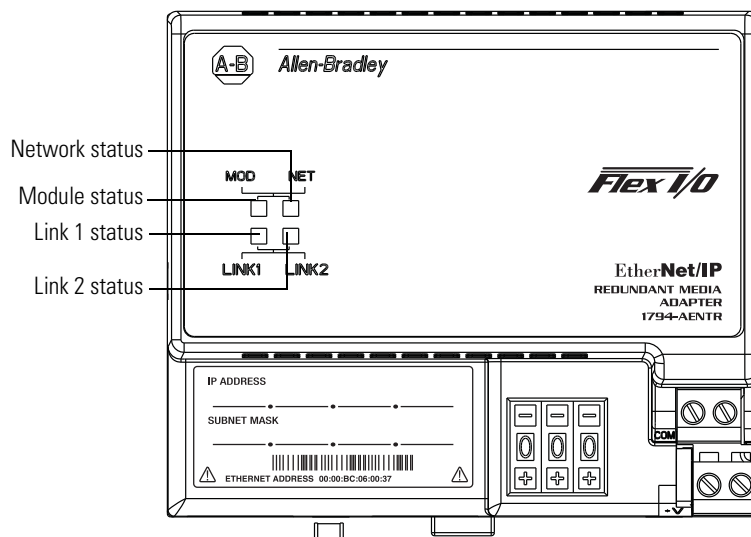

44560

Use the following table to determine the indicator conditions and status.

Status Indicator Identification

Indicator	State	Status
Link 1 or Link 2 (individually)	Off	No link exists. Verify network cabling. Correct as necessary.
	Solid green	Link exists at 100 Mbps.
	Flashing green	I/O is being transmitted or received at 100 Mbps.
	Flashing yellow	I/O is being transmitted or received at 10 Mbps.
	Solid yellow	Link exists at 10 Mbps.

Status Indicator Identification

Indicator	State	Status
Module Status Indicator	Off	No power. Adapter does not have 24V DC power. Make sure power is being supplied to the adapter.
	Flashing green	Standby. Adapter not configured. Configure adapter.
	Green	Operational. Adapter operating correctly. No action required.
	Flashing red	Minor fault. A recoverable fault has been detected. This could be caused by an incorrect or inconsistent configuration. Check configuration and reconfigure as needed.
	Solid red	Major fault. An unrecoverable fault has been detected. Recycle power to the adapter. If this does not clear the fault, replace the adapter.
	Flashing red/green	Self test. Adapter performing power-up self test. Wait until completed.
Network Status Indicator	Off	Not powered. No IP address. Adapter is not powered or does not have an IP address. Verify there is power and the adapter is correctly wired to the power supply. Make sure the adapter is configured.
	Flashing green	No connection. Adapter has obtained an IP address, but has no established connections.
	Green	CIP connections. Adapter has an IP address and at least one established connection.
	Flashing red	Connection timeout. One or more of the connections in which the adapter is the target has timed out.
	Red	Duplicate IP address. Adapter has detected that its IP address is already in use. Configure the adapter with a unique IP address.
	Flashing red/green	Self-test. Adapter performing power-up self test.

Chapter Summary

This appendix described how to troubleshoot your adapter module by interpreting the status indicators.

Configure the RSLinx Ethernet Communication Driver

Overview

Read this appendix to install, and configure the AB_ETH driver.

For Information On	Page
About the Ethernet Communication Driver	53
Install the RSLinx Software	53
Configure the AB_ETH Driver	53

About the Ethernet Communication Driver

In order to communicate with your 1794-AENTR or 1794-AENTRXT adapters over your network you must configure the RSLinx Ethernet communication driver (AB_ETH). You can configure the AB_ETH driver with the IP addresses of all the Ethernet devices on your system. You will need this driver to download the example application programs in this manual.

Install the RSLinx Software

Use the following procedure to install RSLinx software on your computer.

1. Insert the CD in the CD-ROM drive.
Note: The CD-ROM supports Windows Autorun. Once inserted into the CD-ROM drive, if you have Autorun configured, the installation will automatically start at the first setup screen.

If Autorun is not configured for your CD-ROM drive, go to step 2.

2. From the Start menu, choose Run.
The Run pop-up window appears.
3. Type D:/setup (if it doesn't appear automatically), where D: is your CD-ROM driver letter.
4. Click OK.
The progress bar appears, followed by the welcome screen.

Configure the AB_ETH Driver

To configure the AB_ETH Ethernet communication driver perform the following steps:

1. Start RSLinx.

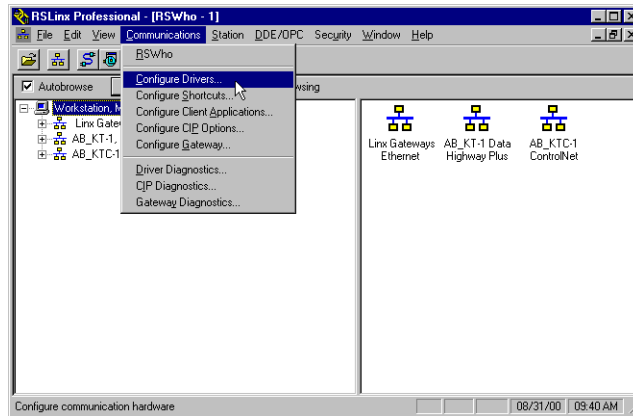

2. From the Communications menu, select Configure Drivers.
3. From the Available Driver Types drop down menu, select Ethernet Devices, and then click Add/New.
The Add New RSLinx Driver dialog box appears.

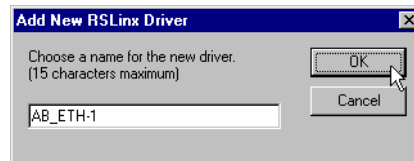

4. Select the default driver name (for example, AB_ETH-1) or type in your own name and click OK.
The Configure driver dialog appear with the Station Mapping tab open.

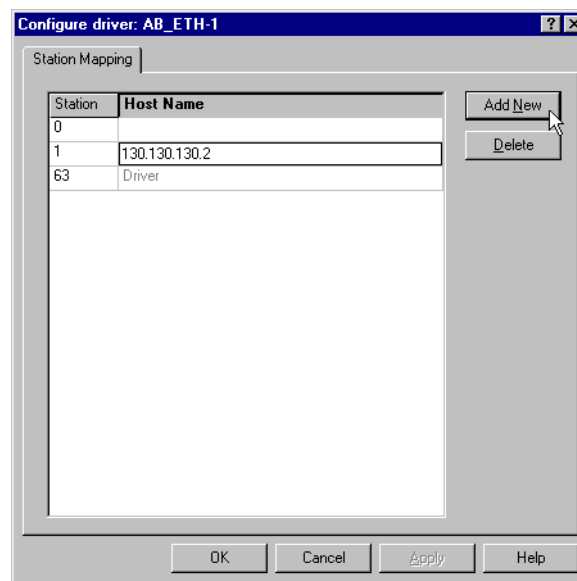

5. Click Add New and enter the IP address or Host Name of your Ethernet device (for example, 130.130.130.2, "Pump1").
6. Repeat step 5 for each additional Ethernet device you need to access.

- When you are done entering the IP addresses, click Apply and then click OK to close the Configure driver window.

The new driver appears in the list of configured drivers. Your list displays the drivers you have configured on your workstation.

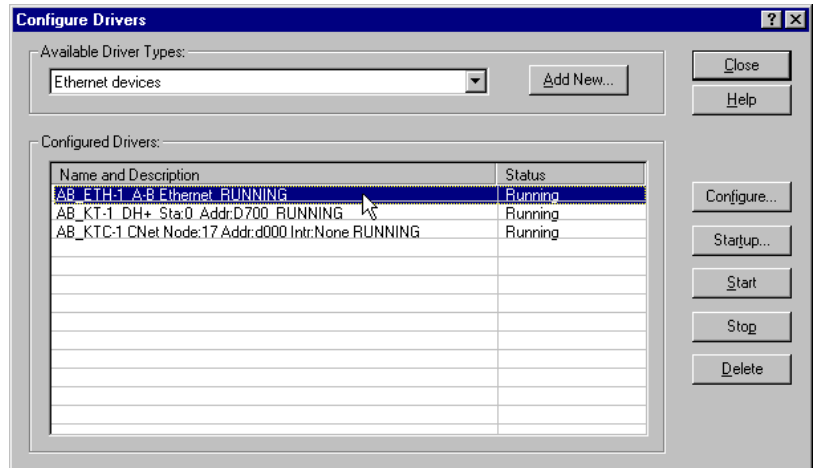

- Close RSLinx.

Notes:

Adapter Web Dialogs

Overview

The Web server dialog of the FLEX I/O adapter offers extensive internal and network diagnostics. To view the Web dialogs, enter the IP address of the FLEX I/O adapters into your browser.

Topic	Page
Work with the Home Page	57
Work with the Diagnostics Pages	59
Use the Diagnostic Overview Page	60
Use the Network Configuration Page	66
Use the Ethernet Statistics Page	62
Use the I/O Connections Page	63
Work with the Configuration Pages	64
Use the Device Identity Page	65
Use the Network Configuration Page	66
Use the Device Services Page	68

Work with the Home Page

Use the adapter diagnostics home page to access other adapter diagnostics web pages and see the following information.

- ModuleName
- Module Description
- Module Location
- IP Address
- Ethernet Address (MAC)
- DHCP Enabled
- Status
- Serial Number
- Product Revision
- Firmware Version Date

To display and work with the adapter diagnostics home page, follow these procedures.

IMPORTANT Make sure that your PC Internet LAN setting and your TCP/IP settings are configured to access the subnet on which your adapter communicates.

1. From your web browser, enter the adapter IP address to see the Home page.

Enter the adapter IP address to see the home page.

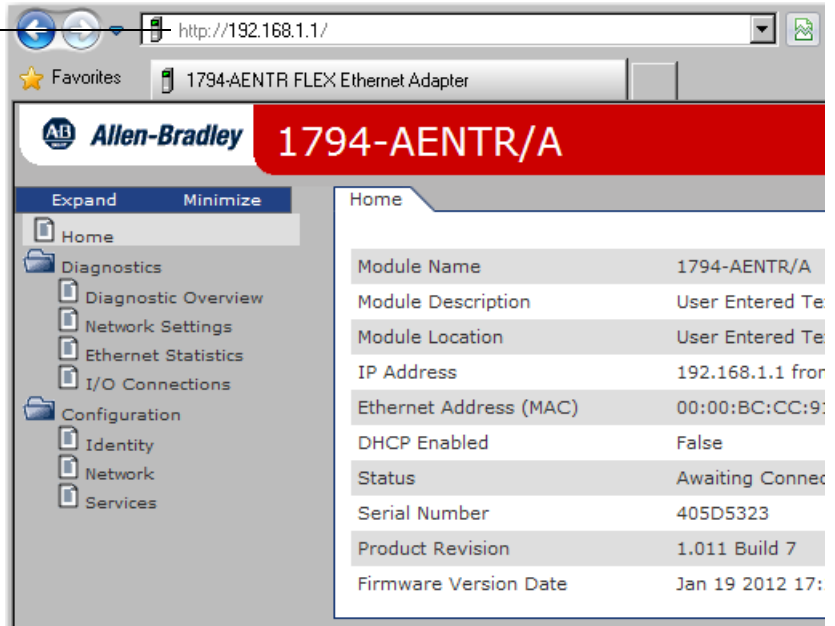

2. From the Home page, click Expand to show options, or minimize to see Diagnostics and Configuration.

Click Expand to show options.

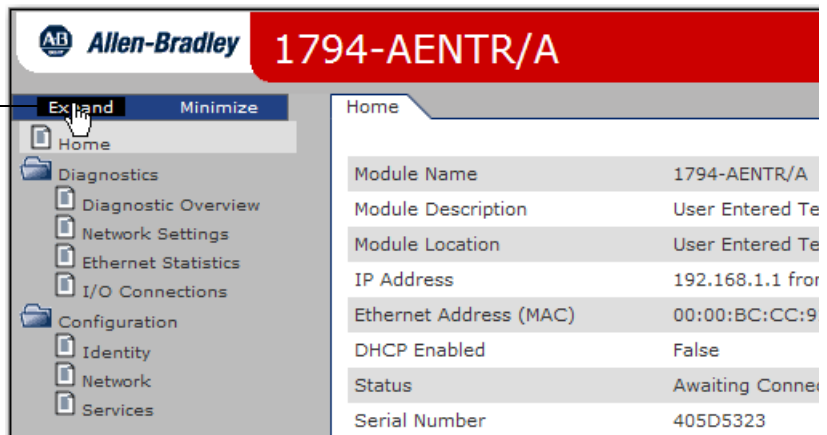

3. From the Home page, complete one of these, as desired.
 - Click one of the following to access www.ab.com.
 - Allen-Bradley logo at the top of the page
 - AB.com link under Resources on the right hand side of the page
 - Click Rockwell Automation at the top right to go to www.rockwellautomation.com.
 - Click the following to see additional diagnostics web pages.
 - Diagnostics – Diagnostic overview, Network Settings, Ethernet Statistics, I/O Connections
 - Configuration – Identity, Network, Services

Work with the Diagnostics Pages

To work with the Diagnostics options, follow these procedures.

- From the Home page, click Diagnostics or Expand to see the following diagnostics options from the panel at the left.
 - Diagnostic Overview
 - Network Settings
 - Ethernet Statistics
 - I/O Connections
- In the Refresh Rate field, you can type a refresh rate, noting that the default rate is 15 seconds.
- From the panel at the left or tabs at the top of the page, click one of the diagnostics options to see the corresponding page.

Click tabs to see the corresponding page.

Click Diagnostics options to see corresponding pages

Type a refresh rate.

Download EDS files for your adapter

Allen-Bradley 1794-AENTR/A

Expand Minimize

Home

Diagnostics

Diagnostic Overview

Network Settings

Ethernet Statistics

I/O Connections

Configuration

Diagnostic Overview Network Settings Ethernet Statistics I/O Connections

Refresh Rate [sec] 15

Ring Status		Module Setting
Network Topology	Linear	Switches
Network Status	Normal	
Ring Supervisor	00:00:00:00:00:00 0.0.0.0	

System Resource Utilization	
CPU Utilization	23.8% (23.8%[pk])
Module Uptime	01h:23m:22s

CIP Connection Statistics	
Current CIP Msg Connections	0
CIP Msg Connection Limit	32
Max Msg Connections Observed	0
Current CIP I/O Connections	0
CIP I/O Connection Limit	31
Max I/O Connections Observed	0
Conn Opens	0
Open Errors	0
Conn Closes	0
Close Errors	0
Conn Timeouts	0

LED Status :

Module Status ■

Network Status ■

[Get 1794-AENTR EDS Files](#)

Use the Diagnostic Overview Page

To use the Diagnostic Overview page for general diagnostics information, click Diagnostic Overview from the tab at the top of the page or panel on the left.

From the Diagnostic Overview page, you can view the following:

- Ring Status
 - Network Topology
 - Network Status
 - Ring Supervisor
- System Resource Utilitization
 - CPU Utilization
 - Module Uptime
- CIP Connection Statistics
 - Current CIP MSG Connections
 - CIP MSG Connection Limit
 - Max Msg Connections Observed
 - Current CIP I/O Connections
 - CIP I/O Connection Limit
 - Max I/O Connections Observed
 - Conn Opens
 - Open Errors
 - Conn Closes
 - Close Errors
 - Conn Timeout
- Module Settings
 - Switches

Use the Network Settings Page

To use the Network Settings page for network related information, click Network Settings tab at the top of the page or panel on the left.

This opens the Network Settings page.

The screenshot shows the Allen-Bradley 1794-AENTR/A Network Settings page. The page is divided into several sections:

- Navigation Menu (Left):** Includes Home, Diagnostics, Network Settings (selected), Ethernet Statistics, I/O Connections, and Configuration.
- Page Header:** Allen-Bradley logo, model number 1794-AENTR/A, and Rockwell Automation logo.
- Tabbed Interface:** Diagnostic Overview, Network Settings (active), Ethernet Statistics, and I/O Connections.
- Network Interface Section:**

Ethernet Address (MAC)	00:00:BC:CC:91:D7
IP Address	192.168.1.1
Subnet Mask	255.255.255.0
Default Gateway	0.0.0.0
Primary Name Server	0.0.0.0
Secondary Name Server	0.0.0.0
Default Domain Name	
Host Name	
Name Resolution	DNS Disabled
- Ethernet Interface Configuration Section:**

Obtain Network Configuration	Static
------------------------------	--------
- Ethernet Port 1 Section:**

Interface State	Enabled
Link Status	Active
Media Speed	100Mbps
Duplex	Full Duplex
Autonegotiate Status	Media speed and duplex found
- Ethernet Port 2 Section:**

Interface State	Enabled
Link Status	Active
Media Speed	100Mbps
Duplex	Full Duplex
Autonegotiate Status	Media speed and duplex found

Copyright © 2011, Rockwell Automation, Inc. All rights reserved.

From the Network Settings page, you can view the following:

- Network Interface
 - Ethernet Address (MAC)
 - IP Address
 - Subnet Mask
 - Default Gateway
 - Primary Name Server
 - Secondary Name Server
 - Default Domain Name
 - Host Name
 - Name Resolution
- Ethernet Interface Configuration
 - Obtain Network Configuration
- Ethernet Port 1 and 2
 - Interface State
 - Link Status
 - Media Speed
 - Duplex
 - Autonegotiate Status

Use the Ethernet Statistics Page

To use the Ethernet Statistics page for information about the Ethernet link and interface and media counters, click Ethernet Statistics tab at the top of the page or from the panel on the left.

The Ethernet Statistics page opens.

Allen-Bradley 1794-AENTR/A Rockwell Automation

Diagnostic Overview Network Settings **Ethernet Statistics** I/O Connections

Expand Minimize

Home
Diagnostics
Diagnostic Overview
Network Settings
Ethernet Statistics
I/O Connections
Configuration

Refresh Rate [sec] 15

Ethernet Port 1		Media Counters Port 1	
Interface State	Enabled	Alignment Errors	0
Link Status	Active	FCS Errors	0
Media Speed	100Mbps	Single Collisions	0
Duplex	Full Duplex	Multiple Collisions	0
Autonegotiate Status	Media speed and duplex found	SQE Test Errors	0
		Deferred Transmissions	0
		Late Collisions	0
		Excessive Collisions	0
		MAC Transmit Errors	0
		Carrier Sense Errors	0
		Frame Too Long	0
		MAC Receive Errors	0

Ethernet Port 2		Media Counters Port 2	
Interface State	Enabled	Alignment Errors	0
Link Status	Active	FCS Errors	0
Media Speed	100Mbps	Single Collisions	0
Duplex	Full Duplex	Multiple Collisions	0
Autonegotiate Status	Media speed and duplex found	SQE Test Errors	0
		Deferred Transmissions	0
		Late Collisions	0
		Excessive Collisions	0
		MAC Transmit Errors	0
		Carrier Sense Errors	0
		Frame Too Long	0
		MAC Receive Errors	0

Interface Counters	
In Octets	770245
In Ucast Packets	2501
In NUCast Packets	724
In Discards	0
In Errors	0
In Unknown Protos	0
Out Octets	617352
Out Ucast Packets	1637
Out NUCast Packets	103
Out Discards	0
Out Errors	0

From the Ethernet Statistics page, you can view the following:

- Ethernet Port 1 and Port 2
 - Interface State
 - Link Status
 - Media Speed
 - Duplex
 - Autonegotiate Status
- Media Counters Port 1 and Port 2
 - Alignment Errors

- FCS Errors
- Single Collisions
- SQE Test Errors
- Deferred Transmissions
- Late Collisions
- Excessive Collisions
- MAC Transmit Errors
- Carrier Sense Errors
- Frame Too Long
- MAC Receive Errors
- Interface Counters
 - In Octets
 - In Ucast Packets
 - In NUCast Packets
 - In Discards
 - In Errors
 - In Unknown Protos
 - Out Octets
 - Out UCast Packets
 - Out NUCast Packets
 - Out Discards
 - Out Errors

Use the I/O Connections Page

To use the I/O Connections page for CIP I/O (Class 1) connection information, click I/O Connections tab at the top of the page or panel on the left. The I/O Connections page opens.

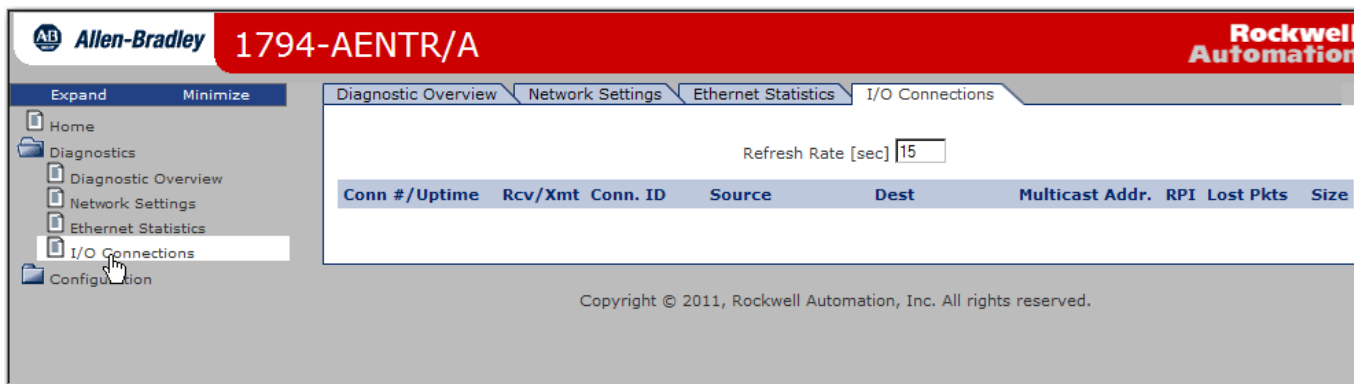

From the I/O Connections page, view the following:

- Connection Number / Uptime

- Received / Transmitted packets
- Connection ID
- Source
- Destination
- Multicast Address
- RPI
- Lost Packets
- Size

Work with the Configuration Pages

To work with the Configuration pages, follow these procedures.

IMPORTANT The values on these pages are in non-volatile memory. Changes to these parameters do not take effect until you reset or cycle power through the FLEX I/O adapter.

IMPORTANT If you set the value of the adapter switch to 888 and then power cycle the module, the following occurs:

- The DHCP Enabled function is enabled (set to True).
- The Ethernet link is negotiated automatically. The Auto Negotiate function is set to True.
- The web server is enabled. The Disabled Web Server function is disabled.
- The Ethernet port are disabled. Both ports are re-enabled once the switches are returned to their previous value and power is cycled.
- The password for this page resets to the factory default which is "<blank>".

Note the value of the switches before you enter the 888 value because you must return the adapter to those values once this process is complete.

1. From the Home page, click Configuration or Expand to see the Configuration options, if needed.
2. From the Configuration page, click one of the following:
 - Identity
 - Network
 - Services

A login dialog opens as shown. The dialog may vary in appearance depending on your operating system and browser.



3. From the user name and password dialog, enter values, noting the following:
 - The values for user name and password are case sensitive.
 - The default user name is "Administrator".
 - The default password is "<blank>".
4. Click OK to log in. After you log in, you can go to any of the Configuration pages without having to log in again.
5. Refer to the section of this manual that corresponds to the section you clicked:
 - Identity
 - Network Configuration
 - Services

Use the Device Identity Page

To use the Device Identity page to make entries for the device name, device description, and device location, click Device Identity from the tab at the top of the page or panel on the left.

The Identity page opens.

The screenshot shows a web interface for configuring an Allen-Bradley 1794-AENTR/A module. The page has a red header with the Allen-Bradley logo on the left and the Rockwell Automation logo on the right. Below the header, there are three tabs: Identity (selected), Network Configuration, and Services. On the left side, there is a navigation menu with options: Home, Diagnostics, Configuration (expanded), Identity (selected), Network, and Services. The main content area is titled "Device Information" and contains three input fields: "Host Name" with the value "1794-AENTR", "Module Description" with the value "1794-AENTR", and "Module Location" which is empty. Below these fields is an "Apply Changes" button. At the bottom of the page, there is a note: "Note: Special characters (eg. &, ?) are not supported. Values on this page are in non-volatile memory. Changes to these parameters do not take effect until the module has been reset or power cycled." and a copyright notice: "Copyright © 2011, Rockwell Automation, Inc. All rights reserved."

From the Identity page, complete entries for the following, noting that the description and location help you identify where modules are in the facility:

- Host Name
- Module Description
- Module Location

6. Click Apply Changes to save the modified values.

Use the Network Configuration Page

To use the Network Configuration page to make entries for enabling or disabling DHCP and setting TCP/IP parameters and Ethernet link operation, click Network Configuration tab at the top of the page or panel on the left.

The Network Configuration page opens.

The screenshot displays the Network Configuration page for an Allen-Bradley 1794-AENTR/A device. The page is organized into several sections:

- Initial Network Configuration:** Ethernet Interface Configuration is set to Static.
- Network Interface:** IP Address is 192.168.1.1, Subnet Mask is 255.255.255.0, Gateway Address is 0.0.0.0, Primary Name Server is 0.0.0.0, Secondary Name Server is 0.0.0.0, and Domain Name is empty.
- Ethernet Link Port 1:** Port 1 Enabled is Enabled, Autonegotiate Status is Autonegotiate Speed and Duplex, Select Port Speed is 100 Mbps, and Select Duplex Mode is Half Duplex.
- Ethernet Link Port 2:** Port 2 Enabled is Enabled, Autonegotiate Status is Autonegotiate Speed and Duplex, Select Port Speed is 100 Mbps, and Select Duplex Mode is Half Duplex.

An 'Apply Changes' button is located at the bottom of the configuration area. A note at the bottom states: "Note: Special characters (eg. &, ?) are not supported. Values on this page are in non-volatile memory. Changes to these parameters do not take effect until the module has been reset or power cycled." The copyright notice at the very bottom reads: "Copyright © 2011, Rockwell Automation, Inc. All rights reserved."

From the Network Configuration page, complete these entries, noting that values for Network Interface are disabled when DHCP is Dynamic DHCP and port speed and duplex mode are disabled when Autonegotiate Speed and Duplex is selected.

- For Initial Network Configuration:
 - Ethernet Interface Configuration
 - Static
 - Dynamic DHCP
- For Network Interface, fill out these fields:
 - IP Address
 - Subnet Mask
 - Gateway Address
 - Primary Name Server

- Secondary Name Server
 - Domain Name
 - For Ethernet Link Port 1 and Port 2, specify the following:
 - Autonegotiate Status
 - Autonegotiate Speed and Duplex
 - Force Speed and Duplex
 - Select Port Speed – 10 megabits, 100 megabits
 - Select Duplex Mode – Half Duplex, Full Duplex
7. From the Network Configuration page, click Apply Changes to save the modified values.

Use the Device Services Page

To use the Services page to change the password for the Configuration web page or disable the web server, click Device Services tab at the top of the page or panel on the left.

The Device Services page opens.

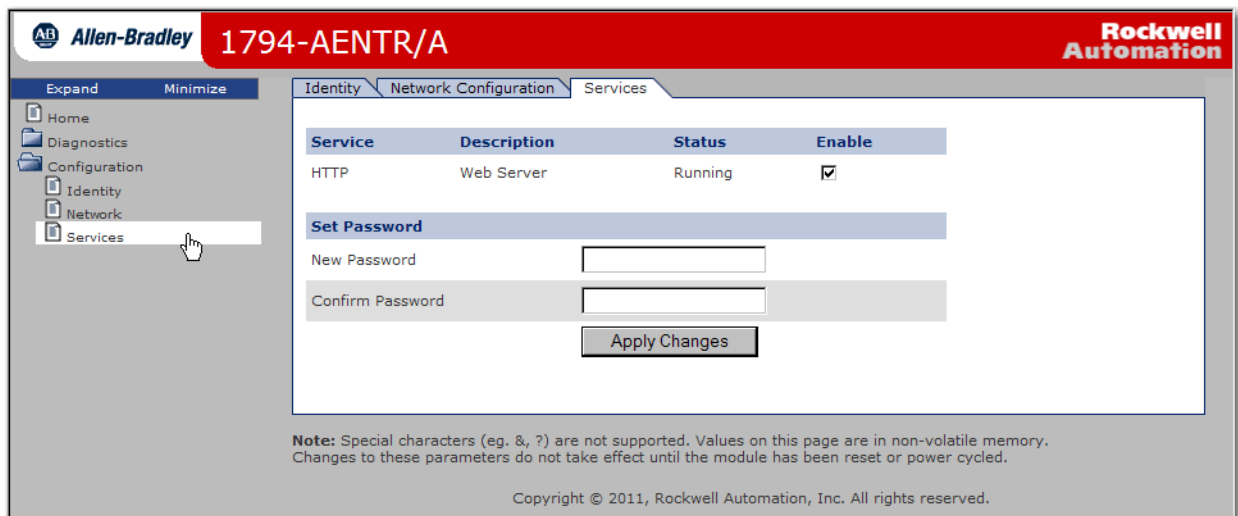

The screenshot shows the configuration interface for the Allen-Bradley 1794-AENTR/A device. The 'Services' tab is active, displaying a table of services and a password change section.

Service	Description	Status	Enable
HTTP	Web Server	Running	<input checked="" type="checkbox"/>

Set Password

New Password:

Confirm Password:

Note: Special characters (eg. &, ?) are not supported. Values on this page are in non-volatile memory. Changes to these parameters do not take effect until the module has been reset or power cycled.

Copyright © 2011, Rockwell Automation, Inc. All rights reserved.

From the Services page, make these entries.

- Click the Enable box to change whether the web server runs after the module is reset.
 - Change the password by typing a new value for New Password and Confirm Password, noting the following:
 - The entry is case sensitive.
 - The default value is <blank>.
8. Click Apply Changes.

Numerics

- 1756-EN2TR** 24, 38
 - module 28, 38
- 1756-EN2TR bridge** 27
- 1756-EN2TR module** 24, 28, 38
- 1794-IB16** 24

A

- AB_ETH** 35, 38, 48, 53, 54
 - configured 24
 - ethernet communication driver 53
- adapter** 1, 7
 - 1794-AENTR iii, 2, 3, 5, 7, 15, 23, 24, 26, 27, 28, 29, 30, 33, 37, 38, 40, 42, 45, 51, 53
 - 1794-AENTRXT iii, 2, 3, 5, 7, 15, 53
 - add 27
 - bridge 3
 - cabling components 2
 - child 27
 - CIP protocol 3
 - communicating through 5
 - compatibility 2
 - connect or disconnect 9
 - connection to 5
 - diagnostics 57
 - EDS file 59
 - Ethernet hardware address 15
 - faceplate 51
 - features 2
 - fixed network address 22
 - FLEX I/O iii, 1, 7
 - FlexBus 9
 - hook 8
 - install 7
 - IP address 22, 58
 - lock 10
 - module 2
 - mount 8, 9, 23
 - position 8
 - rack optimized 23
 - refers to 2
 - remove 9
 - remove or replace 8
 - replace 9
 - RPI 4, 5
 - RPI rate 5
 - subnet mask 12
 - support 4
 - unique IP address 15
 - web server dialog 57
 - wiring 8

adapter module 1

- address**
 - default 16
 - ethernet 19
 - Ethernet hardware 15
 - gateway 12, 15, 16
 - hardware 19
 - host ID 17
 - IP 2, 12, 15, 16, 53
 - MAC 17
 - network 12, 18, 22
 - node 12
- analog I/O module** 39

B

- BootP** 21
 - protocol 15
 - utility 15
- BootP utility** 15
- BootP/DHCP**
 - utility 18
- BootP/DHCP utility** 18
- bridge**
 - 1756-EN2TR 23, 27
- bridge module** 4
- bridging module** 3

C

- capacity**
 - module 2
- communicate** 1
 - programmable controllers 1
- communication driver** 24, 38
- compatibility**
 - hardware 2
 - software 2
- configuration**
 - device identity 65
 - identity 64
 - network 64
 - network configuration 66
 - services 64
- configuration data** 1
- configure**
 - 1756-EN2TR 27
 - AB_ETH driver 53
 - BootP/DHCP 18
 - digital I/O 37
 - direct communication 5
 - ethernet communications driver 53

- gateway 18
- gateway address 15
- IP address 15
- new adapter 15
- rack connection 23
- routing tables 3
- RPI 5
- RSLinx 24, 38
- subnet mask 15
- TCP/IP settings 57

configure driver

- window 55

connection

- adjacent 9
- backplane 9
- direct 4, 37, 41, 44
- I/O 58
- power wiring 9
- rack 41, 44
- rack optimized 4, 23
- single 5

connection point 9**connections**

- 8 4
- I/O 59

connector

- FlexBus 9

controller

- Logix5572 23

conventions iv**corresponding IP address 20****D****data 24**

- configuration 1, 4
- consumed 4
- exchange 4
- I/O 3, 5
- input 4
- messaging 3
- output 43
- produce 4
- read 23
- send 23
- transfer 4

data input 40**data transfer**

- real time 4

default address 16**description 20****device identity**

- host name 66

- module description 66
- module location 66

device services

- enable 68
- new password 68

DHCP 21**DHCP enabled 57****diagnostic overview 59****diagnostics**

- options 59

dimensions

- 1794-AENTR 13
- 1794-AENTRXT 13
- mounting 13

DIN rail 2, 7, 10, 23, 24, 37, 38

- mounting 2
- top-hat 8

direct connection 4**discrete**

- I/O modules 5

driver

- configure 55

duplex

- full 2
- half 2

dynamic allocation

- network address 22

E**EDS file**

- adapter 59

Electronic Keying 27**ethernet address (MAC) 19****Ethernet device 54****ethernet statistics 59**

- ethernet port 1 62
- ethernet port 2 62
- interface counters 63
- media counters 62

example

- direct connection 37
- rack optimized 23

F**faceplate**

- adapter 51

features

- adapter 2

firmware

- upgrades 2

FLEX I/O 23

- adapter 1
- description 1
- I/O module 1
- module components 7
- system 1
- terminal base 1

FLEX I/O module 2, 29**FLEX I/O system** 1

- components 1
- definition 1

FlexBus connector 9**G****gateway** 16**gateway address** 12, 15, 16

- configure 15

H**hardware**

- compatibility 2

hardware address 19**Host ID** 16**host ID address** 17**host name** 54**hostname** 20**I****I/O connections** 59

- connection ID 64
- connection number 63
- destination 64
- lost packets 64
- multicast addresss 64
- received packets 64
- RPI 64
- size 64
- source 64
- transmitted packets 64
- uptime 63

I/O data 3, 5

- real time 3

I/O module 1, 3, 4, 5, 8, 26**indicators**

- status 7, 51

input data 40**input module** 3, 23, 29**install**

- physically 7

Internet Protocol

- IP 12

invalid number

- thumbwheel switches 12

IP

- Internet Protocol 12

IP Address 19, 27**IP address** 2, 12, 15, 16, 17, 20, 53, 54, 57, 58

- adapter 22
- class 16
- configure 15
- corresponding 20
- dotted-decimal 16
- gateway 17
- retrieve 12
- switches 7
- unique 15, 16
- verify 24, 38

IP network 15**L****LED indicators**

- interpret 36

locking tab 10**M****MAC address** 17**manuals**

- related iv

messaging

- direct connection 4

module 8

- 1756-EN2TR 24, 26, 27
- 1794-IB16 23, 29, 30, 36
- 1794-IF4I 45
- 1794-OB16 23, 29, 32, 36
- 1794-OF4I 43
- adapter 1
- analog I/O 39
- analog input 39
- analog output 42
- bridge 4
- bridging 3
- capacity 2
- components 7
- configurations 29
- definition 28
- description 57
- digital input 23
- digital output 23
- dimensions 13

FLEX I/O 2, 29
 I/O 1, 3, 4, 5, 8, 26
 input 3, 23, 29, 37
 input, add 30
 insert or remove 9
 latching mechanism 9
 location 57
 locking tab 7
 name 57
 output 23, 29, 37
 output, add 31
 reinstall 10
 settings 60
 type 26
 uptime 60

module capacity 2

module description 57

module location 57

module name 57

module settings 60

module type 26

module uptime 60

modules

analog input 37
 analog output 37

N

Net ID 16

net ID 17, 18

network 3

cable 11
 devices 3
 EtherNet/IP 3, 4, 7
 scheduling 2
 TCP/IP 21
 traffic 3

network address 12, 18, 22

network cable 11

network configuration

ethernet link port 1 68
 ethernet link port 2 68
 initial 67
 network interface 67

network scheduling 2

network settings 59

ethernet interface configuration 61
 ethernet port 1 61
 ethernet port 2 61
 network interface 61

networking

consumer 3

node address 12

set 12

O

output data 43

output module 23, 29

overview

diagnostic 59

P

power supply 23

Protocol

Dynamic Host Configuration (DHCP) 12, 21
 Internet (IP) 12

protocol

application layer 3
 BootP 15
 CIP 3
 message based 3
 TCP/IP iii
 TCP/UDP/IP 2

publications

download iv
 related iv
 view iv

purpose of this manual iii

R

rack optimized

connection 23

real time

data transfer 4

refresh rate 59

RPI 41

RSLinx 38

S

settings

network 59

software

compatibility 2

statistics

ethernet 59

status

link 51
 module 51
 network 51

status indicators 7, 51

subnet mask

configure 15

switches

IP address 7

thumbwheel 12

T

TCP/IP

network 21

protocol iii

terminal base 1, 2, 9

adjacent 9, 10

unit 9

thumbwheel

settings 12

switches 12

thumbwheel switches

invalid number 12

read 12

transfer data 4

U

unique

48-bit hardware address 15

combination of bits 18

IP address 15, 52

unique IP address 15

W

web dialogs

CIP connection statistics 60

configuration 64

diagnostic overview 59, 60

ethernet statistics 59, 62

home page 57

I/O connections 59, 63

module settings 60

network settings 59, 61

password 65

ring status 60

system resource utilization 60

user name 65

web server 57

Rockwell Automation Support

Rockwell Automation provides technical information on the Web to assist you in using its products.

At <http://www.rockwellautomation.com/support/>, you can find technical manuals, a knowledge base of FAQs, technical and application notes, sample code and links to software service packs, and a MySupport feature that you can customize to make the best use of these tools.

For an additional level of technical phone support for installation, configuration, and troubleshooting, we offer TechConnect

support programs. For more information, contact your local distributor or Rockwell Automation representative, or visit <http://www.rockwellautomation.com/support/>.

Installation Assistance

If you experience a problem within the first 24 hours of installation, review the information that is contained in this manual.

You can contact Customer Support for initial help in getting your product up and running.

United States or Canada	1.440.646.3434
Outside United States or Canada	Use the Worldwide Locator at http://www.rockwellautomation.com/support/americas/phone_en.html , or contact your local Rockwell Automation representative.

New Product Satisfaction Return

Rockwell Automation tests all of its products to ensure that they are fully operational when shipped from the manufacturing facility. However, if your product is not functioning and needs to be returned, follow these procedures.

United States	Contact your distributor. You must provide a Customer Support case number (call the phone number above to obtain one) to your distributor to complete the return process.
Outside United States	Please contact your local Rockwell Automation representative for the return procedure.

Documentation Feedback

Your comments will help us serve your documentation needs better. If you have any suggestions on how to improve this document, complete this form, publication [RA-DU002](#), available at <http://www.rockwellautomation.com/literature/>.

Rockwell Otomasyon Ticaret A.Ş., Kar Plaza İş Merkezi E Blok Kat:6 34752 İçerenköy, İstanbul, Tel: +90 (216) 5698400

www.rockwellautomation.com

Power, Control and Information Solutions Headquarters

Americas: Rockwell Automation, 1201 South Second Street, Milwaukee, WI 53204-2496 USA, Tel: (1) 414.382.2000, Fax: (1) 414.382.4444

Europe/Middle East/Africa: Rockwell Automation NV, Pegasus Park, De Kleetlaan 12a, 1831 Diegem, Belgium, Tel: (32) 2 663 0600, Fax: (32) 2 663 0640

Asia Pacific: Rockwell Automation, Level 14, Core E, Cyberport 3, 100 Cyberport Road, Hong Kong, Tel: (852) 2887 4788, Fax: (852) 2508 1846

Publication 1794-UM066B-EN-E - March 2015

Supersedes Publication 1794-UM066A-EN-P - February 2012

Copyright © 2015 Rockwell Automation, Inc. All rights reserved.