

1734 POINT I/O and 1738 ArmorPOINT I/O Dual Port EtherNet/IP Adapters

Catalog Numbers 1734-AENTR, Series C and 1738-AENTR, Series B



Important User Information

Solid-state equipment has operational characteristics differing from those of electromechanical equipment. Safety Guidelines for the Application, Installation and Maintenance of Solid State Controls (publication [SGL-1.1](#) available from your local Rockwell Automation sales office or online at <http://www.rockwellautomation.com/literature/>) describes some important differences between solid-state equipment and hard-wired electromechanical devices. Because of this difference, and also because of the wide variety of uses for solid-state equipment, all persons responsible for applying this equipment must satisfy themselves that each intended application of this equipment is acceptable.

In no event will Rockwell Automation, Inc. be responsible or liable for indirect or consequential damages resulting from the use or application of this equipment.

The examples and diagrams in this manual are included solely for illustrative purposes. Because of the many variables and requirements associated with any particular installation, Rockwell Automation, Inc. cannot assume responsibility or liability for actual use based on the examples and diagrams.

No patent liability is assumed by Rockwell Automation, Inc. with respect to use of information, circuits, equipment, or software described in this manual.

Reproduction of the contents of this manual, in whole or in part, without written permission of Rockwell Automation, Inc., is prohibited.

Throughout this manual, when necessary, we use notes to make you aware of safety considerations.



WARNING: Identifies information about practices or circumstances that can cause an explosion in a hazardous environment, which may lead to personal injury or death, property damage, or economic loss.



ATTENTION: Identifies information about practices or circumstances that can lead to personal injury or death, property damage, or economic loss. Attentions help you identify a hazard, avoid a hazard, and recognize the consequence



SHOCK HAZARD: Labels may be on or inside the equipment, for example, a drive or motor, to alert people that dangerous voltage may be present.



BURN HAZARD: Labels may be on or inside the equipment, for example, a drive or motor, to alert people that surfaces may reach dangerous temperatures.

IMPORTANT Identifies information that is critical for successful application and understanding of the product.

Allen-Bradley, ArmorPOINT, ControlLogix, Logix5000, Logix 5000, POINT Guard I/O, POINT I/O, POINTBus, Rockwell Automation, Rockwell Software, RSLogix, RSLogix 5000, RSLinx, Studio 5000, Studio 5000 Logix Designer, and TechConnect are trademarks of Rockwell Automation, Inc.

CIP and EtherNet/IP are trademarks of ODVA, Inc.

Trademarks not belonging to Rockwell Automation are property of their respective companies.

This manual contains new and updated information. Changes throughout this revision are marked by change bars, as shown to the right of this paragraph.

New and Updated Information

This table contains the changes made to this revision.

Topic	Page
Updated POINT I/O EtherNet/IP adapters to Series C	throughout

Notes:

Summary of Changes	New and Updated Information.....	iii
Table of Contents		
Preface	Who Should Use this Manual.....	ix
	Purpose of this Manual.....	ix
	Related Documentation.....	ix
	Common Techniques Used in this Manual.....	x
	Studio 5000 Environment.....	x
	Chapter 1	
Overview of the 1734 POINT and 1738 ArmorPOINT EtherNet/IP Adapters	Overview.....	1
	Adapter Features.....	1
	What the Adapter Does.....	2
	Physical Features of Your Adapters.....	3
	Types of Modules.....	4
	Hardware/Software Compatibility.....	4
	Important Adapter Considerations.....	4
	1734-AENTR Adapter Thumbwheel Settings.....	5
	Set the Chassis Size.....	5
	Set the Chassis Size by Using the Thumbwheels on the 1734-AENTR Adapter.....	6
	Adapter Replacement.....	7
	Empty Slots and RIUP Situations.....	8
	Power Up a System for the First Time.....	9
	Use of the Common Industrial Protocol (CIP).....	9
	Understand the Producer/Consumer Model.....	9
	Specify the Requested Packet Interval (RPI).....	10
	Support for Rack-optimization, Enhanced Rack-optimization, and Direct Connections.....	10
	Mixing Rack-optimization, Enhanced Rack-optimization, and Direct Connections.....	11
	Chapter Summary.....	11
	Chapter 2	
Install Your POINT I/O or ArmorPOINT I/O Adapter	Overview.....	13
	Mount the POINT I/O Adapter on a DIN Rail.....	14
	Install POINT I/O Modules.....	15
	Remove POINT I/O Modules.....	15
	Mount the ArmorPOINT I/O Adapter on a Panel or Wall.....	16
	Install ArmorPOINT I/O Modules.....	17
	Remove ArmorPOINT I/O Modules.....	18
	Replace An Adapter.....	19

Wire the Adapter.....	20
Wire a POINT I/O Adapter.....	20
Wire an ArmorPOINT I/O Adapter.....	22
Chapter Summary.....	22

Chapter 3

Configure the Adapter with RSLogix 5000 or Logix Designer Software

Introduction.....	23
Configuration Requirements.....	24
IP Address.....	24
Gateway Address.....	25
Subnet Mask.....	26
Set the Network Address.....	27
Set the Network Address for POINT I/O Adapters.....	27
Set the Network Address for ArmorPOINT I/O Adapters.....	28
Use the Rockwell BootP/DHCP Server tool.....	29
Save the Relation List.....	32
Use DHCP Software to Configure Your Adapter.....	33
Chapter Summary.....	33

Chapter 4

Configure the Adapter for Direct Connection in RSLogix 5000 or Logix Designer Software

Overview.....	35
Set Up the Hardware.....	36
Create the Example Application.....	37
Configure the I/O Modules.....	38
Add the Local EtherNet/IP Bridge to the I/O Configuration.....	39
Add the POINT I/O Adapter to the I/O Configuration.....	42
Add the POINT I/O Modules to the I/O Configuration.....	45
Add the Digital Relay Output Module.....	45
Add the Digital Output Module.....	48
Edit the Controller Tags.....	51
Create the Ladder Program.....	52
Download the Program to the Controller.....	52
Verify the Module Chassis Size.....	53
Configure the Adapter with Fixed IP Address.....	56
Recover From an Overloaded Adapter.....	57
Chapter Summary.....	57

Chapter 5

Configure the Adapter for Direct Connection, Rack Optimization, and Enhanced Rack Optimization in RSLogix 5000 or Logix Designer Software	Overview	59
	Set Up the Hardware	60
	Set Up the POINT I/O Hardware	60
	Create the Example Application	61
	Configure the I/O Modules	62
	Add the Local EtherNet/IP Bridge to the I/O Configuration	62
	Add the POINT I/O Adapter to the I/O Configuration	65
	Add the POINT I/O Modules and Configure for Rack-optimization Connection	69
	Add the Digital Relay Output Module	69
	Add the POINT I/O Modules and Configure for Enhanced Rack-optimization Connection	73
	Add the Digital Relay Output Module	73
	Add the POINT I/O Module and Configure For Direct Connection	76
	Add The Digital Sink Output Module	76
	Download the Program to the Controller	79
	Verify the Module Chassis Size	80
	Access Module Data	83
Chapter Summary	83	
 Chapter 6		
Troubleshoot the Adapter	Interpret the Status Indicators	85
	Status Indicators for POINT I/O Adapters	85
	Status Indicators for ArmorPOINT I/O Adapters	88
 Appendix A		
Specifications	General Specifications	91
	Power Supply	93
	EtherNet Communication	93
	Environmental Specifications	94
 Appendix B		
Adapter Web Dialogs	Overview	97
	Work with the Home Page	97
	Work with the Diagnostics Pages	99
	Use the Diagnostic Overview Page	100
	Use the Network Settings Page	101
	Use the Ethernet Statistics Page	102
	Use the I/O Connections Page	104
Use the Advanced Diagnostics Page	105	

Work with the Configuration Pages.....	106
Use the Identity Page	108
Use the Network Configuration Page	109
Use the Services Page.....	110
Work with the Browse Chassis Page.....	111

Appendix C

Configure the RSLinx Ethernet Communication Driver

Overview	113
Install the RSLinx Software	113
Configure the AB_ETH Driver	114
Configure the AB_ETHIP Driver	116

Index

Read this preface to familiarize yourself with the rest of the manual. It provides information concerning:

- who should use this manual
- the purpose of this manual
- related documentation
- conventions used in this manual

Who Should Use this Manual

Use this manual if you are responsible for designing, installing, programming, or troubleshooting control systems that use 1734 POINT I/O™ or 1738 ArmorPOINT® I/O Dual Port EtherNet/IP Adapter Modules.

Purpose of this Manual

This manual is a reference guide for the 1734-AENTR, Series C and 1738-AENTR, Series B POINT I/O Dual Port EtherNet/IP and ArmorPOINT I/O Dual Port EtherNet/IP Adapters, communications adapters for POINT I/O modules. It describes the procedures you use to install, wire, configure, troubleshoot, and use your module.



ATTENTION: Check the Product Compatibility and Download Center (PCDC) to verify the compatibility between your POINT I/O module and the POINT I/O adapter.

Related Documentation

The following documents contain additional information concerning Rockwell Automation products. To obtain a copy, contact your local Rockwell Automation office or distributor.

Resource	Description
1734 POINT I/O Selection Guide, publication 1734-SG001	A description and overview of the 1734 series I/O modules and compatible control platforms.
EtherNet/IP Design Considerations Reference Manual, publication ENET-RM002 .	Using EtherNet/IP for Industrial Control.
EtherNet/IP Modules in Logix5000™ Control Systems User Manual, publication ENET-UM001	A manual describing how to use EtherNet/IP modules with Logix5000 controllers and communicate with various devices on the Ethernet network.
EtherNet/IP Embedded Switch Technology Application Guide, publication ENET-AP005	Describes how to install, configure, and maintain linear and device-level Ring (DLR) networks using Rockwell Automation EtherNet/IP devices with embedded switch technology.
ControlLogix® Chassis and Power Supplies Installation Instructions, publication 1756-IN005 .	Describes how to install and troubleshoot standard and ControlLogix-XT versions of the 1756 chassis and power supplies, including redundant power supplies.
ControlLogix EtherNet/IP Bridge Module Installation Instructions, publication 1756-IN019	ControlLogix EtherNet/IP Bridge Module installation instructions.
ControlLogix System User Manual, publication 1756-UM001	Detailed information on how to install, configure and troubleshoot the ControlLogix Sequence of Events module in your ControlLogix application.

Resource	Description
RSLinx® Classic Getting Results Guide, publication LINX-GR001	Information on how to install and navigate the RSLinx Classic software. It explains how to access and navigate the help, and how to effectively use the RSLinx Classic software.
1734 POINT I/O Dual Port EtherNet/IP Adapter Installation Instructions, publication 1734-IN041	Installation instructions for installing the 1734 POINT I/O Dual Port EtherNet/IP Adapter.
1738 ArmorPOINT I/O Dual Port EtherNet/IP Adapter Installation Instructions, publication 1738-IN030	Installation instructions for installing the 1738 ArmorPOINT I/O Dual Port EtherNet/IP Adapter.
Pinout Guide for 1738 ArmorPOINT Adapters and Power Supplies Wiring Diagram, publication 1738-WD011	Information on wiring 1738 ArmorPOINT I/O EtherNet/IP Series B Adapters and Power Supplies.
Allen-Bradley Industrial Automation Glossary, publication AG-QR071	A glossary of industrial automation terms and abbreviations.
Industrial Automation Wiring and Grounding Guidelines, publication 1770-IN041 .	Detailed information on proper wiring and grounding techniques.
EtherNet/IP Media Planning and Installation Manual (ODVA).	Describes the required media components and how to plan for, install, verify, troubleshoot, and certify an Ethernet network.
Product Compatibility and Download Center (PCDC) http://compatibility.rockwellautomation.com/Pages/home.aspx	The Product Compatibility and Download Center (PCDC) helps you find product-related downloads including firmware, release notes, associated software, drivers, tools and utilities.

Common Techniques Used in this Manual

The following conventions are used throughout this manual:

- Bulleted lists such as this one provide information, not procedural steps.
- Numbered lists provide sequential steps or hierarchical information.
- *Italic* type is used for emphasis.

Rockwell Software products contain extensive tutorials and help screens. We recommend that you use these tutorials and help screens to learn about the products.

For more information about Rockwell Software products, visit the Rockwell Software website at <http://www.rockwellautomation.com/software/>.

Studio 5000 Environment

The Studio 5000 Automation Engineering & Design Environment® combines engineering and design elements into a common environment. The first element is the Studio 5000 Logix Designer® application. The Logix Designer application is the rebranding of RSLogix 5000® software and will continue to be the product to program Logix5000™ controllers for discrete, process, batch, motion, safety, and drive-based solutions.



The Studio 5000® environment is the foundation for the future of Rockwell Automation® engineering design tools and capabilities. The Studio 5000 environment is the one place for design engineers to develop all elements of their control system.

Notes:

Overview of the 1734 POINT and 1738 ArmorPOINT EtherNet/IP Adapters

Overview

This chapter provides an overview of the POINT I/O, Series C and ArmorPOINT I/O Dual Port EtherNet/IP adapters, their primary features, and how to use them. You need to understand the concepts discussed in this chapter to configure your adapter and use it in an EtherNet/IP control system.

The following table lists where to find specific information.

Topic	Page
Adapter Features	1
What the Adapter Does	2
Physical Features of Your Adapters	3
Types of Modules	4
Hardware/Software Compatibility	4
Important Adapter Considerations	4
Set the Chassis Size	5
Adapter Replacement	7
Empty Slots and RIUP Situations	8
Power Up a System for the First Time	9
Use of the Common Industrial Protocol (CIP)	9
Understand the Producer/Consumer Model	9
Specify the Requested Packet Interval (RPI)	10
Support for Rack-optimization, Enhanced Rack-optimization, and Direct Connections	10
Mixing Rack-optimization, Enhanced Rack-optimization, and Direct Connections	11
Chapter Summary	11

Adapter Features

The POINT I/O and ArmorPOINT I/O adapters provide connectivity to EtherNet/IP networks for POINT I/O and ArmorPOINT I/O modules respectively.

The POINT I/O adapter is for the I/O backplane that provides connectivity through two RJ-45 connectors for 2-port pass-through support of daisy chain or ring, and the existing star and tree network topologies.

The ArmorPOINT I/O adapter provides connectivity through two M12 Ethernet-keyed connectors. It ships with a terminating base for use in the last I/O module on the backplane.

Some of the module's features are as follows:

- Use of EtherNet/IP messages encapsulated within standard TCP/UDP/IP protocol
- Common application layer with ControlNet and DeviceNet networks
- Interfacing via Category 5 rated twisted pair cable
- Half/full duplex 10 Mbit or 100 Mbit operation
- DIN rail mounting for 1734-AENTR adapter/Wall or panel mounting for 1738-AENTR adapter
- Communication to and from other I/O modules on the same DIN rail for 1734-AENTR adapter/Communication to and from other I/O modules in the chassis for 1738-AENTR adapter
- Communication supported by RSLinx® software
- IP address assigned via Rockwell BOOTP/DHCP server or other standard DHCP tools
- I/O configuration via RSLogix 5000 or Logix Designer software
- No network scheduling required
- No routing tables required
- Support of connections from multiple controllers simultaneously

You must use RSLogix 5000 or Logix Designer to configure these features. For more details on configuration, see [Configuration Requirements](#) in chapter 3.

What the Adapter Does

The I/O adapters perform the following primary tasks:

- Control of real-time I/O data (also known as implicit messaging) - the adapter serves as a bridge between I/O modules and the network

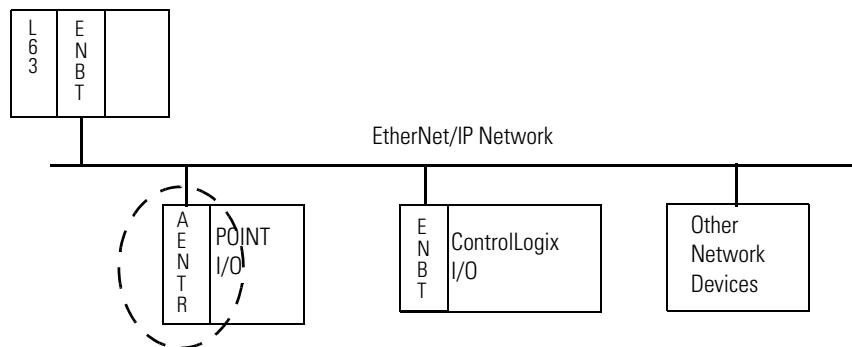

- Support of messaging data for configuration and programming information (also known as explicit messaging)
- Support of Output hold in all output modules during Program mode and Fault mode. Note that the option is not available for Program Download mode.

Physical Features of Your Adapters

The 1734 Adapters have the following components:

- Removable Terminal Block (RTB);
- Network address thumbwheel
- Connectors (two RJ45 EtherNet/IP connectors)
- Status indicators (Module Status; Network Status; POINTBus Status; Network Activity; Link 1 Activity/Status; Link 2 Activity/Status; System Power; Field Power)

Physical Features of the 1734-AENTR Adapters

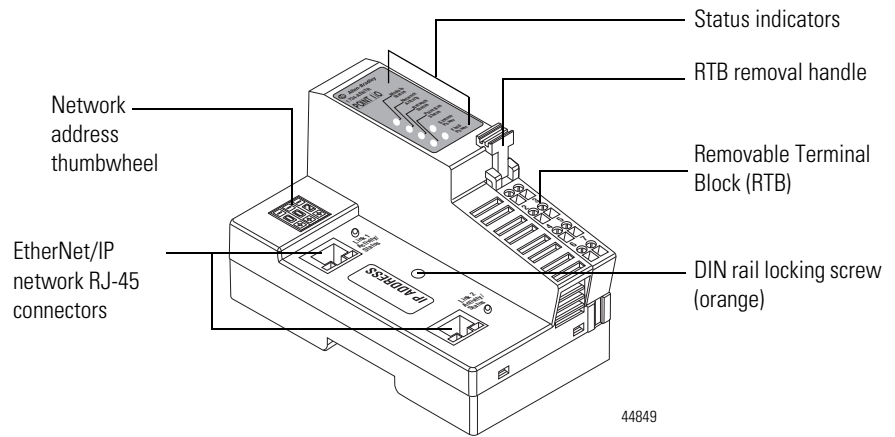

The 1738 Adapters have the following components:

- Network address Switches
- Two EtherNet/IP Female M12 connectors
- Mini Style 4-Pin in Male Connector
- Status indicators (Module Status; Network Status; POINTBus Status; Network Activity; Link 1 Activity/Status; Link 2 Activity/Status; System Power; Adapter Power)

Physical Features of the 1738-AENTR Adapters

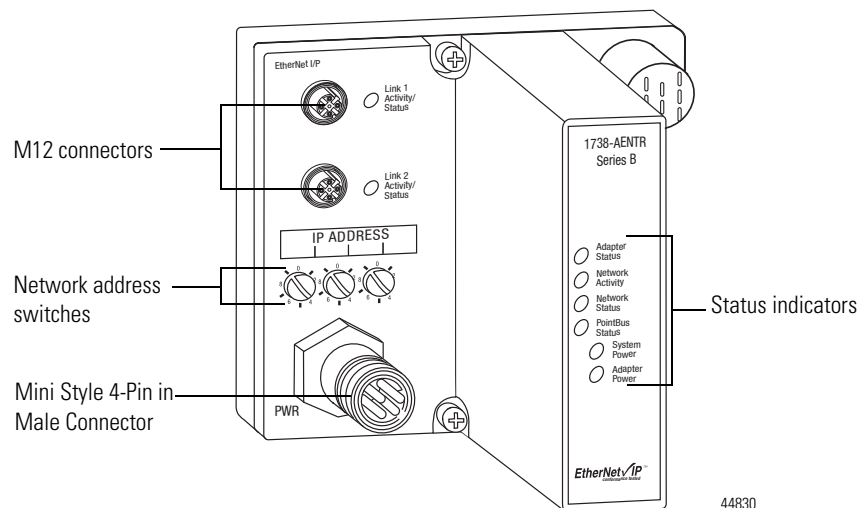

Types of Modules

The types of Adapters are as follows.

Catalog Number	Description	Network Connector	Power Connector
1734-AENTR	24V DC power, Dual-Port EtherNet/IP Module	Dual RJ-45	-
1738-AENTR	24V DC power, Dual-Port ArmorPOINT EtherNet/IP Module	D-code M12	Mini Style 4-Pin in Male

Hardware/Software Compatibility

The I/O adapters and the applications described in this manual are compatible with the following firmware revisions and software releases.

Contact Rockwell Automation if you need software or firmware upgrades to use this equipment

Product	Firmware Revision/ Software Release ⁽²⁾
1734-AENTR Series C adapter	6.011 or later
1738-AENTR Series B adapter	4.002 or later
1756-ENBT	4.006 or later
1768-ENBT	2.003 or later
Logix controller	17 or later
RSLogix 5000 software ⁽¹⁾	17 or later
RSLinx software	2.56 or later

(1) From version 21 onwards, RSLogix 5000 is know as Logix Designer.

(2) Installation of the Add-on Profile (AOP) for the adapter is required.

The Enhanced Rack-Optimization option is only supported in the following.

Product	Firmware Revision/ Software Release ⁽²⁾
1734-AENTR Series C adapters	6.011 or later
Logix controller	20 or later
RSLogix 5000 software ⁽¹⁾	20 or later
RSLinx software	2.56 or later

(1) From version 21 onwards, RSLogix 5000 is know as Logix Designer.

(2) Installation of the Add-on Profiles (AOP) for the adapter and I/O module are required.

Important Adapter Considerations

Before you begin using your adapter, note the following important considerations.



ATTENTION: Check the Product Compatibility and Download Center (PCDC) to verify the compatibility between your POINT I/O module and the POINT I/O adapter.

1734-AENTR Adapter Thumbwheel Settings

You can set the thumbwheels on the 1734-AENTR adapter to perform different functions. Refer to the following table to see the valid thumbwheel settings and the corresponding function.

Setting	Function
001...254	Sets the network address. Refer to Set the Network Address on page 27 for more information.
801...864	Sets the chassis size. Refer to Set the Chassis Size by Using the Thumbwheels on the 1734-AENTR Adapter on page 6 for more information.
888	Restores default factory settings.

If the thumbwheels are set to an invalid number, the adapter checks to see if DHCP is enabled. If DHCP is enabled, the adapter requests an address from a DHCP server. The DHCP server also assigns other Transport Control Protocol (TCP) parameters.

Set the Chassis Size

The I/O adapters for EtherNet/IP require configuration of their chassis size before you can make any I/O connections. The factory default setting for the chassis size is one slot, which represents the adapter by itself.

You must set the chassis size to a number equaling one slot for the adapter plus one slot for each I/O module present in the backplane of the adapter.

For example, if your system consists of one adapter and four I/O modules, set the chassis size to 5.

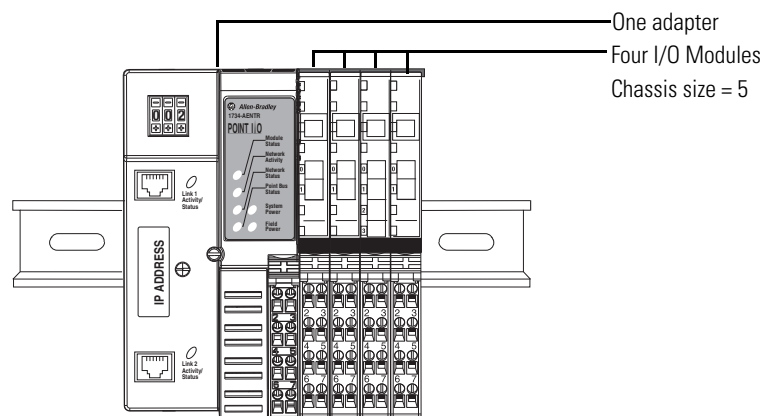

The adapter stores this chassis size setting in non-volatile memory.

Each time the adapter is powered up, the adapter compares the number of I/O modules present on its backplane to the chassis size value from non-volatile

memory. The adapter does not allow any I/O connection until the number of I/O modules present equals the chassis size value minus one for the adapter itself.

You can set the chassis size by using the following:

Tool	Description
Studio 5000 Logix Designer application Add-on Profile	Refer to Add the POINT I/O Adapter to the I/O Configuration on page 42 and Verify the Module Chassis Size on page 53 for more information.
RSLinx Classic software, version 3.70 or later	Log on to http://www.rockwellautomation.com/knowledgebase and search for information on changing or configuring the chassis size of POINT I/O adapters.
Web dialog	Refer to for Use the Identity Page on page 108 more information.
Thumbwheels (1734-AENTR adapter only, firmware revision 5.015 or later)	Refer to Set the Chassis Size by Using the Thumbwheels on the 1734-AENTR Adapter on page 6 for more information.

Set the Chassis Size by Using the Thumbwheels on the 1734-AENTR Adapter

For firmware revision 5.015 or later, you can set the chassis size without a computer by using the thumbwheels on the 1734-AENTR adapter.

1. Make sure that the adapter is not powered.
2. Set the thumbwheels to 8xx where xx is the chassis size value from 01...64.

For example, set the thumbwheels to 802 to set the chassis size to 2, 803 to set the chassis size to 3, and so on up to 864 to set the chassis size to 64.

TIP Press a pen tip into the center and perpendicular to the + or the - button to change the number. You only need a small amount of force to press the button (approximately 2N).

3. Power up the adapter.
4. Observe the status indicators.

The following table describes the status indicators of the adapter when the adapter is powered up while the thumbwheels are set a value from 801...864:

Indicator	Status
Module Status	Flashing red
Network Activity	Off
Network Status	Off
POINTBus Status	<p>The POINTBus Status indicator flashes red initially and then either changes to solid green or continues to flash red depending on the connection result.</p> <ul style="list-style-type: none"> • Solid green – if the configured chassis size and number of physical nodes present match • Flashing red – if the configured chassis size and number of physical nodes present do not match

Note: Communication on all Ethernet ports are disabled while the thumbwheels are set to 8xx.

5. If the POINTBus Status indicator changes to solid green, skip to Step 9.
6. If the POINTBus Status indicator continues to flash red, determine the cause of the error.

The cause of error may be one of the following:

Indicator	Status
Chassis size mismatch	<p>Make sure that the chassis size value matches the total number of the adapter plus the I/O modules.</p> <p>For example, if you have 1 adapter and 10 I/O modules, then the chassis size is 11. Therefore, the thumbwheels must be set to 811.</p>
Module fault	Refer to the installation instructions publication for the affected module for information on how to interpret its status indicators.

7. Remove power from the adapter and then address the error accordingly.
8. Once you have addressed the error, repeat Steps 1...5.
9. Once you have set the chassis size by using the thumbwheels, remove power from the adapter and then set the thumbwheels according to the IP address setting that you need.

For more information, see [Set the Network Address for POINT I/O Adapters on page 27](#).

Adapter Replacement

Note that during a connection request from the controller, the chassis size setting is not communicated to the adapter. You must always set this chassis size using a separate operation. This includes situations when you are replacing an adapter. The adapter does not allow any I/O connections until it is configured with the appropriate chassis size and the proper number of POINT I/O or ArmorPOINT I/O modules are present.

Empty Slots and RIUP Situations

The POINT I/O system cannot detect an empty terminal base. For this reason, there are numerous situations in which you can potentially configure a system that is unusable or one that exercises unintended control.

In an attempt to address these situations, you must observe the following rules for I/O system construction and the removal and reinsertion of modules.

- A correct I/O system does not have any empty terminal bases.
- After you cycle power, the adapter will not allow any I/O connections until the number of modules comprising the chassis plus one for the adapter equals the stored chassis size.
 - It cannot assume any safe operation until there is a match between the number of modules indicating their presence in the chassis and what the adapter has saved in non-volatile memory because it cannot detect empty terminal bases.
 - Actual module identification (such as, electronic keying) is done when connection establishment requests are received from the controller or controllers.
- A POINT I/O module removed under power does not disrupt operation of the other I/O modules. On the other hand, ArmorPOINT I/O modules are not intended to be removed under power.
 - When you remove a module, the adapter detects what changed.
 - Whenever you remove a module with an active connection from the POINT I/O system, the adapter indicates this by flashing the POINTBus Status LED red and reports a minor recoverable fault.
- If more than one contiguous module is removed under power, connections to all modules in the contiguous missing module set are disallowed until all modules are replaced. Because the adapter cannot detect an empty base, it does not know the physical positioning of the modules until all the missing modules are replaced.
- If a module separating two sets of contiguous missing modules is removed, the two sets merge into a single set. All the modules must be replaced before connections are permitted to any module in the set.
- If modules of different types are removed and returned to the wrong locations, attempts to connect to these modules will fail during verification of the electronic ID (providing that keying has not been disabled).
- If modules of the same type are removed and returned to the wrong locations, they accept connections from the controller or controllers and reconfigure with the correct data once they pass their electronic keying check.
- These removal and return situations exist whether the system is under power or not. If the system is under power, the situation arises immediately. If the system is not under power, the situation arises in the next power cycle.

Power Up a System for the First Time

When you power the I/O for the first time, the adapter must assign slot addresses to every module in the backplane. All I/O modules ship configured at the same address.

When you first apply power, we expect that all but one module on the backplane exhibits a solid red Module Status LED.

One by one the adapter resets these modules and addresses them appropriately. The amount of time that this operation takes is proportional to the size of your I/O system.

Use of the Common Industrial Protocol (CIP)

The adapter uses the Common Industrial Protocol (CIP). CIP is the application layer protocol specified for EtherNet/IP, the Ethernet Industrial Protocol, as well as for ControlNet and DeviceNet networks. It is a message-based protocol that implements a relative path to send a message from the producing device in a system to the consuming devices.

The producing device contains the path information that steers the message along the proper route to reach its consumers. Since the producing device holds this information, other devices along the path simply pass this information; they do not store it.

This has the following significant benefits:

- You do not need to configure routing tables in the bridging modules, which greatly simplifies maintenance and module replacement.
- You maintain full control over the route taken by each message, which enables you to select alternative paths for the same end device.

Understand the Producer/Consumer Model

The CIP producer and consumer networking model replaces the old source and destination (master and slave) model. The producer and consumer model reduces network traffic and increases speed of transmission. In traditional I/O systems, controllers poll input modules to obtain their input status. In the CIP system, input modules are not polled by a controller. Instead, they produce (multicast or unicast) their data either upon a change of state (COS) or periodically.

Multicast is the default mode for version 17 Logix and earlier controllers and unicast is the default for version 18 with multicast as a selectable option.

The frequency of update depends upon the options chosen during configuration and where on the network the input module resides. The input module, therefore, is a producer of input data, and the controller is a consumer of the data.

The controller also produces data for other controllers to consume. The produced and consumed data is accessible by multiple controllers and other devices over the EtherNet/IP network. This data exchange conforms to the producer and consumer model.

Specify the Requested Packet Interval (RPI)

The Requested Packet Interval or RPI is the update rate specified for a particular piece of data on the network. The RPI can be specified for the adapter and include all of the I/O modules in the I/O system (using a rack-optimization or enhanced rack-optimization⁽¹⁾ connection) or specified for a particular module (using direct connection).

When you add a module or an adapter to the I/O configuration of a controller, you must enter the RPI as a parameter. This value specifies how often to produce the data for that device. For example, if you specify an RPI of 50 ms, it means that every 50 ms the device should send its data to the controller and the controller should send the consumed (output) data to the device.

Use RPIs only for devices that exchange data. For example, a ControlLogix® EtherNet/IP bridge module in the same chassis as the controller does not require an RPI, because it is not a data-producing member of the system. Its use is only as a bridge to remote racks.

(1) Enhanced rack-optimization connections are only supported by the 1734 adapter.

Support for Rack-optimization, Enhanced Rack-optimization, and Direct Connections

The I/O adapters supports direct, rack-optimization and enhanced rack-optimization⁽¹⁾ connections. A direct connection is a real-time data transfer link between the controller and the module occupying the slot that the configuration data references.

Direct I/O connections occur at a cyclic rate specified by the RPI during configuration. A rack-optimization connection is a grouping of data from one or more digital I/O modules into a single block of data sent over a single connection at the same data rate.

Analog, safety, and specialty modules cannot participate in the rack-optimization connection; these modules require an enhanced rack-optimization⁽¹⁾ or direct I/O connection.

Enhanced rack-optimization connections reduce the total number of connections needed to transfer data when using many digital and analog, or specialty modules in a system.

Rack-optimization connections reduce the total number of connections needed to transfer data when using many digital I/O modules in a system. The following example illustrates the benefit of rack-optimization connections.

Assume you set up a system that contains eight digital I/O modules interfaced to an adapter. If you use direct connections to transfer data to each of these I/O modules, you need eight connections to transfer all of the data, one to each of the eight I/O modules. If you use a rack-optimization connection to transfer the data, you only need a single connection – the connection to the I/O adapter.

IMPORTANT

Although rack-optimization and enhanced rack-optimization connections offer an efficient way to use resources, there are a few limitations on their use:

- You can use only rack-optimization or enhanced rack-optimization connections to send data to and from digital I/O modules.
 - Safety modules, IO link module, and third-party I/O modules can not participate in enhanced rack-optimization connections.
 - Enhanced rack-optimization does not support a listen only connection. Do not use enhanced rack-optimization if your application requires a connection for monitoring.
 - All data is sent at the same time as the RPI rate of the I/O adapters. If the update rate required for a digital module is different from the RPI of the rack-optimization or enhanced rack-optimization connection, a direct connection to that I/O module is required.
-

See the EtherNet/IP Embedded Switch Technology Application Guide, publication [ENET-AP005](#), for more information on connections.

(1) Enhanced rack-optimization connections are only supported by the 1734 adapter.

Mixing Rack-optimization, Enhanced Rack-optimization, and Direct Connections

You can mix communication formats for different I/O modules communicating through the same adapter. I/O modules set up to use rack-optimization or enhanced rack-optimization⁽¹⁾ communicate at the rate of the RPI configured for the adapter. I/O modules configured for direct communication communicate at their own individual RPIs and ignore the rack-optimization RPI.

(1) Enhanced rack-optimization connections are only supported by the 1734 adapter.

Chapter Summary

In this chapter, you were introduced to the features of the POINT I/O and ArmorPOINT I/O Adapters, and considerations for installation and usage.

Notes:

Install Your POINT I/O or ArmorPOINT I/O Adapter

Overview

This chapter describes how to physically install the POINT I/O Series C and ArmorPOINT I/O Dual Port EtherNet/IP adapters; and how to connect the adapter to the EtherNet/IP network.

This chapter includes the following topics:

Topic	Page
Mount the POINT I/O Adapter on a DIN Rail	14
Install POINT I/O Modules	15
Remove POINT I/O Modules	15
Mount the ArmorPOINT I/O Adapter on a Panel or Wall	16
Install ArmorPOINT I/O Modules	17
Remove ArmorPOINT I/O Modules	18
Replace An Adapter	19
Wire a POINT I/O Adapter	20
Wire an ArmorPOINT I/O Adapter	22
Chapter Summary	22



ATTENTION: Check the Product Compatibility and Download Center (PCDC) to verify the compatibility between your POINT I/O module and the POINT I/O adapter.



ATTENTION: To comply with the CE Low Voltage Directive (LVD), this equipment must be powered from a source compliant with the following: Safety Extra Low Voltage (SELV) or Protected Extra Low Voltage (PELV).

Mount the POINT I/O Adapter on a DIN Rail

10. Make sure the DIN rail locking screw (orange) is in horizontal position.
11. Position the adapter vertically above an IEC standard (35 x 7.5 x 1 mm) top-hat DIN rail at a slight angle (DIN rail: Allen-Bradley part number **199-DR1; 46277-3**).
12. Press down firmly to install the adapter on the DIN rail, noting that the locking mechanism locks the adapter to the DIN rail.



ATTENTION: Allow 25.4 mm (1.0 in.) of space between adjacent equipment for adequate ventilation.

13. Set the network address thumbwheel switches to the desired value. See [Set the Network Address](#) in chapter 3 for details on setting the IP address.
14. Slide the safety end cap up to remove it, exposing the backplane and power interconnections.

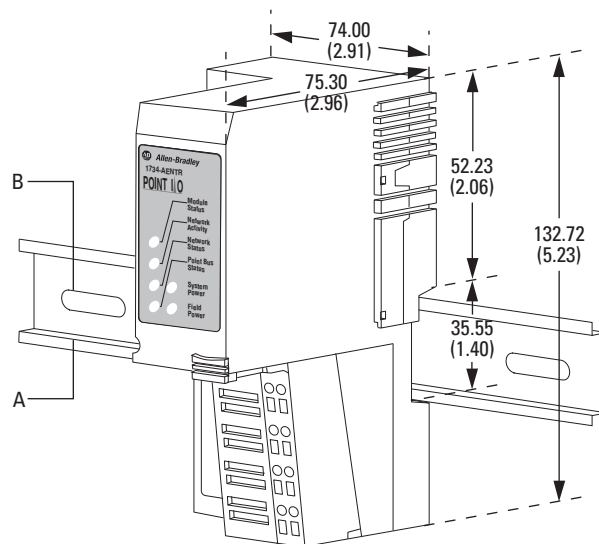

A = DIN rail

B = Secure DIN rail approximately every 200 mm (7.8 in.)

45174



ATTENTION: Do not discard the end cap. Use this end cap to cover the exposed interconnections on the last mounting base on the DIN rail. Failure to do so could result in equipment damage or injury from electric shock.



ATTENTION: This product is grounded through the DIN rail to chassis ground. Use zinc plated yellow-chromate steel DIN rail to assure proper grounding. The use of other DIN rail materials (for example, aluminum or plastic) that can corrode, oxidize, or are poor conductors, can result in improper or intermittent grounding. Secure DIN rail to mounting surface approximately every 200 mm (7.8 in.) and use end-anchors appropriately.

Install POINT I/O Modules

The following instructions explain how to install your POINT I/O Modules onto the DIN rail.

1. Position the mounting base vertically above the DIN rail.
2. Make certain the adapter DIN rail locking screw (orange) is in the horizontal position.
3. Slide the I/O module mounting base down, allowing the interlocking side pieces to engage the adjacent mounting base/adapter.
4. Press down firmly to install the I/O module mounting base on the DIN rail. A locking mechanism locks the mounting base to the DIN rail.
5. Rotate the keyswitch on the I/O module mounting base clockwise until the appropriate number for the module you are installing (listed on the module label) aligns with the correct notch in the base.
6. Position the I/O module vertically above its mounting base.
7. Slide the module down until it engages the latching mechanism. You will hear a clicking sound when the I/O module is properly engaged. The locking mechanism locks the module to its mounting base.

Remove POINT I/O Modules

To remove a module from its mounting base:

1. Put a flat-blade screwdriver into the slot of the orange latching mechanism in the mounting base of the I/O module to be removed.
2. Push the screwdriver toward the I/O module to disengage the latch. The module lifts up off the mounting base.
3. Pull the module off the mounting base.

Mount the ArmorPOINT I/O Adapter on a Panel or Wall

To mount the ArmorPOINT I/O adapter on a wall or panel, use the screw holes provided in the adapter module.



ATTENTION: This product is intended to be mounted to a well-grounded mounting surface such as a metal panel. Additional grounding connections from the power supply's mounting tabs or DIN rail (if used) are not required unless the mounting surface cannot be grounded. Refer to Industrial Automation Wiring and Grounding Guidelines, Rockwell Automation publication [1770-IN041](#), for additional information.

Refer to the drilling dimensions illustration for the ArmorPOINT I/O adapter with I/O bases to guide you in mounting the adapter and I/O module mounting bases.

Mounting illustration for the ArmorPOINT adapter and I/O Mounting bases

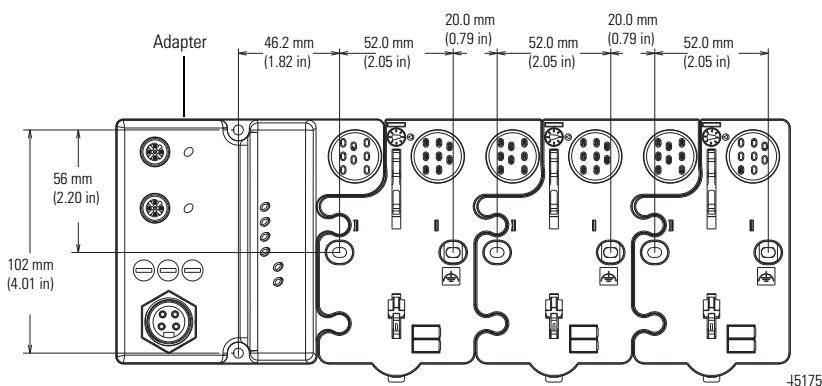

Install the adapter and its I/O mounting base as follows:

1. Lay out the required points as shown above in the drilling dimension drawing.
2. Drill the necessary holes for M4 (#8) machine or self-tapping screws.
3. Mount the adapter using M4 (#8) screws.
4. Ground the system using the ground lug connection in the adapter's I/O base. (The ground lug connection is also a mounting hole).
5. Add one or more I/O modules and their respective I/O Mounting bases to the adapter and its I/O Mounting base as required. See [Install ArmorPOINT I/O Modules](#) on [page 17](#) for details.

6. Mount the terminating base shipped with the adapter as the last base in the backplane instead of the I/O Mounting base shipped with the I/O module.

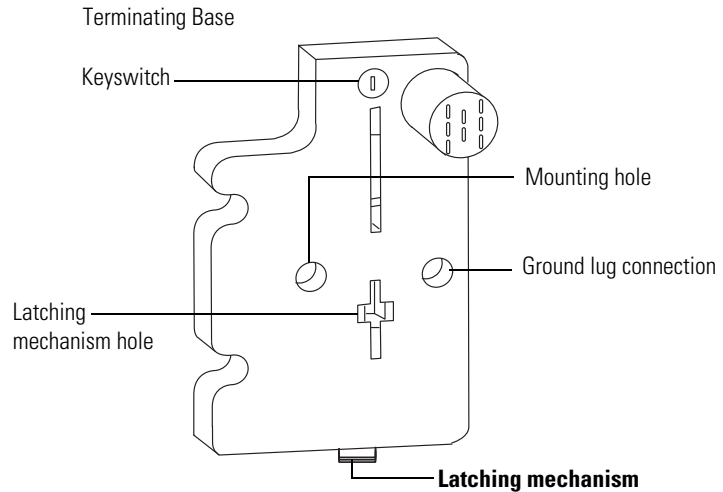

43787



ATTENTION: If this equipment is used in a manner not specified by the manufacturer, the protection provided by the equipment may be impaired.

Install ArmorPOINT I/O Modules

To install the ArmorPOINT I/O module onto an I/O module mounting base,

1. Using a bladed screwdriver, rotate the keyswitch on the I/O module mounting base clockwise until the appropriate number for the I/O module you are installing aligns with the notch in the I/O module mounting base.
2. Position the I/O module vertically above the I/O module mounting base. The module bridges two I/O module mounting bases.

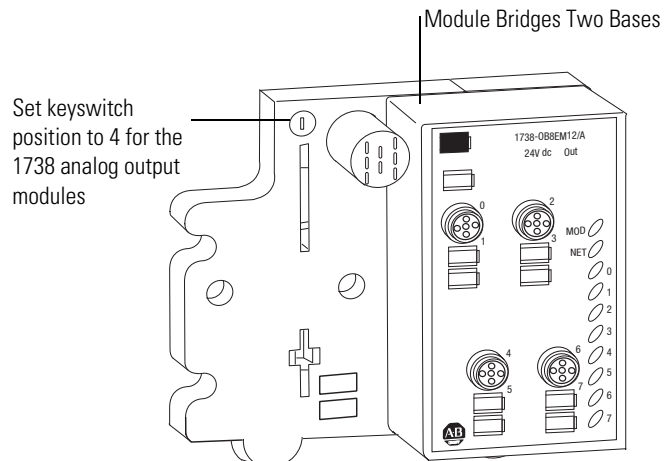

43771

3. Push the module down until it engages the latching mechanism. You hear a clicking sound when the module is properly engaged. The locking mechanism locks the I/O module to the I/O module mounting base.

Remove ArmorPOINT I/O Modules

To remove a module from its mounting base:

1. Put a flat-blade screwdriver into the slot of the orange latching mechanism.
2. Push the screwdriver toward the I/O module to disengage the latch. The module lifts up off the base.
3. Pull the module off the base.

Replace An Adapter

Use these procedures to install a replacement POINT I/O adapter to an existing system.



ATTENTION: Do not remove or replace an Adapter Module while power is applied. Interruption of the backplane can result in unintentional operation or machine motion.



WARNING: When you insert or remove the module while backplane power is on, an electrical arc can occur. This could cause an explosion in hazardous location installations.

Be sure that power is removed or the area is nonhazardous before proceeding. Repeated electrical arcing causes excessive wear to contacts on both the module and its mating connector. Worn contacts may create electrical resistance that can affect module operation.

1. Disconnect the Ethernet connector(s) from the adapter.
2. Pull up on the Removable Terminal Block (RTB) handle to remove the terminal block.
3. Remove the adjacent module from its mounting base.
4. Use a small bladed screwdriver to rotate the DIN rail locking screw (orange) to a vertical position. This releases the locking mechanism.
5. Lift the adapter straight up to remove.
6. Position the replacement adapter vertically above the DIN rail, making certain the DIN rail locking screw (orange) is in the horizontal position.
7. Slide the adapter down, allowing the interlocking side pieces to engage the adjacent module.
8. Press firmly to seat the adapter on the DIN rail, noting that the adapter locking mechanism will snap into place.
9. Set the network address on the network address thumbwheel.
10. Insert the end of the Removable Terminal Block opposite the handle into the Removable Terminal Block base unit, noting that this end has a curved section that engages with the base unit.
11. Rotate the Removable Terminal Block into the wiring base until it locks into place.
12. Replace the adjacent module in its mounting base.
13. Reconnect the Ethernet cable(s) to the adapter.
14. Set the IP Address for this module (see [Set the Network Address](#) in chapter 3).
15. Configure the adapter's chassis size.

Wire the Adapter

The POINT I/O adapter uses RJ45 EtherNet/IP connectors for its EtherNet/IP connections; the ArmorPOINT I/O adapter uses M12 Female in connectors for its EtherNet/IP connections and one 4-pin Mini-Style Male in connector for the Auxiliary Power connection. Connect the cord sets you selected for your module to the appropriate ports.

Wire a POINT I/O Adapter

Refer to the following illustration to wire the adapter.

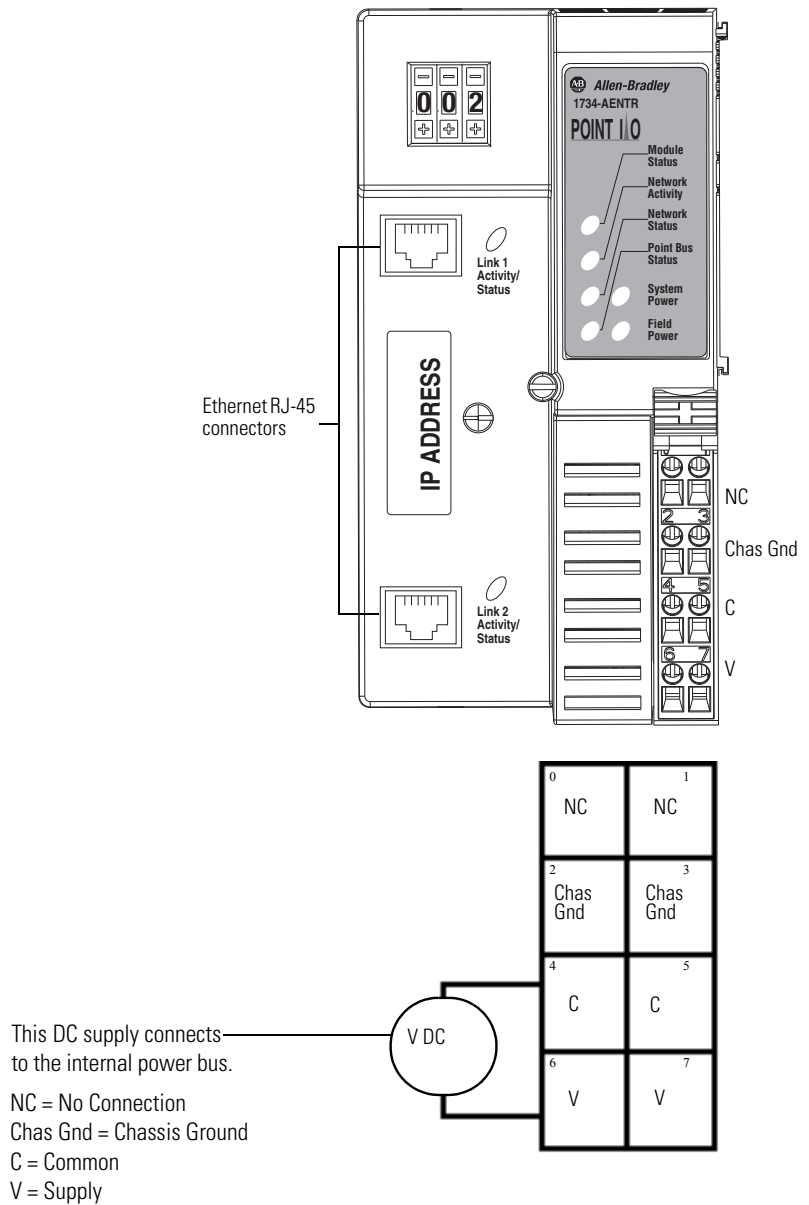

ATTENTION: Do not connect 120/240V AC power to this supply. This DC supply will be connected to the internal power bus.



ATTENTION: Do not wire more than two conductors on any single terminal.



WARNING: When you connect or disconnect the Removable Terminal Block (RTB) with field side power applied, an electrical arc can occur. This could cause an explosion in hazardous location installations.

Be sure that power is removed or the area is nonhazardous before proceeding.



WARNING: When used in a Class I, Division 2, hazardous location, this equipment must be mounted in a suitable enclosure with proper wiring method that complies with the governing electrical codes.



WARNING: If you connect or disconnect the communications cable with power applied to this module or any device on the network, an electrical arc can occur. This could cause an explosion in hazardous location installations.

Be sure that power is removed or the area is nonhazardous before proceeding.

Wire an ArmorPOINT I/O Adapter

Refer to the following illustration to wire the adapter

EtherNet/IP Connectors

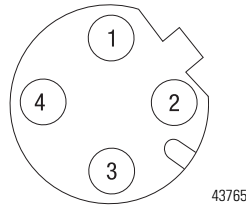

M12 Female in Connector

(view into connector)

Pin 1 - Tx +

Pin 2 - Rx +

Pin 3 - Tx -

Pin 4 - Rx -

Auxiliary Power Connector ⁽¹⁾

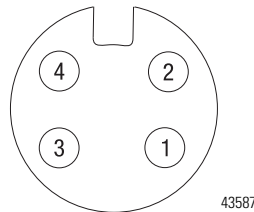

Mini Style 4-Pin in Male Connector

(view into connector)

Pin 1 - User Power +

Pin 2 - Adapter Power +

Pin 3 - Adapter Power -

Pin 4 - User Power -



ATTENTION: Make sure all connectors and caps are securely tightened to properly seal the connections against leaks and maintain IP enclosure type requirements.

IMPORTANT

Analog modules have earth grounded metal rings. This should be considered when choosing shielded cables and grounding techniques.

Chapter Summary

In this chapter, you learned how to install and wire your POINT I/O or ArmorPOINT adapter module. The following chapter describes how to configure your POINT I/O or ArmorPOINT I/O adapter module to communicate on the EtherNet/IP network by providing an IP address, gateway address, and Subnet mask.

(1) Auxiliary power cable: standard cordset (single-ended), for example Allen-Bradley part number 889N-F4AFC-6F or 889N-R4AFC-6F; or standard patchcord (double-ended), for example, Allen-Bradley part number 889N-F4AFNU-6F or 889N-F4AFNV-6F. Refer to publication [M117-CA001A-EN-P](#) for more information.

Configure the Adapter with RSLogix 5000 or Logix Designer Software

Introduction

This chapter guides you through the steps required to configure your modules using the RSLogix 5000 or Logix Designer⁽¹⁾ software. Note that the modules presented in this chapter can be configured using RSLogix 5000 software, version 17, or later.

Before using your adapter in an EtherNet/IP network, you need to configure it with an IP address, subnet mask, and optional Gateway address. This chapter describes these configuration requirements and the procedures for providing them. Here are ways you can do this:

- Use the Rockwell BootP/DHCP Server tool, version 2.3 or later, that ships with RSLogix 5000 or RSLinx software.
 - You can also use this utility to reconfigure a device with an IP address you must change.
- Use a third party DHCP server.
- Use the Network Address thumbwheel switches.
- Have your network administrator configure the adapter via the network DHCP server.

See the table for where to find information in this chapter.

Topic	Page
Configuration Requirements	24
IP Address	24
Gateway Address	25
Subnet Mask	26
Set the Network Address	27
Set the Network Address for POINT I/O Adapters	27
Set the Network Address for ArmorPOINT I/O Adapters	28
Use the Rockwell BootP/DHCP Server tool	29
Save the Relation List	32
Use DHCP Software to Configure Your Adapter	33
Chapter Summary	33

(1) From version 21 onwards, RSLogix 5000 is known as Logix Designer.

Configuration Requirements

Adding POINT and ArmorPOINT modules through RSLogix 5000 involves the same general procedures. Note, however, that the two modules do not have exactly similar Module Definition properties or configuration parameters. The customization of both modules are distinctly covered in the next sections.

Before you can use your adapter, you must configure its IP address, its subnet mask, and, optionally, a gateway address. You can use the Rockwell BootP/DHCP Server tool, version 2.3 or later, to perform the configuration. You can also use a DHCP server or the network address switches to configure these parameters.



ATTENTION: Check the Product Compatibility and Download Center (PCDC) to verify the compatibility between your POINT I/O module and the POINT I/O adapter.

If you need to reset the adapter to factory defaults, see [Work with the Configuration Pages on page 106](#).

IP Address

The IP address identifies each node on the IP network (or system of connected networks). Each TCP/IP node on a network (including the adapter) must have a unique IP address.

The IP address is 32 bits long and has a Network ID part and Host ID part. Networks are classified A, B, C, (or other). The class of the network determines how an IP address is formatted.

	0	7	8	31
Class A	Network ID		Host ID	
	0	15	16	31
Class B	Network ID		Host ID	
	0	23	24	31
Class C	Network ID		Host ID	
	110			

You can distinguish the class of the IP address from the first integer in its dotted-decimal IP address as follows:

Range of first integer	Class	Range of first integer	Class
0 1...127	A	192...223	C
128...191	B	224... 255	other

Each node on the same physical network must have an IP address of the same class and must have the same network ID. Each node on the same network must have a different Host ID thus giving it a unique IP address.

IP addresses are written as four decimal integers (0...255) separated by periods where each integer gives the value of one byte of the IP address.

EXAMPLE For example, the 32-bit IP address:
10000000 00000001 00000000 00000001 is written as
128.1.0.1

Gateway Address

This section applies to multi-network systems. If you have a single network system, refer to the next section.

The Gateway Address is the default address of a network. It provides a single domain name and point of entry to the site. Gateways connect individual physical networks into a system of networks.

When a node needs to communicate with a node on another network, a gateway transfers the data between the two networks. The figure shows gateway G connecting Network 1 with Network 2.

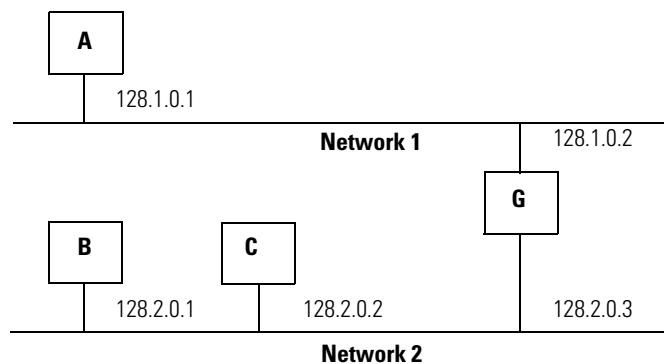

When host B with IP address 128.2.0.1 communicates with host C, it knows from C's IP address that C is on the same network. In an Ethernet environment, B can then resolve C's IP address into a hardware address (MAC address) and communicate with C directly.

When host B communicates with host A, it knows from A's IP address that A is on another network (the network IDs are different). In order to send data to A, B must use the IP address of the gateway connecting the two networks. In this example, the gateway's IP address on Network 2 is 128.2.0.3.

The gateway has two IP addresses (128.1.0.2 and 128.2.0.3). The first must be used by hosts on Network 1 and the second must be used by hosts on Network 2. To be usable, a gateway of a host must be addressed using a network ID matching its own.

Subnet Mask

The subnet mask is used for splitting IP networks into a series of subgroups, or subnets. The mask is a binary pattern that is matched up with the IP address to turn part of the Host ID address field into a field for subnets.

EXAMPLE Take Network 2 (a Class B network) in the previous example and add another physical network. Selecting the following subnet mask would add two additional network ID bits, allowing for four physical networks: $11111111\ 11111111\ \mathbf{11}000000\ 00000000 = 255.255.192.0$



 These two bits of the Host ID are used to extend the network ID.

Two bits of the Class B host ID are used to extend the network ID. Each unique combination of bits in the part of the Host ID where subnet mask bits are 1 specifies a different physical network.

The new configuration is:

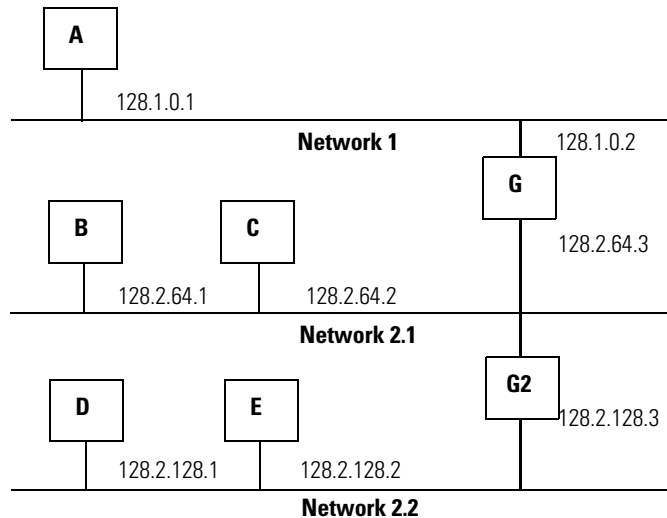

A second network with Hosts D and E was added. Gateway G2 connects Network 2.1 with Network 2.2.

Hosts D and E will use Gateway G2 to communicate with hosts not on Network 2.2.

Hosts B and C will use Gateway G to communicate with hosts not on Network 2.1.

When B is communicating with D, G (the configured Gateway for B) will route the data from B to D through G2.

Set the Network Address

The adapters ship DHCP-enabled and with the thumbwheels or switches set to 999. You can set the network Internet Protocol (IP) address as follows.

Set the Network Address for POINT I/O Adapters

- Use the pen-push thumbwheels located on the adapter. Press either the + or - button with a pen tip to change the number.
- Use a Dynamic Host Configuration Protocol (DHCP) server, such as Rockwell Automation BootP/DHCP Server.
- Retrieve the IP address from non-volatile memory.

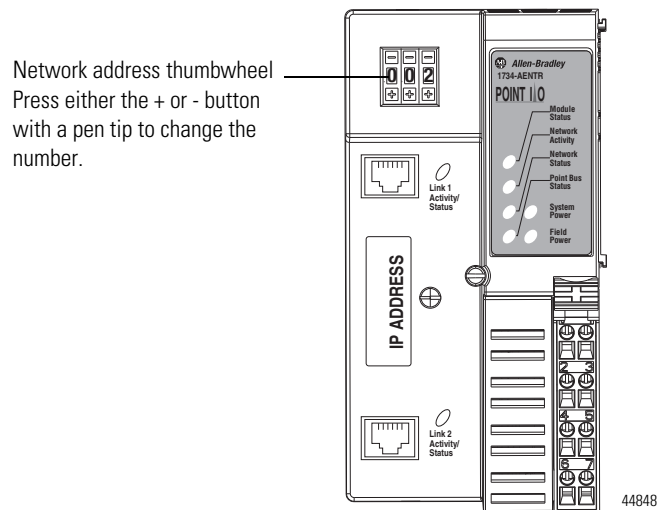

The adapter reads the thumbwheels first to determine if the thumbwheels are set to a valid number. You set the node address by using the 3-position pen-push thumbwheel using a pen tip.

Note: Press a pen tip into the center and perpendicular to the + or the - button to change the number. You only need a small amount of force to press the button (approximately 2N).

Valid settings range from **001...254**. When you use the thumbwheel to assign an address and set it to **001**, the adapter gateway address is set to **0.0.0.0** and the subnet mask is set to **255.255.255.0**. When you use the thumbwheel to assign an address and set it between **002...254**, the adapter gateway address is set to **192.168.1.1**.

The adapter does not have a host name assigned, or use any Domain Name System when using the thumbwheel settings.

If DHCP is not enabled, the adapter uses the IP address, along with other TCP configurable parameters, stored in non-volatile memory.

Set the Network Address for ArmorPOINT I/O Adapters

- Adjust the switches in front of the module
- Use a Dynamic Host Configuration Protocol (DHCP) server such as Rockwell Automation BootP/DHCP Server.
- Retrieve the IP address from non-volatile memory

The adapter reads the switches first to determine if the switches are set to a valid number. Set the network address by adjusting the three switches on the front of the adapter.

Figure 1 - Network Address Example

This example shows the network address set at 163.

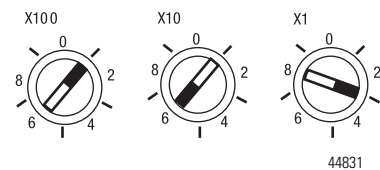

Use a small blade screwdriver to rotate the switches. Line up the small notch on the switch with the number setting you wish to use. Valid settings range from **001...254**.

When you use the switches to assign an address and set it to **001**, the adapter gateway address is set to **0.0.0.0**, and the subnet mask is **255.255.255.0**. When you use the switches to assign an address and set it to a valid number between **002...254**, the adapter gateway address is set to **192.168.1.1**.

If the switches are set to an invalid number (for example, 000 or a value greater than 254 excluding 888), the adapter checks to see if DHCP is enabled. If DHCP is enabled, the adapter requests an address from a DHCP server. The DHCP server also assigns other Transport Control Protocol (TCP) parameters.

If DHCP is not enabled, the adapter uses the IP address, along with other TCP configurable parameters, stored in non-volatile memory.



WARNING: When you change switch settings while power is on, an electrical arc can occur. This could cause an explosion in hazardous location installations.

Be sure that power is removed or the area is nonhazardous before proceeding.

Use the Rockwell BootP/DHCP Server tool

The 1734-AENTR/C adapter should be configured using only DHCP. The Rockwell BootP/DHCP Server is a standalone program with a user-friendly graphical interface. It is located in the **Utils** directory on the RSLogix 5000 software installation CD. The adapter must have DHCP enabled (factory default and the network address switches set to an invalid value) to use the utility.

To configure your adapter using the BootP/DHCP Server, perform the following steps:

1. Run the BootP/DHCP Server software.

In the Request History panel you see the hardware addresses of devices issuing requests.

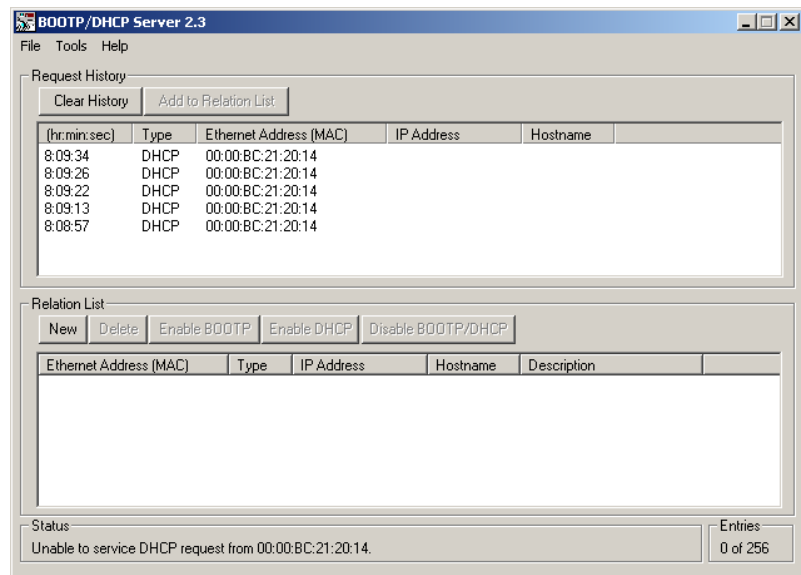

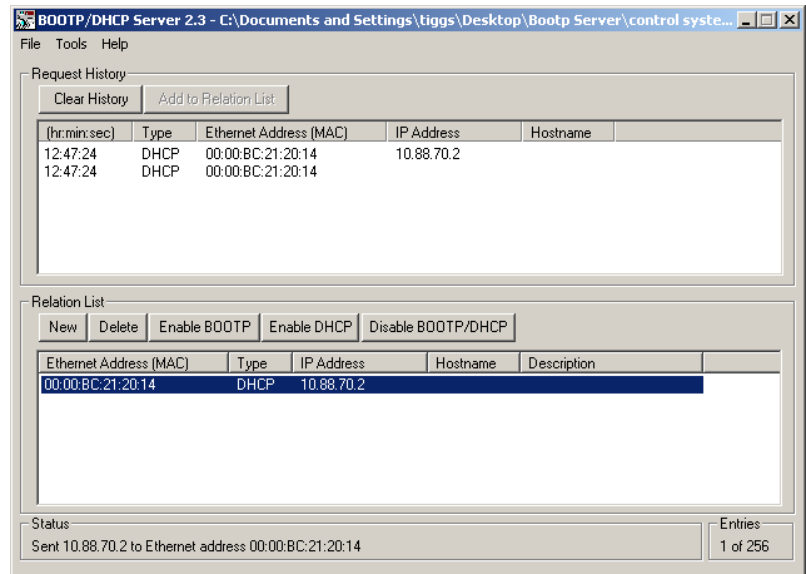

2. Double-click the hardware address of the device you want to configure.

The New Entry dialog appears with the device's Ethernet Address (MAC).

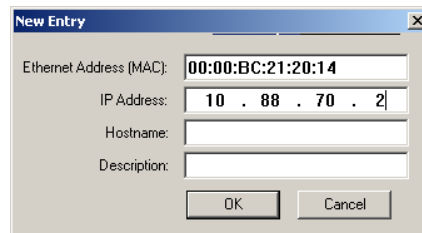

3. Enter the IP Address you want to assign to the device and click OK. The device is added to the Relation List, displaying the Ethernet Address (MAC) and corresponding IP Address, Hostname, and Description (if applicable).

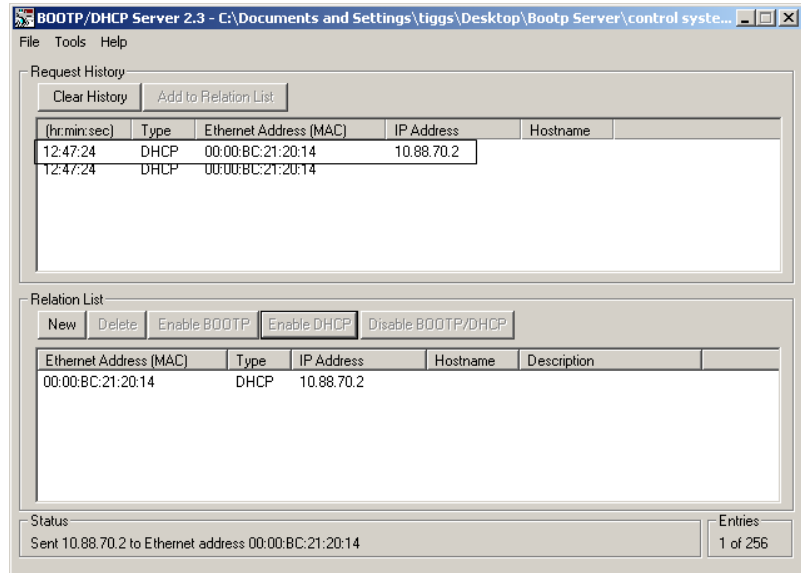

When the address displays in the IP Address column in the Request History section, the IP address assignment has been made.

4. To make this configuration static in the device, highlight the device in the Relation List panel, and click the Disable BOOTP/DHCP button.

When power is cycled to the device, it uses the configuration saved in non-volatile memory and will not issue a DHCP request.

5. To enable DHCP for a device with DHCP disabled, highlight the device in the Relation List, and click the Enable DHCP button.

You must have an entry for the device in the Relation List panel to re-enable DHCP.

Save the Relation List

You can save the Relation List for later use. To save the Relation List, perform the following steps:

1. Select Save As... from the File menu.

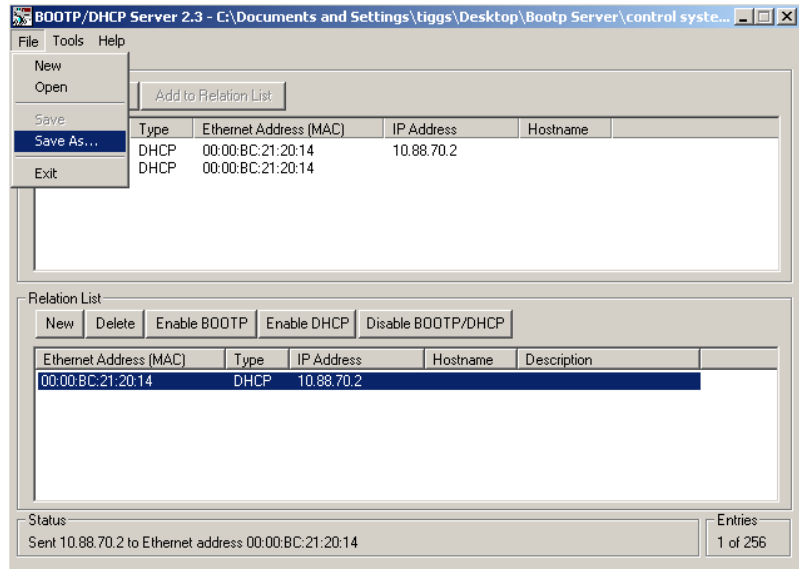

The Save As dialog appears.

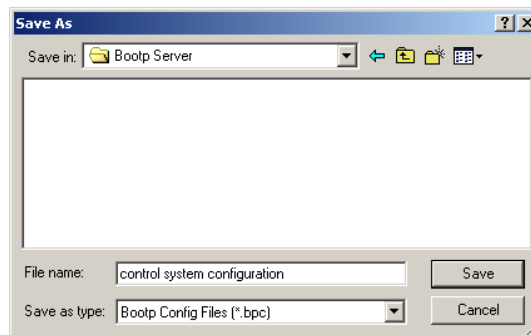

2. Select the folder where you want to save the Relation List.
3. Enter a File name for the Relation List, for example, control system configuration, and click Save.

You can leave the Save as type at the default setting: Bootp Config Files (*.bpc).

You now have the option to open the file containing the Relation List at a later session.

Use DHCP Software to Configure Your Adapter

DHCP (Dynamic Host Configuration Protocol) software automatically assigns IP addresses to client stations logging onto a TCP/IP network.

DHCP is based on BootP and maintains some backward compatibility. The main difference is that BootP was designed for manual configuration, while DHCP allows for dynamic allocation of network addresses and configurations to newly attached devices.

Be cautious about using DHCP software to configure your adapter. A DHCP server typically assigns a finite lease time to the offered IP address.

When 50% of the leased time has expired, the adapter attempts to renew its IP address with the DHCP server.

The possibility exists that the adapter will be assigned a different IP address, which would cause the adapter to cease communicating with the ControlLogix controller.

See [Configure the Adapter with Fixed IP Address](#) in [Chapter 4](#) to configure the adapter with a fixed IP address.



ATTENTION: To avoid unintended control or loss of control, the I/O adapter must be assigned a fixed IP address. A dynamically provided IP address should be used only at initial configuration. If a DHCP server is used, it must be configured to assign the same IP address to your adapter. Failure to observe this precaution may result in unintended machine motion or loss of process control.

Chapter Summary

This chapter provided instructions on how to configure POINT I/O and ArmorPOINT I/O Adapter modules through the RSLogix 5000 software and included information on configuration requirements and setting the network address.

Notes:

Configure the Adapter for Direct Connection in RSLogix 5000 or Logix Designer Software

Overview

This chapter guides you through the steps required to configure your modules using the RSLogix 5000 or Logix Designer⁽¹⁾ software.

In this example, a ControlLogix controller communicates with I/O modules via the adapter using a direct connection.

The adapter makes a direct connection to each of the modules referenced by the data. The modules presented in this chapter use RSLogix 5000 software, version 17, or later.

Topic	Page
Set Up the Hardware	36
Create the Example Application	37
Configure the I/O Modules	38
Add the Local EtherNet/IP Bridge to the I/O Configuration	39
Add the POINT I/O Adapter to the I/O Configuration	42
Add the POINT I/O Modules to the I/O Configuration	45
Edit the Controller Tags	51
Create the Ladder Program	52
Download the Program to the Controller	52
Verify the Module Chassis Size	53
Configure the Adapter with Fixed IP Address	56
Recover From an Overloaded Adapter	57
Chapter Summary	57



ATTENTION: Check the Product Compatibility and Download Center (PCDC) to verify the compatibility between your POINT I/O module and the POINT I/O adapter.

(1) From version 21 onwards, RSLogix 5000 is known as Logix Designer.

Set Up the Hardware

The following section describes how to set up the I/O Hardware.

In this example, a ControlLogix chassis contains the L63 controller in slot 1 and a 1756-ENBT bridge module in slot 3. The 1734-AENTR/C adapter is mounted on a DIN rail in slot 0, with a 1734-OW2/C relay output module in slot 1, a 1734-OV4E/C sink output module in slot 2, and a power supply (not shown).

To work along with this example, set up your system as shown in the figure.

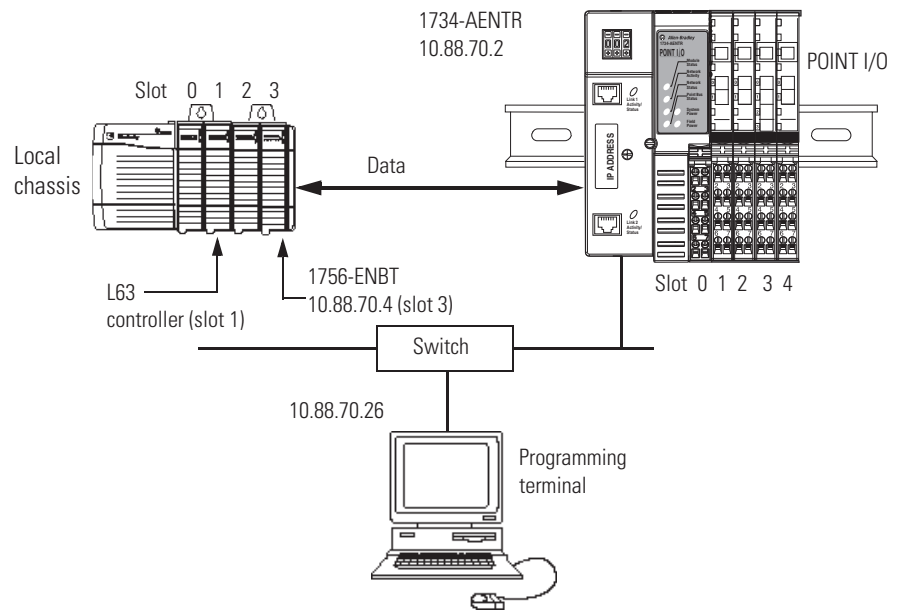

45176

- In the example application, we assume that the L63 controller and 1756-ENBT module (firmware revision 4.006, or later) are in the slots shown in the figure.
- Verify the IP addresses for your programming terminal, 1756-ENBT module, and adapter.
- Verify the position (slot) of the I/O modules on the DIN rail.
- Verify that you connected all wiring and cabling properly.
- Be sure you configured your communication driver (for example, AB_ETH-1 or AB-ETHIP-1) in RSLinx software, as described in Appendix C in this manual.

Create the Example Application

Perform the following steps to create the example application:

1. Start RSLogix 5000 Enterprise Series software to open the RSLogix 5000 main dialog.
2. From the File menu, select New.

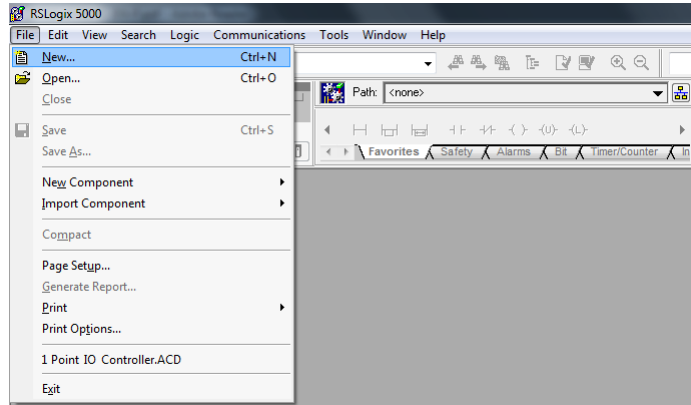

3. The New Controller dialog opens.

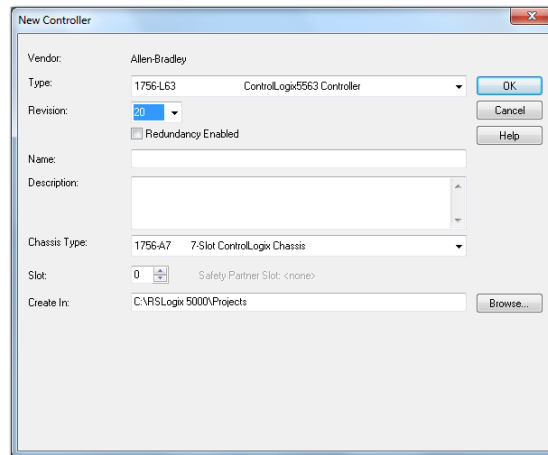

4. Enter an appropriate Name for the Controller, for example, POINT_IO_Controller.

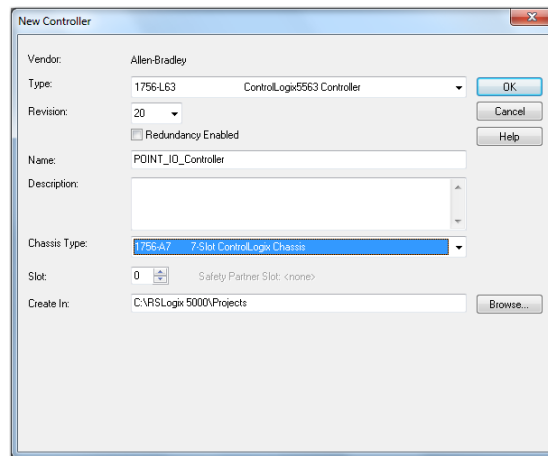

5. Select the correct Revision, Chassis Type, and Slot number of the L63 controller, and the folder where you want to save the RSLogix 5000 file (Create In). The Description is optional.

Note: RSLogix 5000 software Revision 18, and later, lets you enable redundancy. To use redundancy in your system, check the Redundancy Enabled checkbox in the Redundancy tab when using the said Revision or later.

6. Click OK.

Configure the I/O Modules

You now add the POINT I/O modules to the controller's I/O configuration performing these procedures:

- Add the local 1756-ENBT Bridge module to the I/O configuration.
- Add the 1734-AENTR/C adapter as a child of the 1756-ENBT module on the Ethernet network.
- Add the POINT I/O modules as children of the 1734-AENTR/C adapter.

IMPORTANT

Click the Help button on the configuration dialogs shown in this section if you need assistance in selecting and setting the parameters.

Add the Local EtherNet/IP Bridge to the I/O Configuration

1. Right-click the I/O Configuration folder in the project dialog, and select New Module.

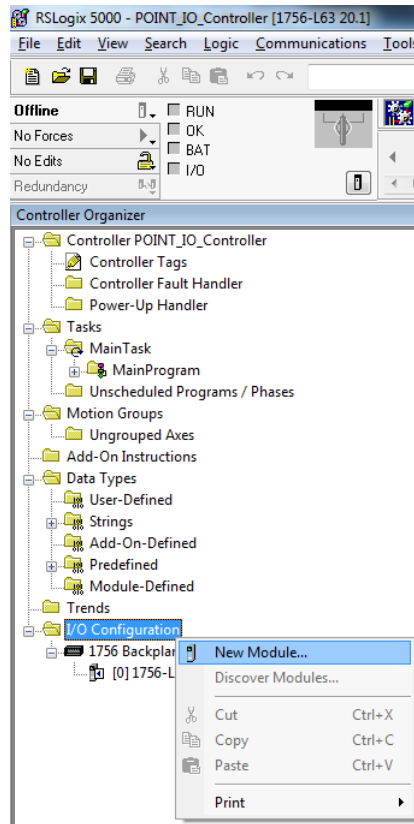

The Select Module Type dialog opens.

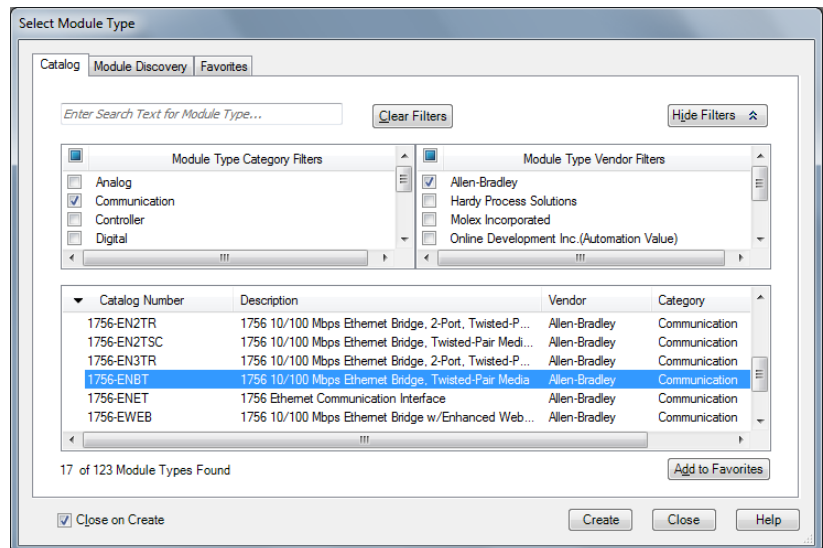

2. Select the appropriate Module Type filter Category (for the example we selected Communication), and Module Type Vendor (for the example we selected Allen-Bradley).

TIP In the Select Module Type dialog, you have options to search for a specific module, add modules to a Favorites list, filter by Category and/or Vendor, Hide and Show Filters, use Module Discovery, sort by vendor, or access your Favorites list.

Note: to select only one category you will need to unselect those already selected.

3. From the list of adapters displayed, select the 1756-ENBT EtherNet/IP Bridge and click Create.
4. The New Module dialog opens.

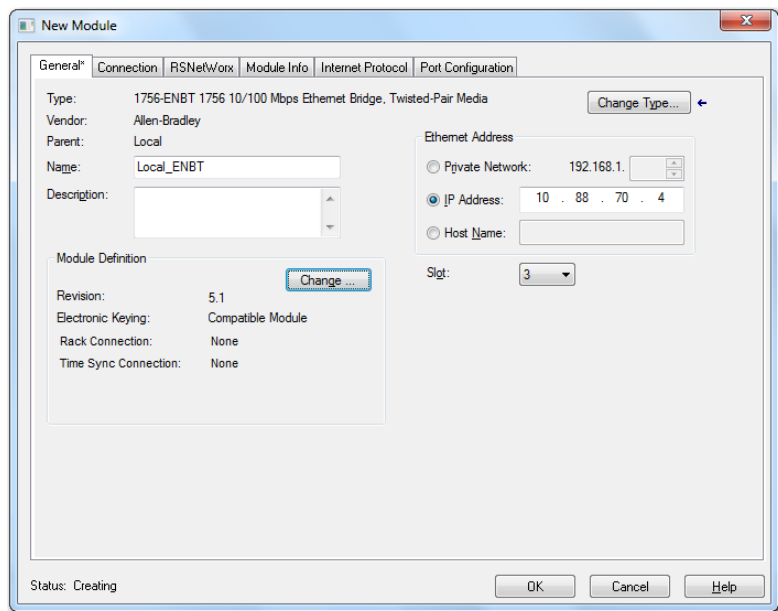

5. Enter values for Name, IP Address, and Slot, noting that we used the following values:

Name	Local_ENBT
IP Address	10.88.70.4
Slot	3

Note the module definition properties on the bottom left of the New Module dialog. You have the option to change these properties by clicking the Change button. Some of the properties cannot be modified while pending edits exists.

To change the default module properties,

6. Click Change...
The Module Definition dialog opens.

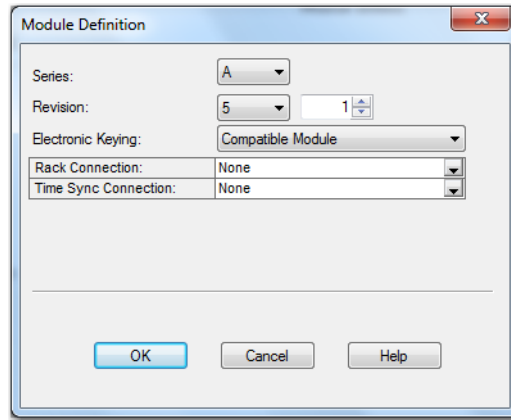

7. Enter or select values for Revision, Electronic Keying, Rack Connection, and Time Sync Connection, noting that we used the following values:

Series	A
Revision	5.1
Electronic Keying	Compatible Module
Rack Connection	None
Time Sync Connection	None

8. Click OK to accept the configuration.

The module appears indented under the I/O Configuration folder.

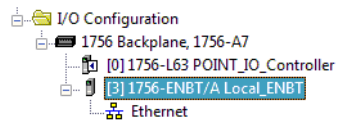

Add the POINT I/O Adapter to the I/O Configuration

Next, you must add the adapter as a child of the local 1756-ENBT module.

1. In the Project dialog, right-click the local 1756-ENBT module under the I/O Configuration folder, and select New Module from the dialog.

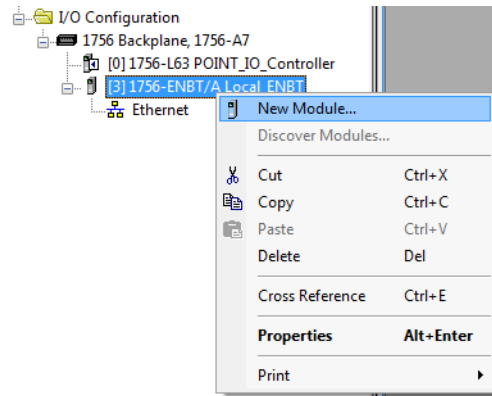

The Select Module Type dialog opens.

2. Select the appropriate Module Type filter Category (for the example we selected Communication), and Module Type Vendor (for the example we selected Allen-Bradley).

Note: to select only one category you will need to unselect those already selected.

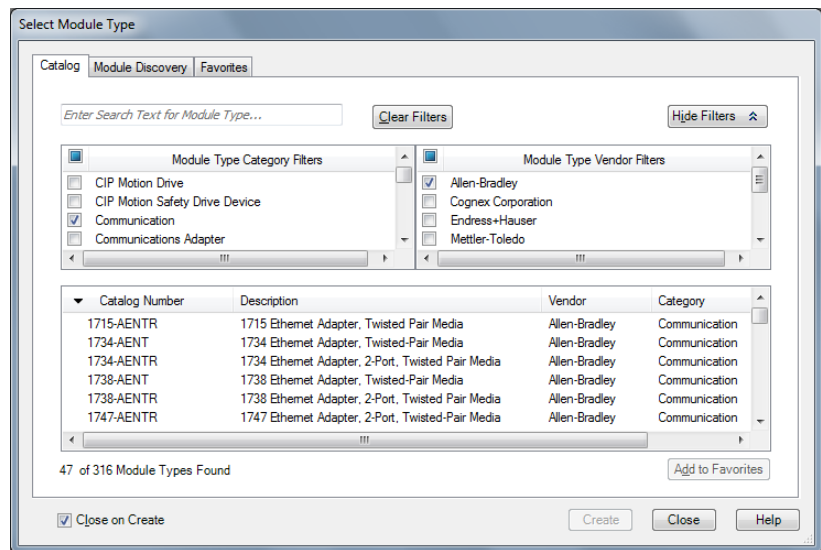

TIP

In the Select Module Type dialog, you have options to search for a specific module, add modules to a Favorites list, filter by Category and/or Vendor, Hide and Show Filters, use Module Discovery, sort by vendor, or access your Favorites list.

3. Select your adapter from the list (in our example we use 1734-AENTR/C) and click Create.
The New Module dialog opens.

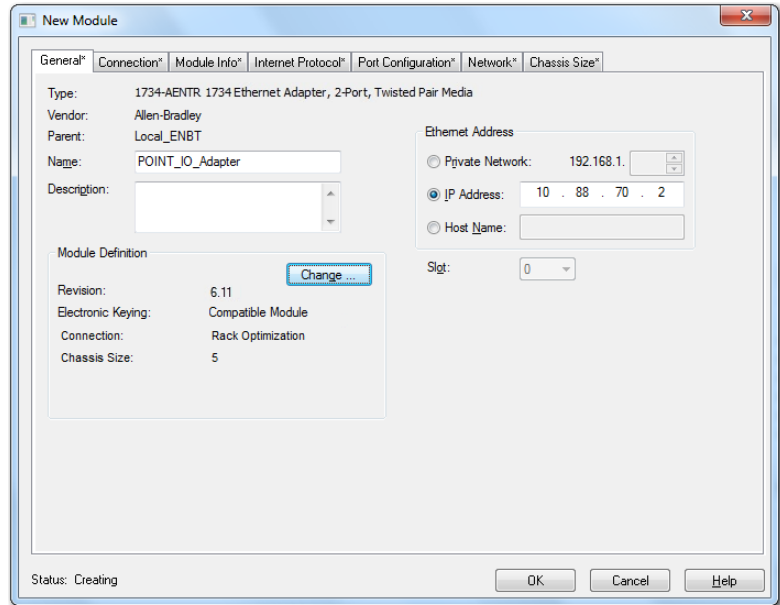

4. Select the General Tab and enter the module details, noting that we used the following values.

Name	POINT_IO_Adapter
IP Address	10.88.70.2

IMPORTANT Note that the slot field is disabled because the slot is automatically 0 for the 1734-AENTR/C adapter.

5. Click Change...
The Module Definition dialog opens.

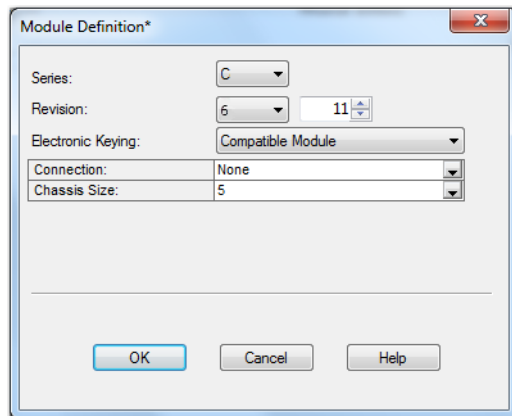

- Choose values for Series, Revision, Electronic Keying, Connection, and Chassis Size, noting that we used the following values:

Series	C
Connection	None
Chassis Size	5
Electronic Keying	Compatible Module
Revision	6.11

IMPORTANT The chassis size value equals 1 for the adapter plus the number of I/O modules installed (physically present on the I/O backplane).

Connection choices are the following:

- None – the adapter only makes a direct connection to each of the modules referenced by the data. RPI is disabled in this case.
 - Rack optimization – digital I/O data is collected into a rack image. This rack image does not include analog or specialty I/O modules.
 - Enhanced rack optimization – digital, analog, and specialty I/O data is collected into a rack image.
 - Listen only - rack optimization – read or verify input data only, but does not control the modules. When you have multiple controllers, one controller is used to control and the other controllers are used to monitor. When the owning controller of rack-optimization connection closes the connection, the Listen-Only data will also stop.
- Choose None as Connection, because we are only making direct connections, then click OK.

Note: There is no need to have a rack-optimization connection if all I/O connections to the POINT I/O modules are directly connected.

A dialog box opens.

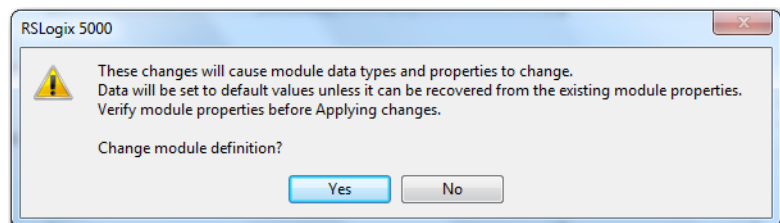

- Click Yes.

- In the New Module screen click OK to accept the new configuration. The 1734-AENTR/C adapter appears indented under the local 1756-ENBT bridge module in the I/O Configuration folder.

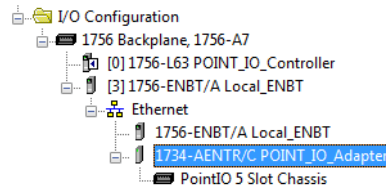

Note: The requested packet interval (RPI) is disabled (choose the Connection tab to review) because you have chosen None as the Connection.

Add the POINT I/O Modules to the I/O Configuration

You now add POINT I/O modules to the I/O Configuration List under the adapter.

In this example, you add a 1734-OW2 relay output module and a 1734-OV4E sink output module with standard configurations. Use these steps as a guide when configuring different I/O modules for your system.

TIP

This example application uses I/O module default configurations. For more information, refer to the POINT I/O Selection Guide, publication [1734-SG001](#).

Add the Digital Relay Output Module

- Right-click the adapter in the I/O Configuration folder and select New Module.

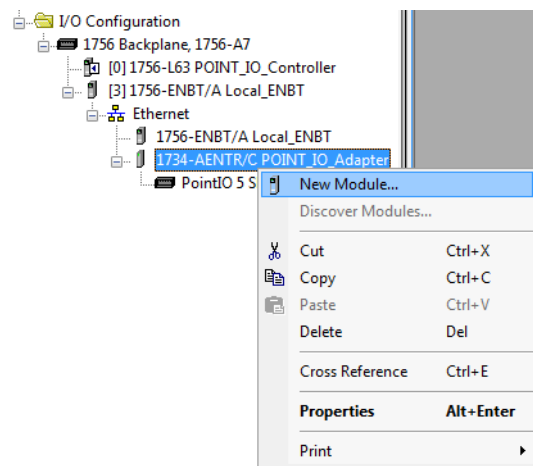

The Select Module Type dialog opens.

2. Select the appropriate filter for Module Type Category (for the example we selected Digital) and Module Type Vendor (for the example we selected Allen-Bradley).
Note: to select only one category you will need to unselect those already selected.
3. From the modules listed select the 1734-OW2 digital relay output module and click Create.

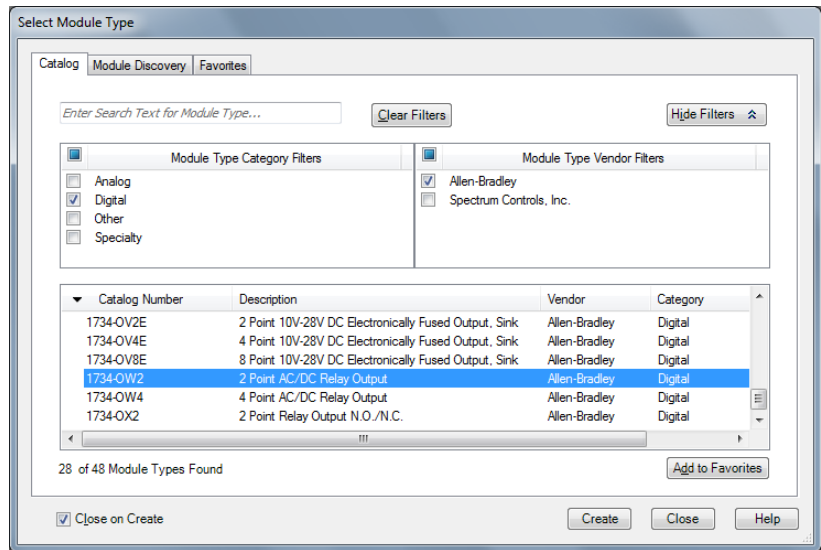

The New Module dialog opens.

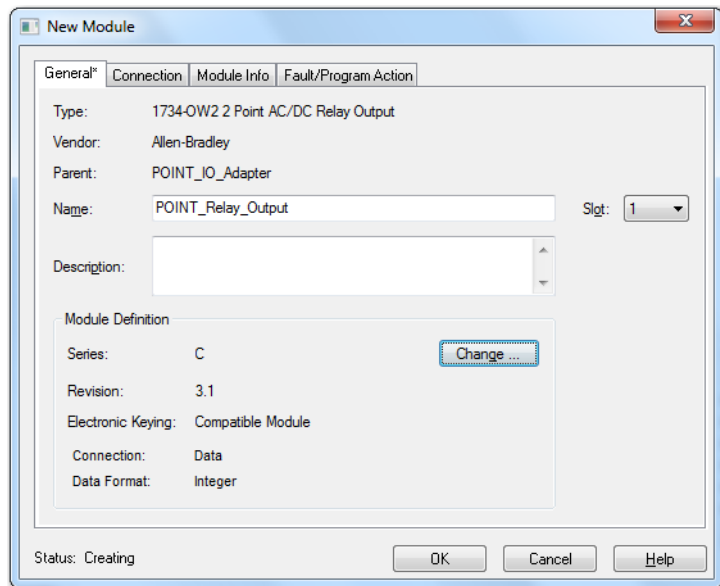

4. Enter values for Name and Slot, noting that we used the following values.

Name	POINT_Relay_Output
Slot	1

- Choose the Connection tab to set the RPI value.
RPI is selectable since it is a direct connection.

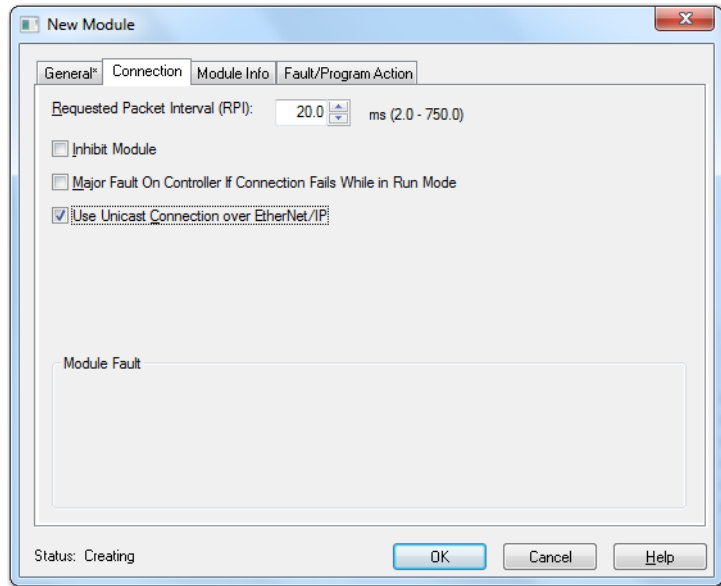

Note that the RPI is selectable on the screen and has a default value. Because we are making a direct connection to each I/O module, we must specify an RPI to determine how often the data is exchanged with the 1734-AENTR adapter for each module.

- Enter 50 for requested packet interval (RPI) to set how often you exchange data with the I/O adapters.

IMPORTANT To avoid overloading the I/O adapters, we recommend that RPI be no less than 10 ms for rack-optimization and enhanced rack-optimization connections, and 50 ms for direct connections.

- Click OK to save the configuration.
The relay output module appears under Ethernet.

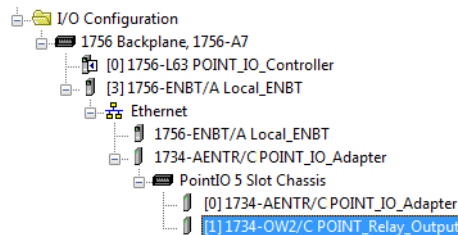

Add the Digital Output Module

1. In the Project dialog, right-click the 1734-AENTR/C adapter under the I/O Configuration folder and select New Module.

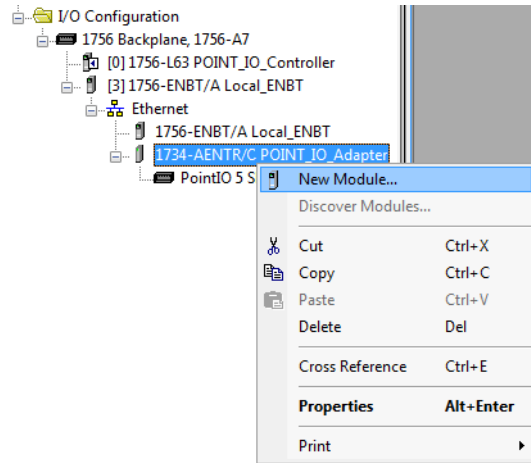

The Select Module Type dialog opens.

2. Select the appropriate Module Type Category Filter (for the example we selected Digital) and Module Type Vendor (for the example, we selected Allen-Bradley).

Note: to select only one category you will need to unselect those already selected.

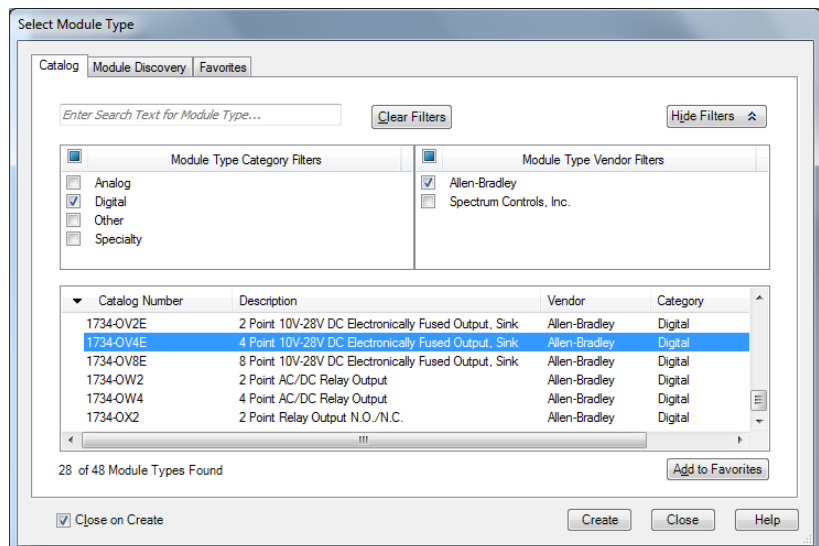

3. From the modules listed select the 1734-OV4E sink output module and click Create.

The New Module dialog opens.

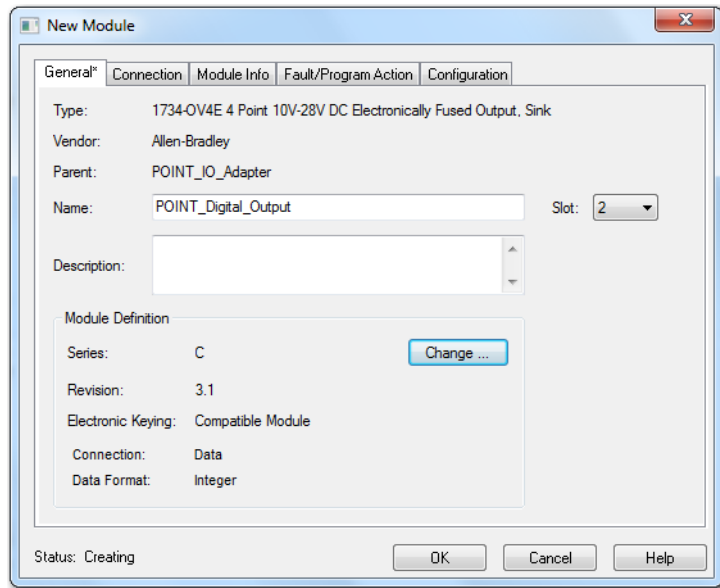

4. Enter values for Name and Slot, noting that we used the following values.

Name	POINT_Digital_Output
Slot	2

5. Choose the Connection tab to set the RPI value.
The RPI is selectable since it is a direct connection.

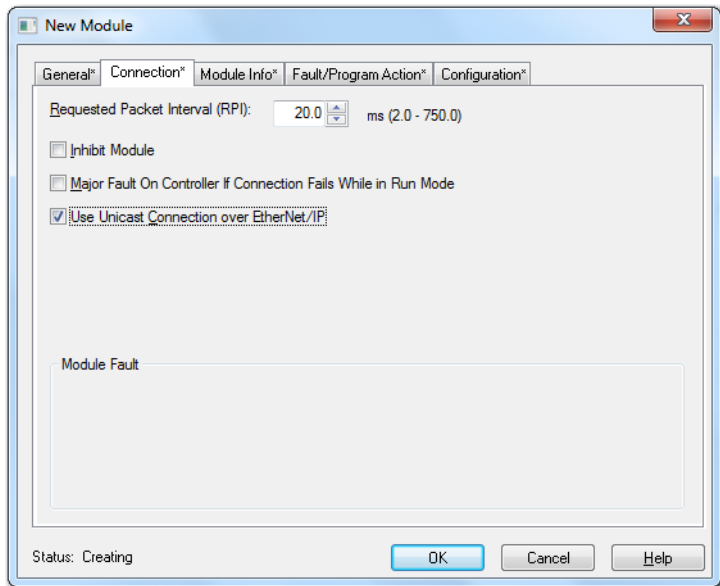

Note that the RPI is selectable and has a default value. Because we are making a direct connection to each I/O module, we must specify an RPI to determine how often the data is exchanged with the adapter for each module.

6. Enter 10 ms as the RPI for the 1734-OV4E module.

IMPORTANT To avoid overloading the I/O adapters, we recommend that RPI be no less than 10 ms for rack-optimization and enhanced rack-optimization connections, and 50 ms for direct connections.

7. Click OK to save the configuration.
The module appears in the I/O configuration folder indented under Ethernet.

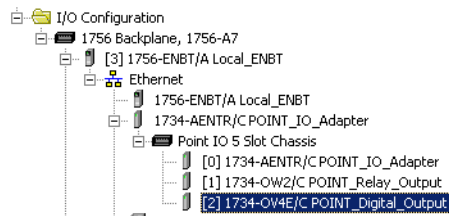

Edit the Controller Tags

When you add modules to the I/O configuration the system creates tags for those modules to use in the application program.

For the example application you need to add one more controller tag.

1. Double-click the Controller Tags folder in the project dialog.

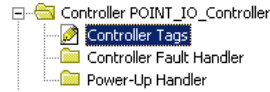

The Controller Tags dialog opens. You see the tags created for the 1734-AENTR adapter and its digital I/O modules.

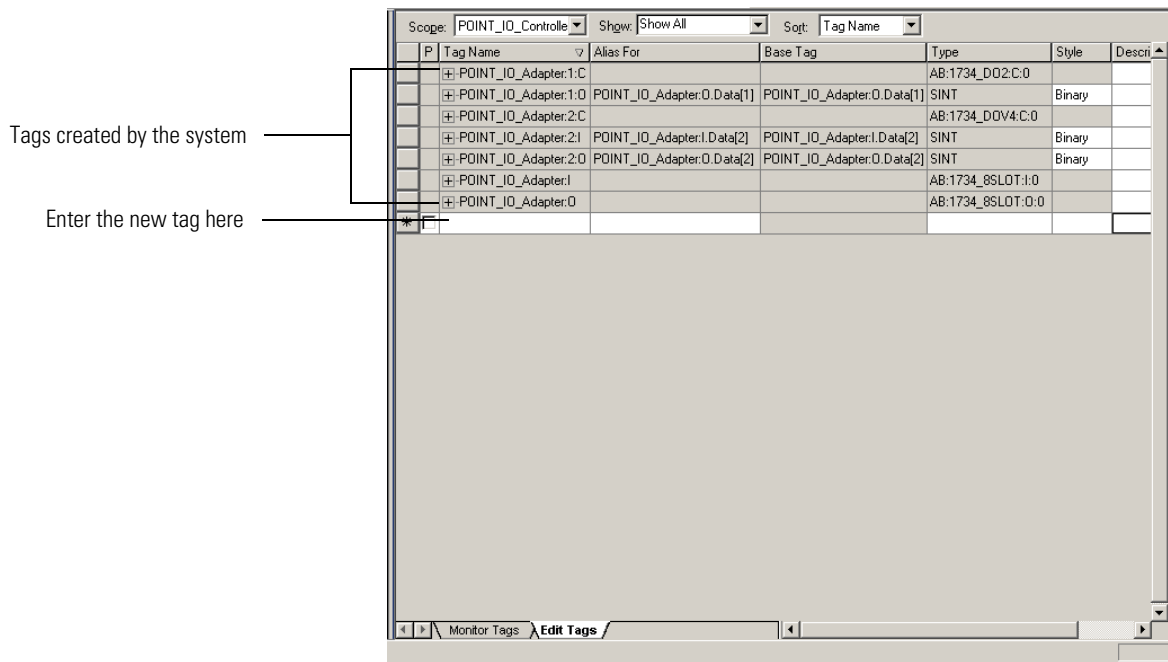

2. Click the Edit Tags tab at the bottom of the Controller Tags dialog.

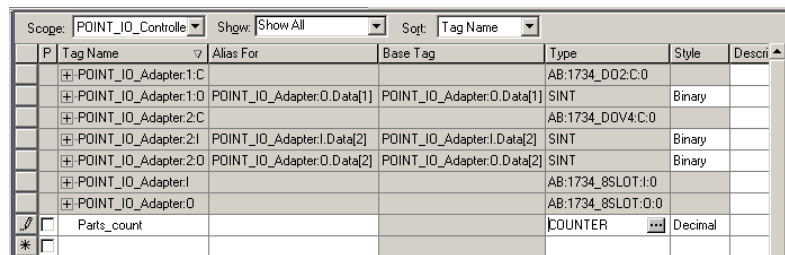

3. Create the following tag:

Tag	Type
Parts_Count	Counter

4. Close the Controller Tags dialog.

Create the Ladder Program

Create the example ladder program to test the I/O.

1. Under the Main Program folder, double-click Main Routine.

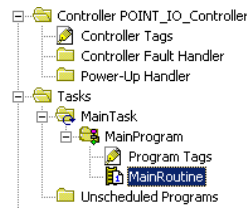

2. Enter the following ladder program using the tags previously created.

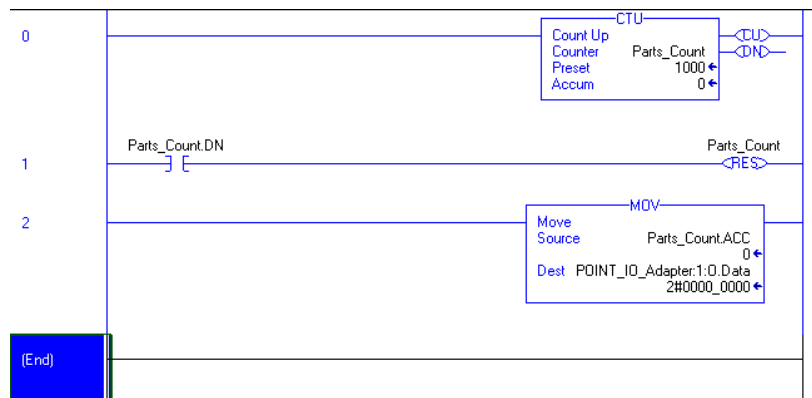

3. Save the program.

Download the Program to the Controller

Follow this procedure to download the program you just saved to the ControlLogix controller.

1. From the main menu, choose Communications>Who-Active. The Who Active dialog opens.

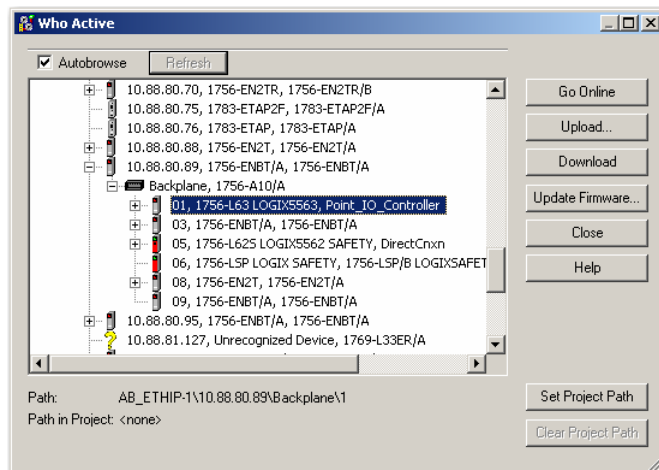

2. Navigate to select the slot where the controller is located in the chassis.
3. Choose Set Project Path.

4. Choose Download.

The Download dialog opens with a reminder of the following.

- The controller is in Remote Run mode.
- The mode changes to Remote Program prior to download.

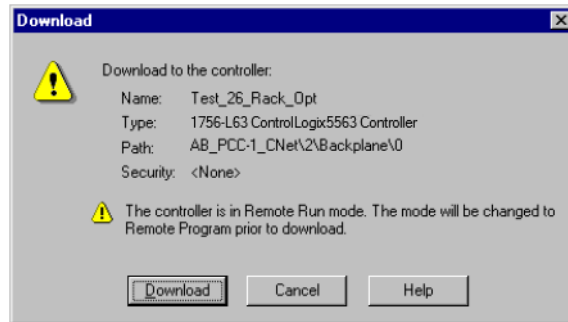

5. From the Download dialog, choose Download

The RSLogix 5000 software dialog opens.

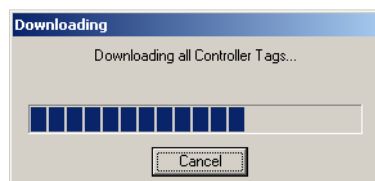

6. Notice that the 1756-ENBT Bridge is now online.

If yellow triangles are present, see the following section.

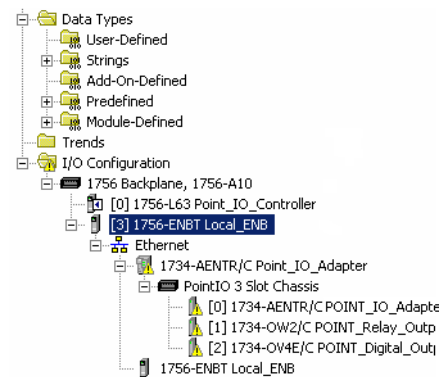

Verify the Module Chassis Size

You have now built the I/O tree in the RSLogix 5000 software, and the RSLogix 5000 software used the chassis size from the 1734-AENTR General tab.

Now you need to download this new chassis size value into the 1734-AENTR adapter hardware. This procedure synchronizes the chassis size value from the RSLogix 5000 software into the 1734-AENTR adapter hardware.

1. Verify that the RSLogix 5000 software is online.

2. In the Project dialog, right-click the 1734-AENTR adapter under I/O Configuration.
3. Select Properties.
4. Click the Connection tab.
The Module Fault error code displays.

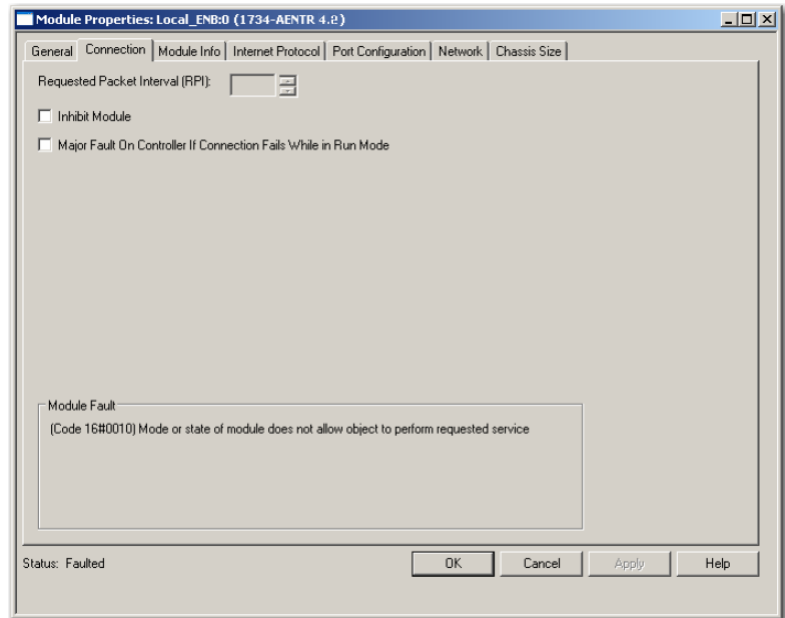

5. Click the Chassis Size tab.
6. Click Set Chassis Size in Module.

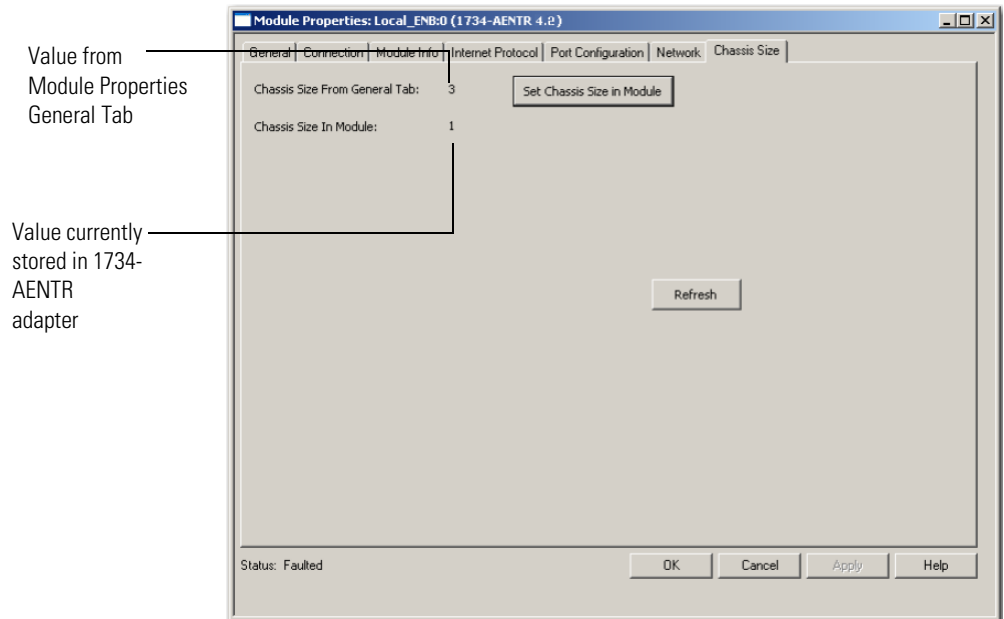

7. Read and acknowledge the warning dialog.

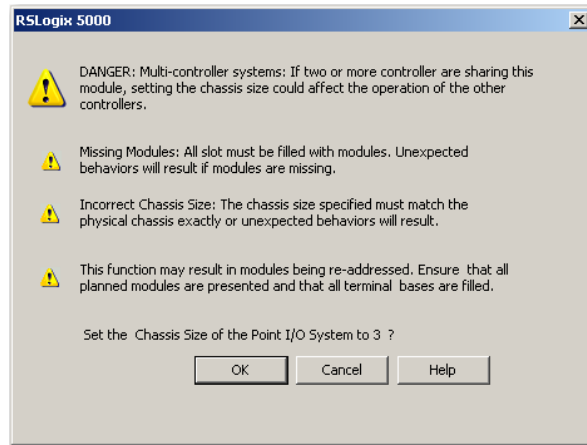

8. Click OK to continue.

Notice the chassis size stored in the module has been changed to 3.

At this point, your POINTBus status LED should be solid green. All the yellow triangles in your I/O configuration should be gone.

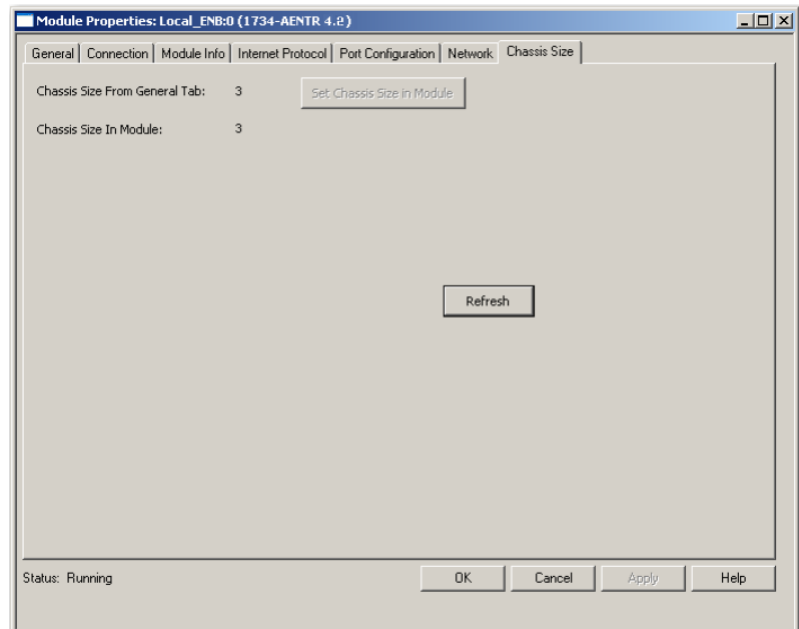

9. Click OK.

Configure the Adapter with Fixed IP Address

To configure the adapter with a fixed IP address to prevent the adapter from ceasing to communicate with the ControlLogix controller:

1. All controllers with I/O connections to the AENTR and/or the modules in its backplane need to be in program mode.
2. In the Module Properties dialog, click the Internet Protocol tab.

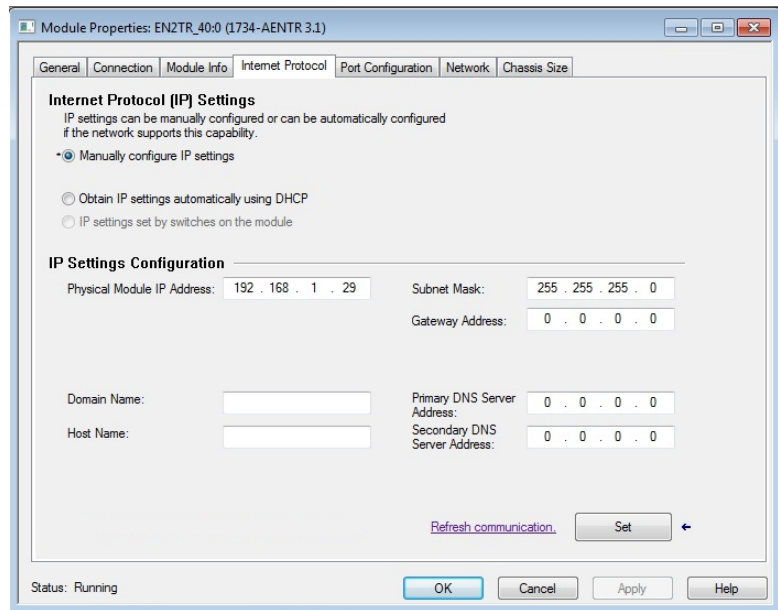

3. If it is not selected, select Manually configure IP settings.
4. Enter values for Physical Module IP Address, and Subnet Mask, noting we used the following values:

Physical Module IP Address	192.168.1.29
Subnet Mask	255.255.255.0

5. Click Set
6. Read and acknowledge the warning.

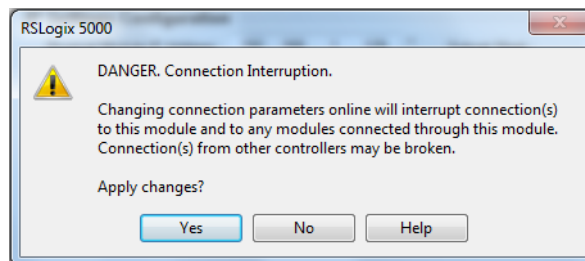

7. Click Yes.
8. Click the Refresh communication button to verify the changes.

Recover From an Overloaded Adapter

Each I/O connection established with the I/O adapter consumes a portion of microprocessor bandwidth. The amount of bandwidth used by a connection depends on several variables, such as the requested packet interval (RPI), number of I/O modules involved in the connection, and rate of change of the I/O.

The AENTR adapter continuously monitors this bandwidth and rejects requests for new I/O connections when there is insufficient bandwidth available to support the new connection.

The condition where the I/O adapters cannot support the connection due to a limit of the bandwidth of the microprocessor is shown on the Connection tab of the Module Properties dialog.

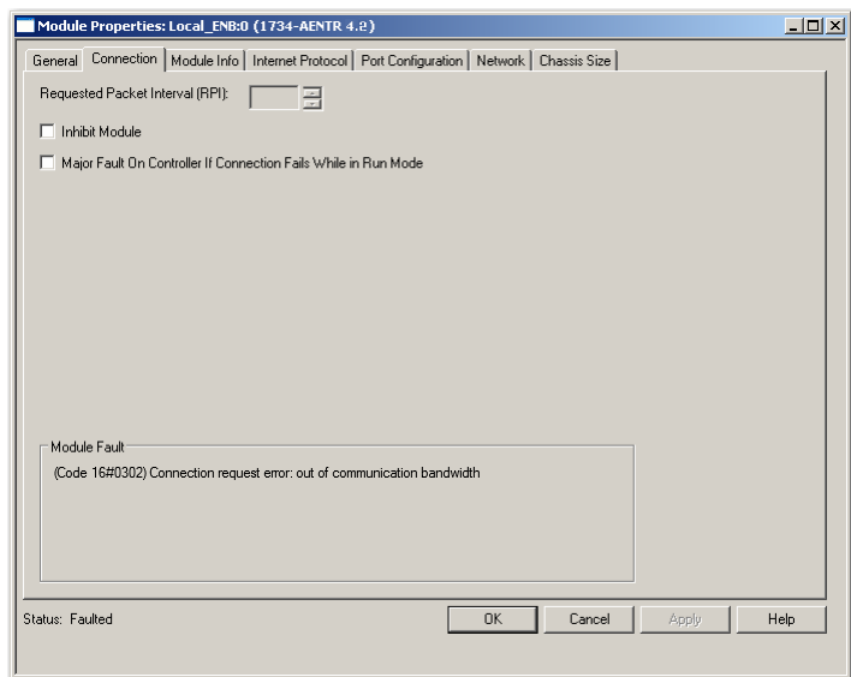

If you encounter this condition, the only action you can take is to alter the existing connections to reduce the amount of microprocessor bandwidth consumed. The most likely fixes for this condition include the following:

- Increase the RPI.
- Decrease the number of connections.
- Remove modules from the rack-optimization I/O connection.
- Remove the rack-optimization connection if there are no modules participating in it.

Chapter Summary

This chapter provided instructions on how to configure the POINT I/O Adapter for Direct Connection through the RSLogix 5000 software. It included information about setting up the hardware and configuring the I/O, adding the adapter to the configuration, and configuring the adapter with a fixed IP address.

Notes:

Configure the Adapter for Direct Connection, Rack Optimization, and Enhanced Rack Optimization in RSLogix 5000 or Logix Designer Software

Overview

This chapter guides you through the steps required to configure your AENTR adapter with direct, rack-optimization, and enhanced rack-optimization I/O connections using RSLogix 5000 or Logix Designer⁽¹⁾ software.

You can mix I/O connection formats for different I/O modules communicating through the same adapter. I/O modules set up to use rack optimization or enhanced rack-optimization communicate at the rate of the RPI configured for the adapter.

I/O modules controlled by a direct I/O connection communicate at their own set RPI. The RPI of the rack-optimization or enhanced rack-optimization I/O connection has no bearing on the direct I/O connections. The modules presented in this chapter have a configuration using RSLogix 5000 software, version 17, or later. The chapter contains the following main sections.

Topic	Page
Set Up the Hardware	60
Create the Example Application	61
Configure the I/O Modules	62
Add the Local EtherNet/IP Bridge to the I/O Configuration	62
Add the POINT I/O Adapter to the I/O Configuration	65
Add the POINT I/O Modules and Configure for Rack-optimization Connection	69
Add the POINT I/O Modules and Configure for Enhanced Rack-optimization Connection	73
Add the POINT I/O Module and Configure For Direct Connection	76
Download the Program to the Controller	79
Verify the Module Chassis Size	80
Access Module Data	83
Chapter Summary	83



ATTENTION: Check the Product Compatibility and Download Center (PCDC) to verify the compatibility between your POINT I/O module and the POINT I/O adapter.

(1) From version 21 onwards, RSLogix 5000 is known as Logix Designer.

Set Up the Hardware

The following section describe how to set up the I/O Hardware.

Set Up the POINT I/O Hardware

In this example, a ControlLogix chassis contains the L63 controller in slot 1 and a 1756-ENBT bridge module in slot 3. In this example, we mounted the 1734-AENTR adapter on a DIN rail in slot 0, with a 1734-OW2/C relay output module in slot 1, a 1734-OV4E/C sink output module in slot 3, and two other POINT I/O modules which will not be controlled by this Logix controller in slots 2 and 4.

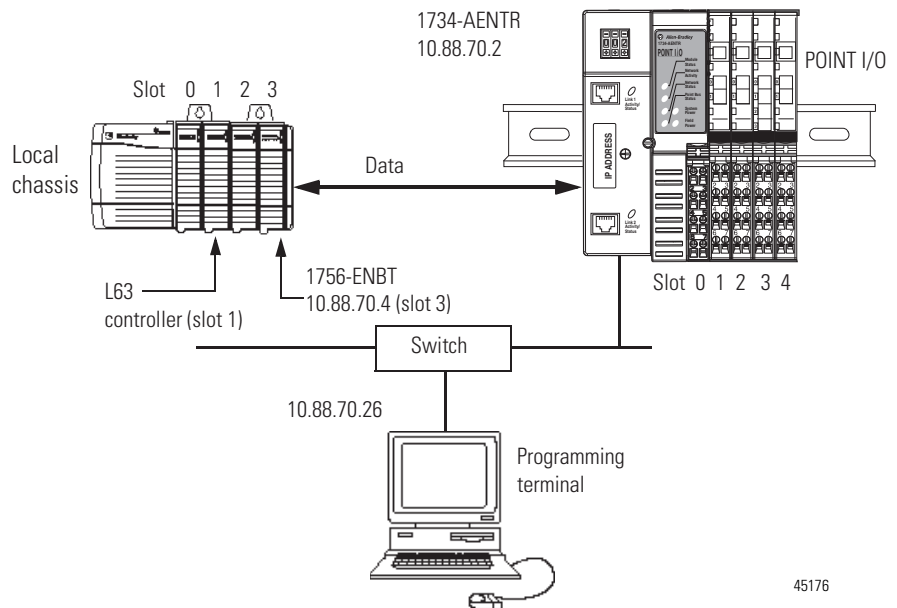

To work along with this example, set up your system as shown in the figure.

- Note that in the example application, the Logix controller and 1756-ENBT module (firmware revision 4.006 or later) we assume are in the slots shown in the figure.
- Verify the IP addresses for your programming terminal, 1756-ENBT module, and I/O adapter.
- Verify the position (slot) of the I/O modules on the DIN rail.
- Verify that you properly connected all wiring and cabling.
- Make sure you configured your communication driver (such as AB_ETH-1 or AB-ETHIP-1) in the RSLinx software. [See Configure the RSLinx Ethernet Communication Driver on page 113.](#)

Create the Example Application

Perform the following steps to create the example application:

1. Start the RSLogix 5000 Enterprise Series software.
The RSLogix 5000 software main dialog opens.
2. From the File menu, select New.

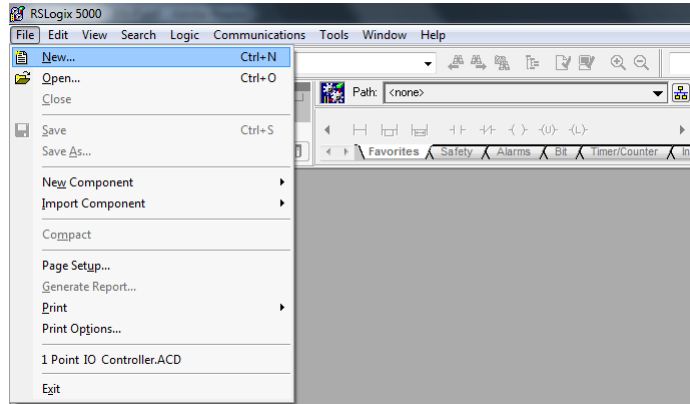

3. The New Controller dialog opens.

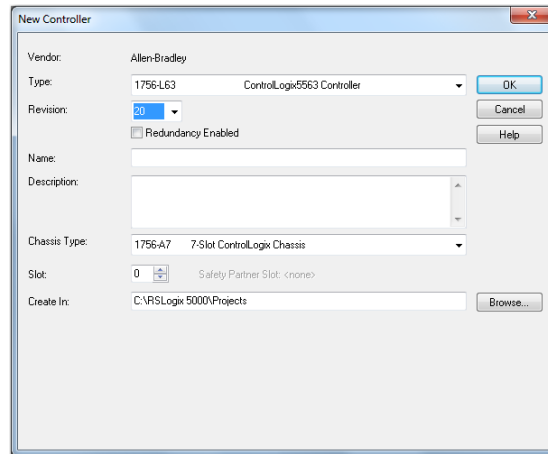

4. Enter an appropriate Name for the Controller, for example, POINT_IO_Controller.
5. Select the following:
 - Revision
 - Chassis Type
 - Slot number
 - Description (optional)

Note: RSLogix 5000 software, revision 18 and later includes enable redundancy. To use redundancy in your system, select the Redundancy Enabled checkbox. This example does not use redundancy.

6. Complete the Create In entry by selecting the folder where you want to save the file.
7. Click OK.

Configure the I/O Modules

You now add the I/O modules to the controller's I/O configuration performing these procedures:

- Add the local 1756-ENBT Bridge module to the I/O configuration.
- Add the adapter as a child of the 1756-ENBT module on the Ethernet network.
- Add the I/O modules as children of the adapter.

IMPORTANT

Click the Help button on the configuration dialogs shown in this section if you need assistance in selecting and setting the parameters.

Add the Local EtherNet/IP Bridge to the I/O Configuration

1. Right-click the I/O Configuration folder in the project dialog and select New Module.

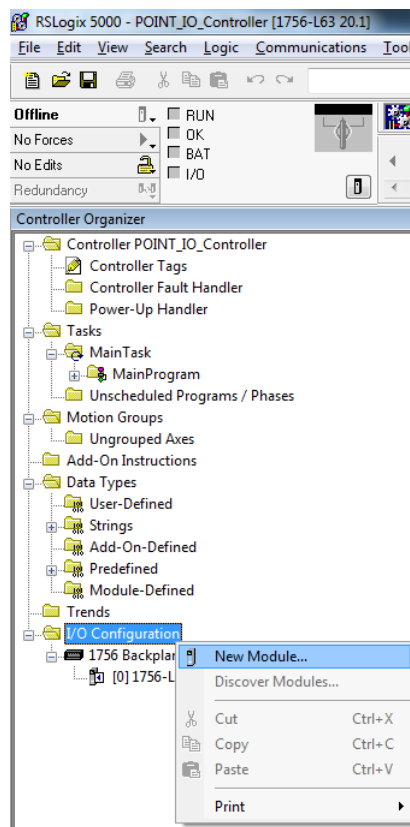

The Select Module Type dialog opens.

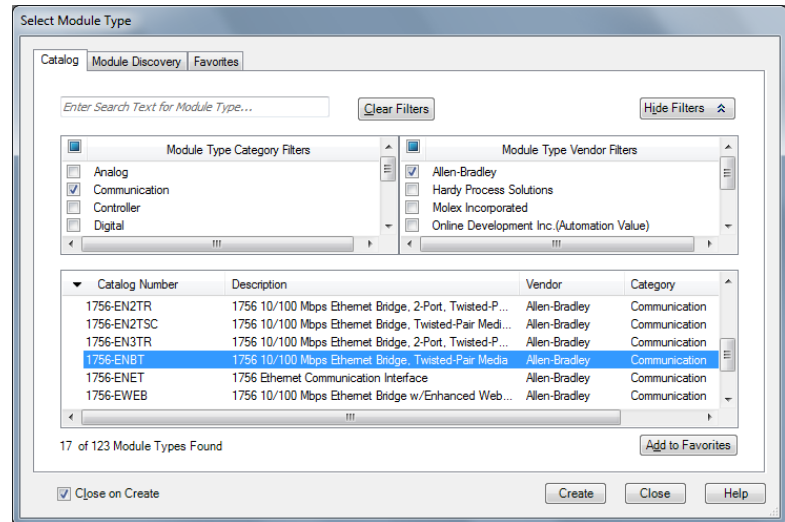

2. Select the appropriate Module Type filter Category (for the example we selected Communication), and Module Type Vendor (for the example we selected Allen-Bradley).

TIP

In the Select Module Type dialog, you have options to search for a specific module, add modules to a Favorites list, filter by Category and/or Vendor, Hide and Show Filters, use Module Discovery, sort by vendor, or access your Favorites list.

Note: to select only one category you will need to unselect those already selected.

3. From the list of adapters displayed, select the 1756-ENBT EtherNet/IP Bridge and click Create.

The New Module dialog opens.

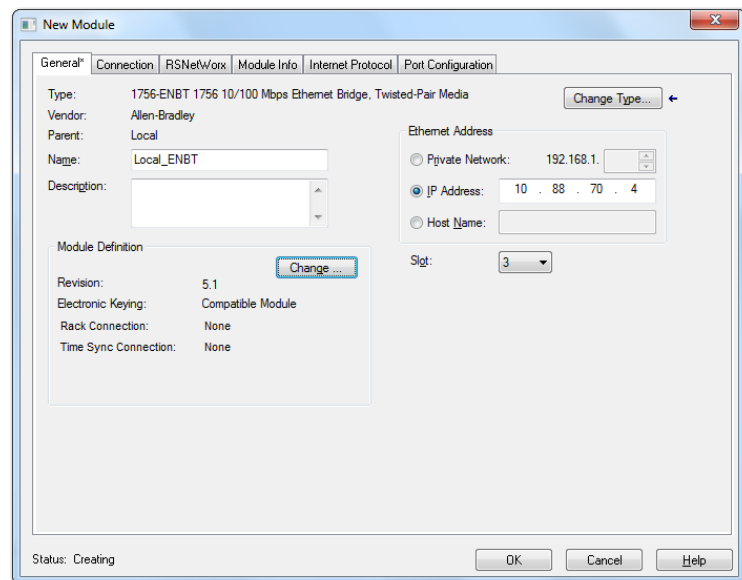

4. Enter values for Name, IP Address, and Slot, noting that we used the following values:

Name	Local_ENBT
IP Address	10.88.70.4
Slot	3

Note the module definition properties on the bottom left of the New Module dialog. You have the option to change these properties by clicking the Change button. Some of the properties cannot be modified while pending edits exists.

To change the default module properties,

5. Click Change...
The Module Definition dialog opens.

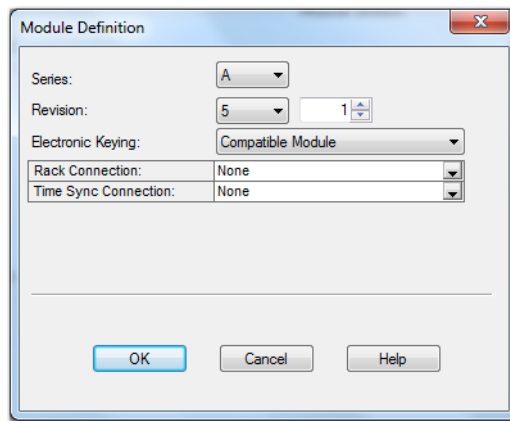

6. Enter or select values for Series, Revision, Electronic Keying, Rack Connection, and Time Sync Connection, noting that we used the following values:

Series	A
Revision	5.1
Electronic Keying	Compatible Module
Rack Connection	None
Time Sync Connection	None

7. Click OK to accept the configuration.

The module appears indented under the I/O Configuration folder.

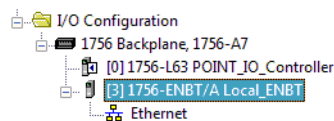

Add the POINT I/O Adapter to the I/O Configuration

Next, you must add the I/O adapter as a child of the local 1756-ENBT module.

1. In the Project dialog, right-click the local 1756-ENBT module under the I/O Configuration folder, and select New Module from the dialog.

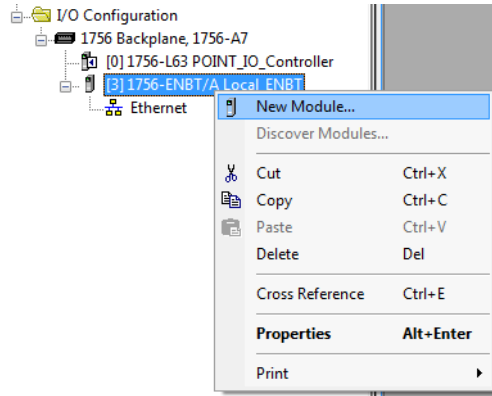

The Select Module Type dialog opens.

2. Select the appropriate Module Type filter Category (for the example we selected Communication), and Module Type Vendor (for the example we selected Allen-Bradley).

Note: to select only one category you will need to unselect those already selected.

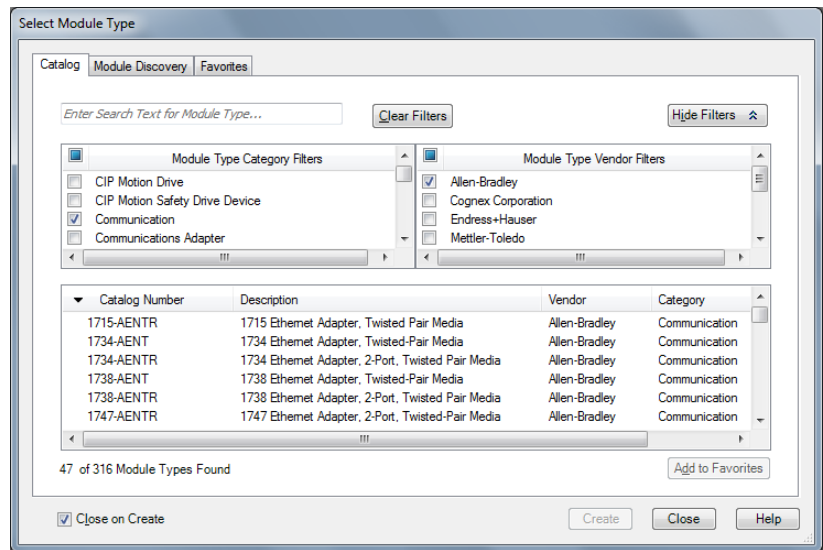

TIP

In the Select Module Type dialog, you have options to search for a specific module, add modules to a Favorites list, filter by Category and/or Vendor, Hide and Show Filters, use Module Discovery, sort by vendor, or access your Favorites list.

3. Select your adapter (in this example, we use the 1734-AENTR/C) from the list and click Create.
The New Module dialog opens.

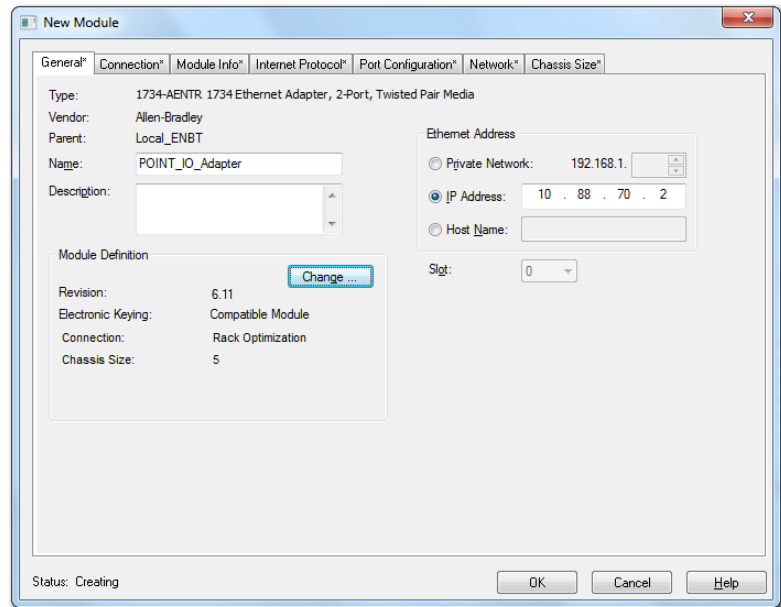

4. Select the General Tab and enter the module details, noting that we used the following values.

Name	POINT_IO_Adapter
IP Address	10.88.70.2

IMPORTANT The Slot field appears grey because the slot is automatically 0 for the I/O adapter.

5. Click Change...
The Module Definition dialog opens.

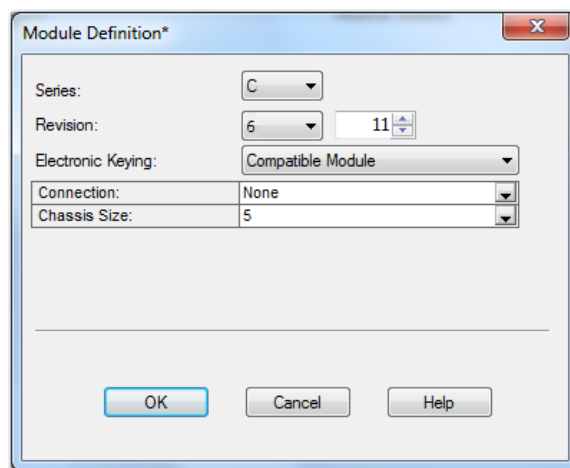

- Enter or select values for Series, Revision, Electronic Keying, Connection, and Chassis Size, noting that we used the following values:

Series	C
Connection	Rack Optimization
Chassis Size	5
Electronic Keying	Compatible Module
Revision	6.11

IMPORTANT The chassis size value equals 1 for the adapter plus the number of I/O modules installed (physically present on the I/O backplane).

Connection choices include:

- None – the adapter makes a direct connection to each of the modules referenced by the data. RPI is disabled in this case.
 - Rack optimization– digital I/O data is collected into a rack image. This does not include analog or specialty I/O modules.
 - Enhanced rack optimization – digital, analog, and specialty I/O data is collected into a rack image.
 - Listen only - rack optimization– read or verify data only, but does not control the modules. When you have multiple controllers - one controller is used to control and the other controllers are used to monitor.
- Because we are making a mixed connection (both a direct connection and rack-optimization connection), choose Rack Optimization as the Connection for the 1734-AENTR/C adapter and click OK.

A dialog box opens.

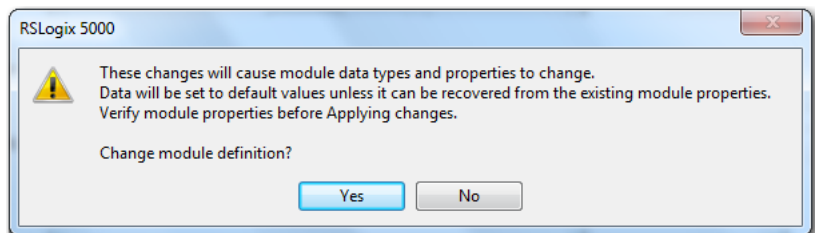

- Click Yes.

9. In the New Module screen select the Connection Tab.

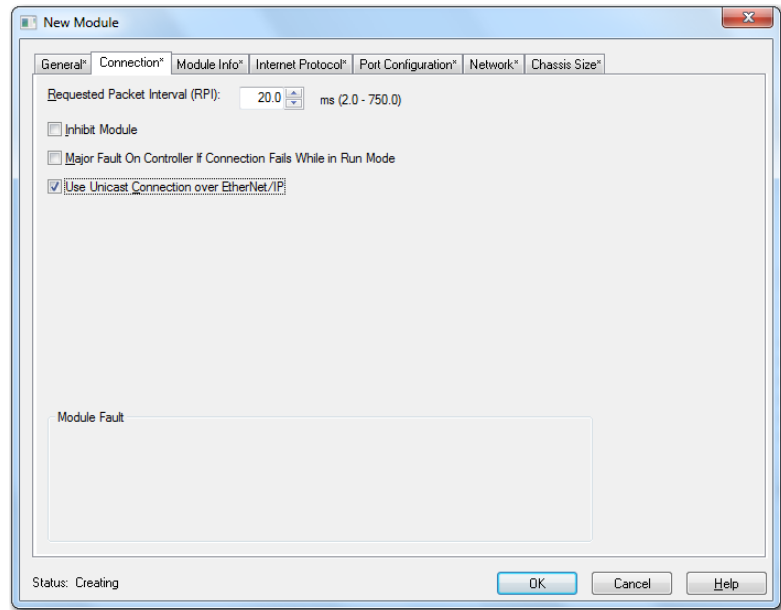

10. Verify that the Requested Packet Interval (RPI) used for the rack-optimization connection to the I/O modules is appropriate for your system (20.0 ms for this example). If not, change it to the correct value.

IMPORTANT To avoid overloading the adapter, it is recommended that the RPI be no less than 10.0 ms for rack-optimization and enhanced rack-optimization connections, and 50.0 ms for direct connections.

11. Click OK to accept the configuration.
The 1734-AENTR/C adapter appears indented under the local 1756-ENBT bridge module in the I/O Configuration folder.

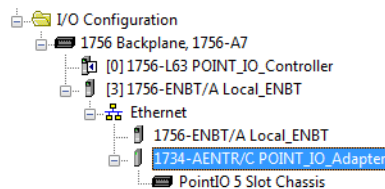

Add the POINT I/O Modules and Configure for Rack-optimization Connection

You must now add the POINT I/O modules to the I/O Configuration List under the adapter. In this example, the digital input and output modules are configured for rack optimization.

Add the Digital Relay Output Module

1. Right-click the adapter in the I/O Configuration folder and select New Module.

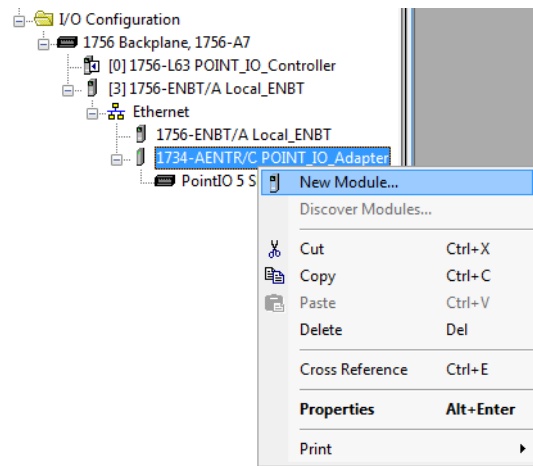

The Select Module Type dialog displays.

2. Select the appropriate filter for Module Type Category (for the example we selected Digital) and Module Type Vendor (for the example we selected Allen-Bradley).

Note: to select only one category you will need to unselect those already selected.

- From the modules listed select the 1734-OW2 digital relay output module and click Create.

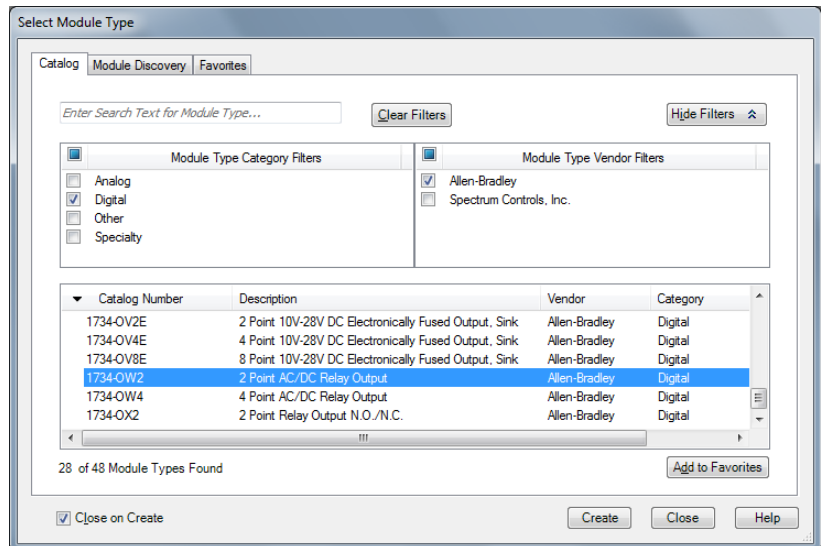

TIP In the Select Module Type dialog, you have options to search for a specific module, add modules to a Favorites list, filter by Category and/or Vendor, Hide and Show Filters, use Module Discovery, sort by vendor, or access your Favorites list.

The New Module dialog opens.

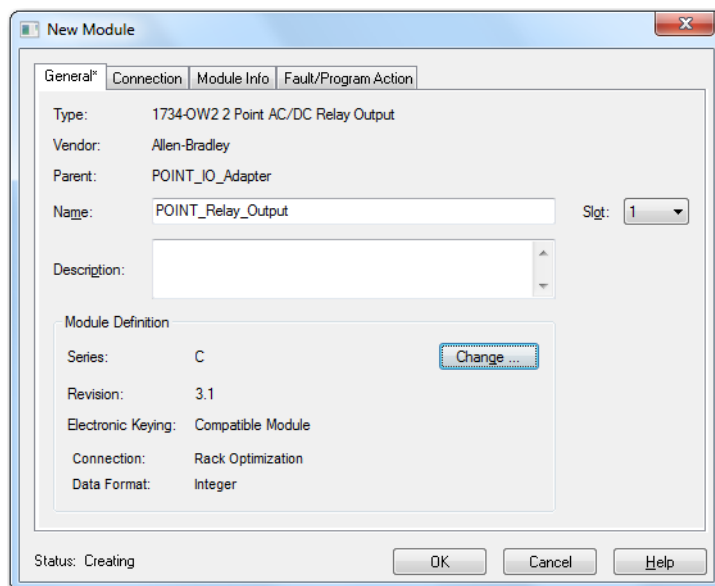

- Enter values for Name and Slot, noting that we used the following values.

Name	POINT_Relay_Output
Slot	1

Note the module definition properties on the bottom left of the New Module dialog. You have the option to change these properties by clicking the Change... button. Some of the properties cannot be modified while pending edits exist.

5. Select Change...
The Module Definition dialog displays.

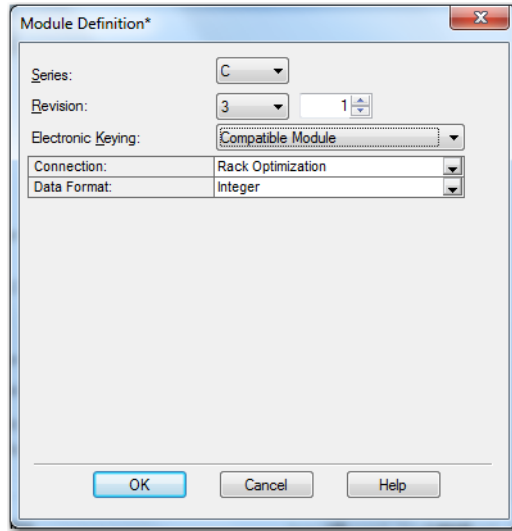

6. Change the Connection from Data to Rack Optimization and click OK. Note that the requested packet interval (RPI) is the same as was chosen by the adapter. You use this value for the rack-optimization connection to the I/O modules.

IMPORTANT To avoid overloading the I/O adapter, we recommend that the RPI be no less than 10 ms for rack-optimization and enhanced rack-optimization connections, and 50 ms for direct connections.

7. In the New Module screen select the Connection tab and verify that the Requested Packet Interval (RPI) used for the rack-optimization connection to the I/O modules is appropriate for your system (20.0 ms for this example). If not, change it to the correct value.

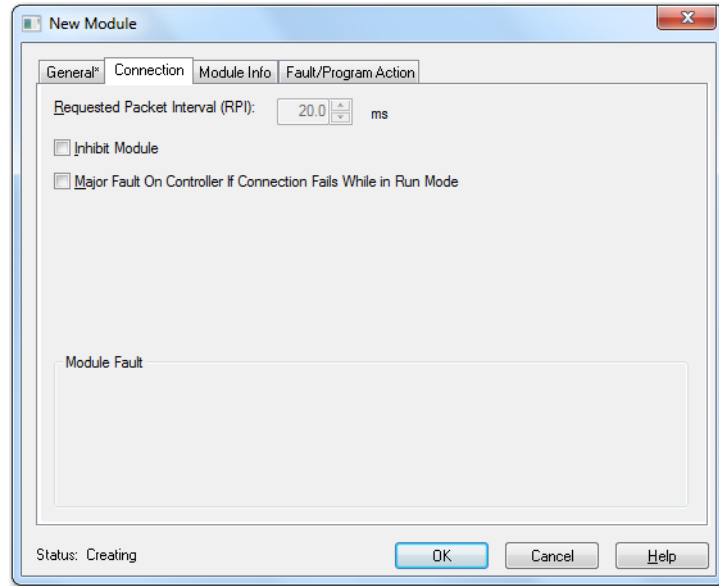

8. Click OK to accept the configuration.
The digital output module appears indented under the local 1734-AENTR/C adapter in the I/O Configuration folder.

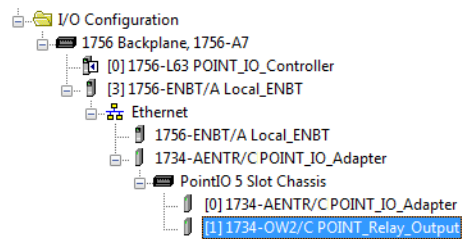

Add the POINT I/O Modules and Configure for Enhanced Rack-optimization Connection

You must now add the POINT I/O modules to the I/O Configuration List under the adapter. In this example, the digital input and output modules are configured for enhanced rack optimization.

Add the Digital Relay Output Module

1. Right-click the adapter in the I/O Configuration folder and select New Module.

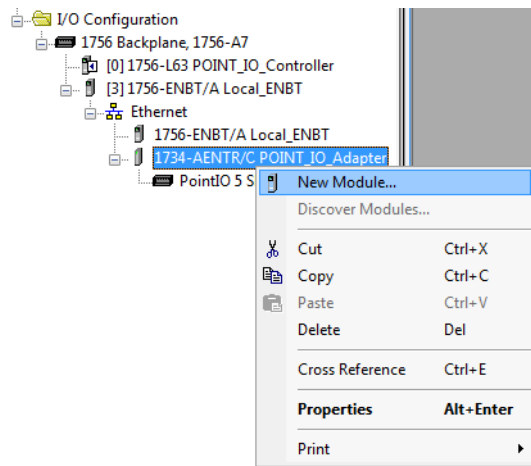

The Select Module Type dialog displays.

2. Select the appropriate filter for Module Type Category (for the example we selected Digital) and Module Type Vendor (for the example we selected Allen-Bradley).

Note: to select only one category you will need to unselect those already selected.

- From the modules listed select the 1734-OW2 digital relay output module and click Create.

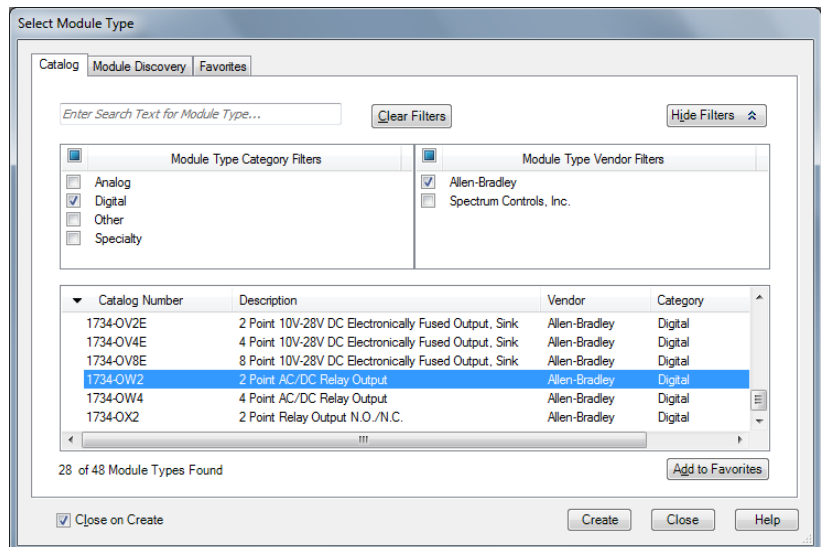

The New Module dialog opens.

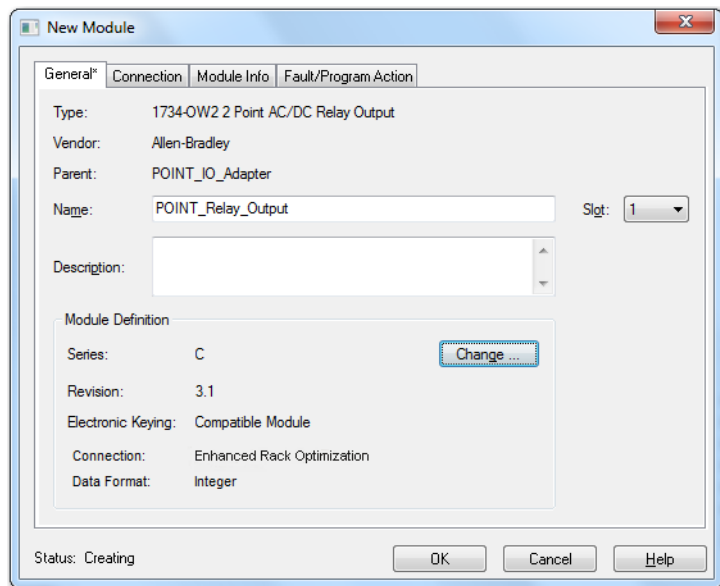

- Enter values for Name and Slot, noting that we used the following values.

Name	POINT_Relay_Output
Slot	1

Note the module definition properties on the bottom left of the New Module dialog. You have the option to change these properties by clicking the Change... button. Some of the properties cannot be modified while pending edits exist.

5. Select Change...
The Module Definition dialog displays.

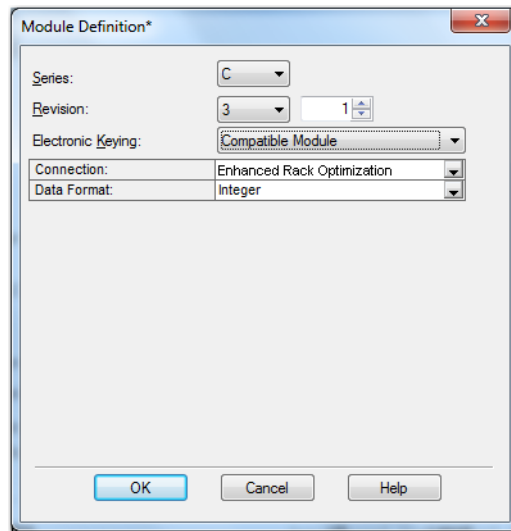

6. Note that the requested packet interval (RPI) is the same as was chosen by the adapter. You use this value for the enhanced rack-optimization connection to the I/O modules.

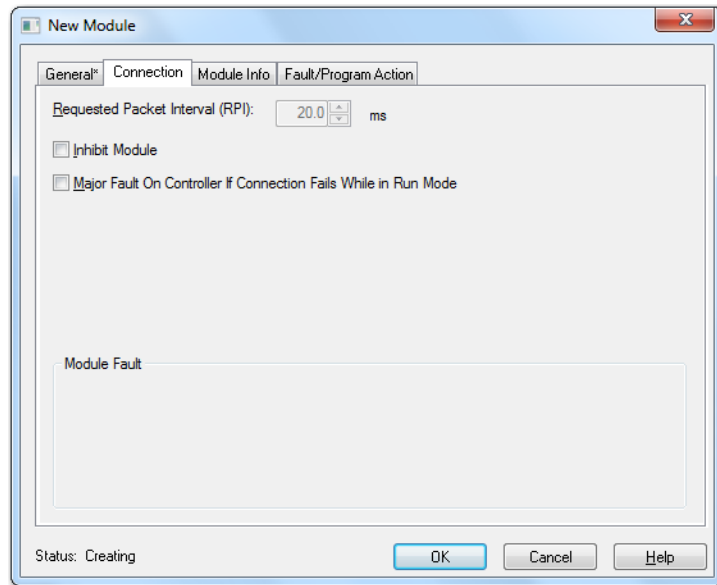

IMPORTANT To avoid overloading the I/O adapter, we recommend that the RPI be no less than 10 ms for rack-optimization and enhanced rack-optimization connections, and 50 ms for direct connections.

- Click OK to accept the configuration.
The digital output module appears indented under the local 1734-AENTR/C adapter in the I/O Configuration folder.

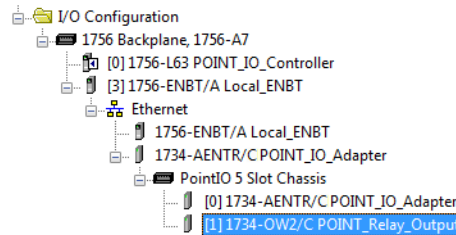

Add the POINT I/O Module and Configure For Direct Connection

Add The Digital Sink Output Module

- Right-click the POINT I/O Chassis in the I/O Configuration folder and select New Module.

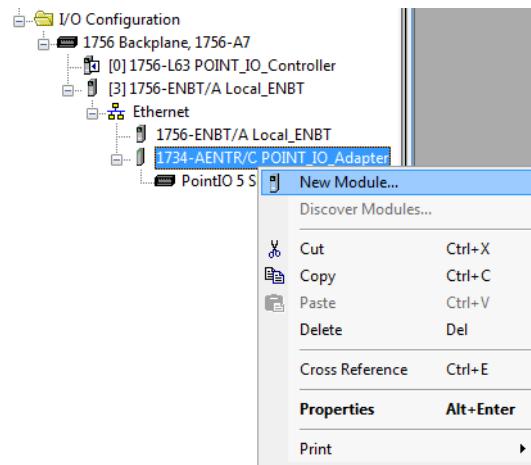

The Select Module Type dialog opens.

- Select the appropriate filter for Module Type Category (for the example we selected Digital) and Module Type Vendor (for the example we selected Allen-Bradley).
Note: to select only one category you will need to unselect those already selected.

IMPORTANT If you exceed the adapter chassis size trying to add more modules than you configured, the New Module selection appears dim and is disabled. Increase the adapter chassis size to add more I/O modules.

3. From the modules listed select the 1734-OV4E/C Digital Sink Output module and click Create.

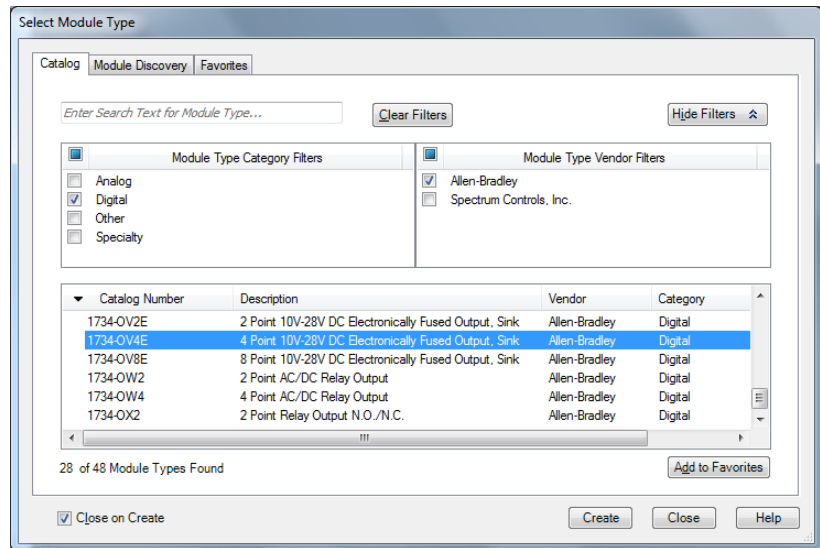

TIP In the Select Module Type dialog, you have options to search for a specific module, add modules to a Favorites list, filter by Category and/or Vendor, Hide and Show Filters, use Module Discovery, sort by vendor, or access your Favorites list.

The New Module dialog opens.

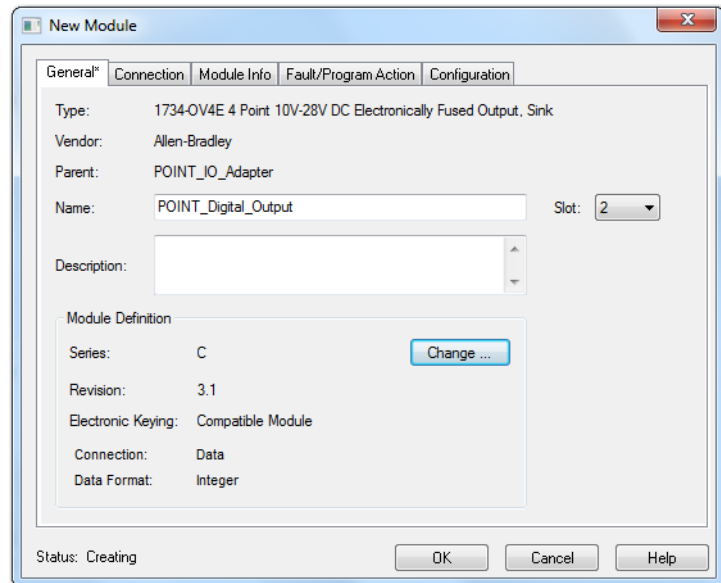

4. From the New Module dialog, complete the following:
 - Enter a value for Name.
 - Enter a value for Slot.

5. Select Change...
The Module Definition dialog displays.

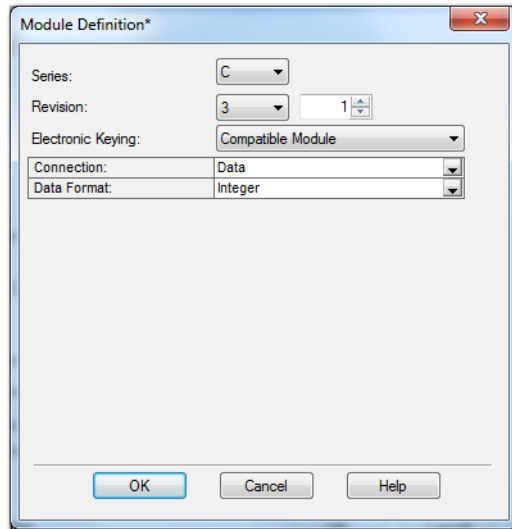

6. Select Data as the Connection and click OK.
This configures the controller to make a Direct I/O Connection to the module.
7. From the New Module dialog, select the Connection tab to set the RPI value. RPI is selectable since it is a direct connection.

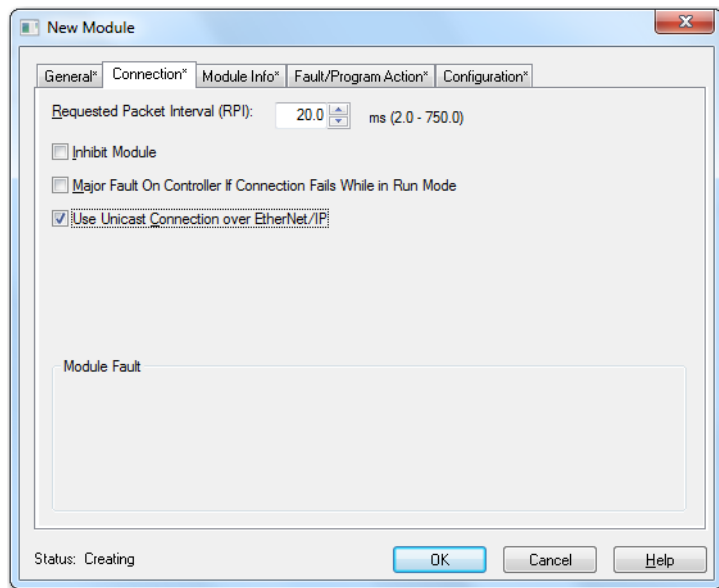

Note that the RPI is selectable and has a default value. Because we are making a direct connection to each I/O module, we must specify an RPI to determine how often the data is exchanged with the adapter for each module

IMPORTANT To avoid overloading the I/O adapter, we recommend that the RPI be no less than 10 ms for rack-optimization and enhanced rack-optimization connections, and 50 ms for direct connections.

8. From the New Module dialog, enter 50 for the Requested Packet Interval (RPI).
9. Keep the following unchecked.
 - a. Inhibit Module
 - b. Major Fault on Controller If Connection fails While in Run Mode
10. Click OK.
11. Choose File → Save and enter the name and location of the file.

Download the Program to the Controller

Follow this procedure to download the program we just saved to the ControlLogix controller.

1. From the main menu, choose Communications>Who Active.
2. From the Who Active dialog, navigate to select the slot where the controller is located in the chassis.

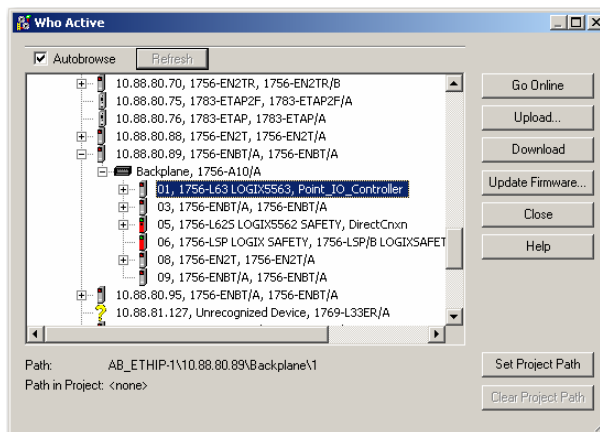

3. Click Set Project Path.

4. Click Download.
The Download dialog opens.

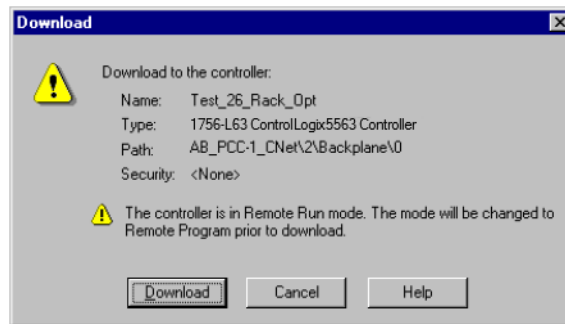

5. From the Download dialog, click Download.
The Downloading dialog displays the download progress.

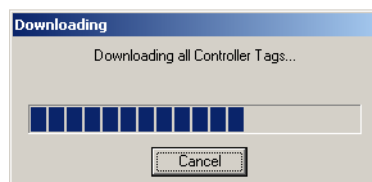

Notice that the 1756-ENBT Bridge is now online.

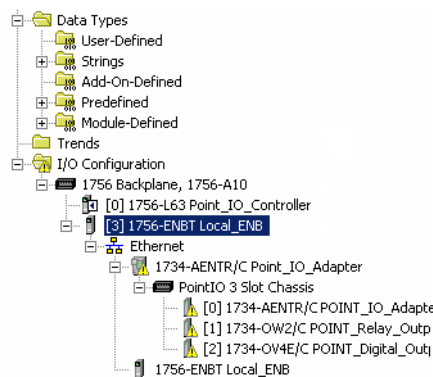

If yellow triangles are present, see the following section.

Verify the Module Chassis Size

You have now built the I/O tree and the RSLogix 5000 software uses the chassis size from the General tab of the adapter for the rack-optimization I/O connection. Now you need to configure this new chassis size value into the adapter non-volatile memory. This procedure synchronizes the chassis size value from the RSLogix 5000 software into the adapter hardware. You must be online to perform this procedure.

1. Verify that the RSLogix 5000 software is online.
2. Right-click the name of the adapter under I/O Configuration in the Project dialog.
3. Select Properties.

4. Click the Connection tab.
The Module Fault error code displays at the bottom of the Connection tab.

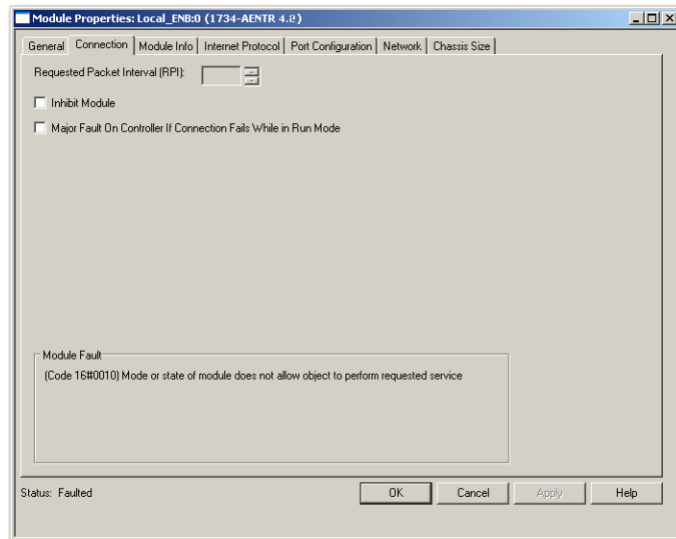

5. Click the Chassis Size tab.
6. Click Set Chassis Size in Module.

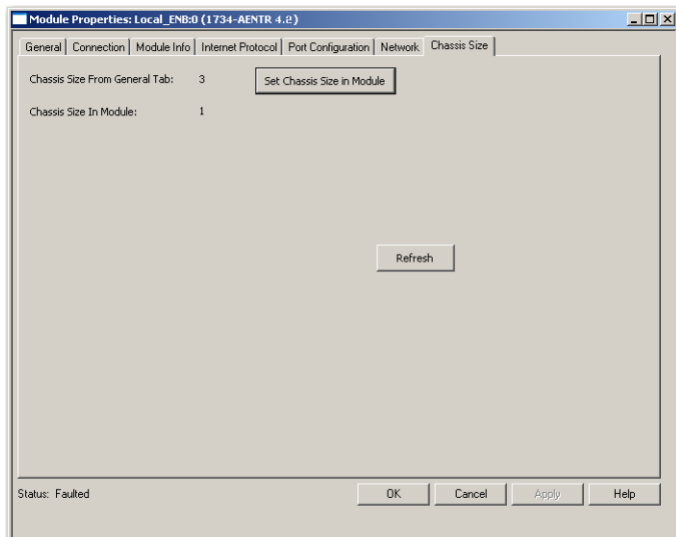

7. Read and acknowledge the warning dialog.

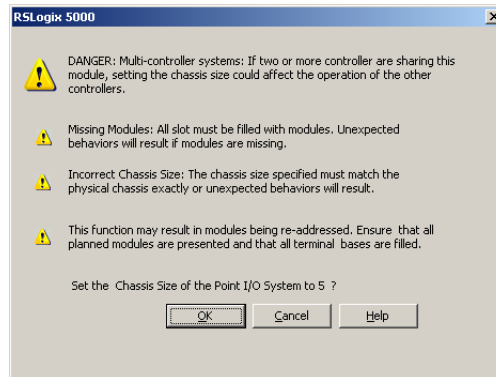

8. Click OK to continue.

9. Notice the chassis size in the module is modified to 5.

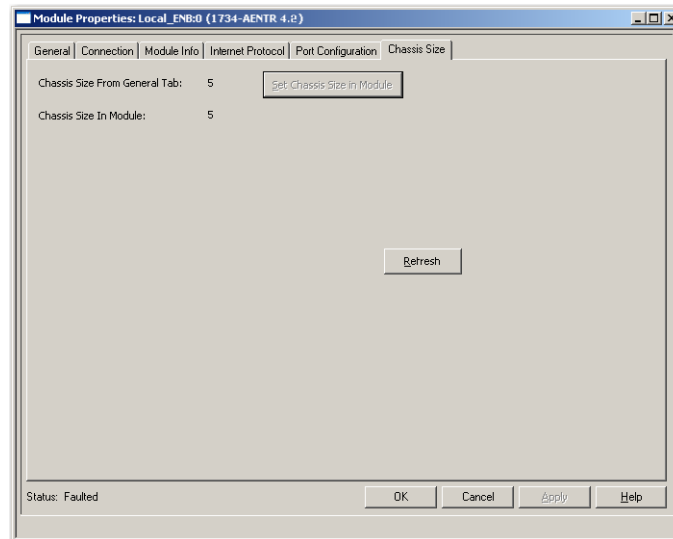

10. Click OK.

At this point, your POINTBus status LED should be solid green. All the yellow triangles in your I/O configuration should be gone.

11. Click OK to close the dialog.

12. Click File → Save to save the project.

Access Module Data

Use the following information to use the I/O adapter data in the ladder logic program:

- POINT_IO_Adapter — the name you gave to your EtherNet adapter
- # — slot number of POINT I/O module
- C — configuration, I = input, O = output

Name	Value	Force Mask	Style	Data Type
IO_Adapter1.C	(...)	(...)		AB:1734_DD2.C:0
IO_Adapter1.O	2#0000_0000		Binary	SINT
IO_Adapter2.C	(...)	(...)		AB:1734_DD0V4.C:0
IO_Adapter2.I	(...)	(...)		AB:1734_D0B8:I:0
IO_Adapter2.O	(...)	(...)		AB:1734_D08:O:0
IO_AdapterI	(...)	(...)		AB:1734_5SLOT:I:0
IO_AdapterI.SlotStatusBi...	2#1111_1111_1111_1111_1111_1111_1111_1101		Binary	DINT
IO_AdapterI.SlotStatusBi...	2#1111_1111_1111_1111_1111_1111_1111_1111		Binary	DINT
IO_AdapterI.Data	(...)	(...)	Binary	SINT[5]
IO_Adapter.O	(...)	(...)		AB:1734_5SLOT:O:0

Use the controller tags in your ladder program to read input data or write output data.

- For ControlLogix controller information, refer to ControlLogix System User Manual, publication [1756-UM001](#).
- Slot Status Bits: The Slot Status bits display the connection status for each of the POINT I/O modules that use a rack-optimization connection.
 - Bit 0 is reserved for the adapter and always reports a value of 1.
 - Each of the other bits (1 to 63) correspond to a POINT I/O module that you install in the POINT I/O backplane.
 - In this example, we configured the 1734-AENTR adapter for both rack-optimization and direct connections. The slot status bits indicate that we installed the module in slot 2 with it operating correctly:

0 = module participating with no errors and

1 = module not participating or connection error (typically, module removed/missing)

Chapter Summary

This chapter provided instructions on configuring an AENTR Adapter for Direct Connection, Rack-Optimization, and Enhanced Rack-Optimization in RSLogix 5000 Software. It included information about hardware setup; configuring the I/O Modules; adding an I/O adapter to the I/O configuration; configuring for rack-optimization connections; configuring for direct connections; and accessing module data.

Notes:

Troubleshoot the Adapter

This chapter describes the different status indicators available in the 1734 POINT I/O and 1738 ArmorPOINT I/O EtherNet/IP adapters and how to interpret these indicators to help troubleshoot the modules.

The following table lists where to find specific information

Topic	Page
Interpret the Status Indicators	85
Status Indicators for POINT I/O Adapters	85
Status Indicators for ArmorPOINT I/O Adapters	88

Interpret the Status Indicators

The 1734 POINT I/O and 1738 ArmorPOINT I/O EtherNet/IP adapters have the following status indicators:

- Network, Module, POINTBus, and EtherNet/IP Link Status
- System Power
- Field/Adapter Power

Status Indicators for POINT I/O Adapters

The following describes the status indicators on the 1734-AENTR.

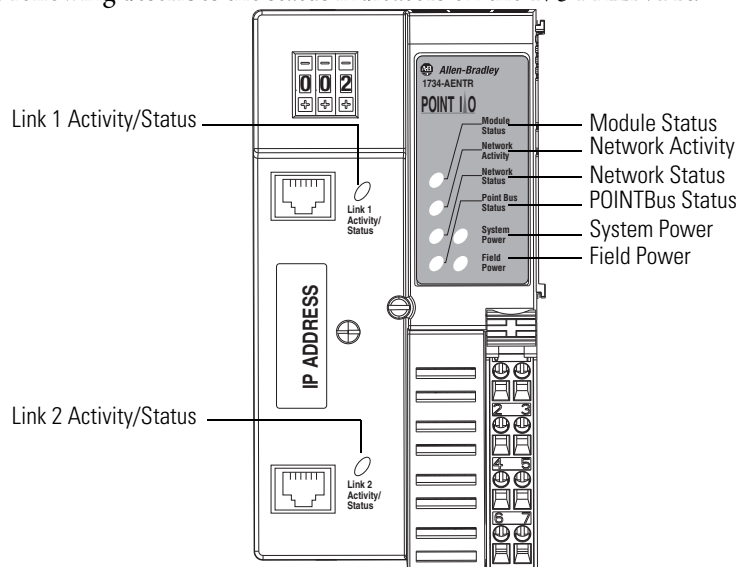

44848

Status Indicators for 1734-AENTR Adapter

Indicator	Status	Description
Module Status	Off	No power applied to device
	Flashing green	Device needs commissioning due to missing, incomplete, or incorrect configuration.
	Solid green	Device operating normally
	Flashing red	Recoverable fault. Complete firmware update, verify address switches.
	Solid red	Unrecoverable fault, may require device replacement
	Flashing red/green	Module self-test
Network Status	Off	Device is not on-line: <ul style="list-style-type: none"> • Device has not completed dup_MAC_id test. • Device not powered - check module status indicator
	Flashing green	Device is on-line but has no CIP connections in the established state.
	Solid green	Device on-line and has CIP connections in the established state.
	Flashing red	One or more CIP connections in timed-out state. Check for I/O module failure and controller operation. Note: This does not apply to POINTGuard I/O connection timeout.
	Solid red	Duplicate IP address detected. Verify IP address setting and correct, as needed.
	Flashing red/green	Module self-test
Network Activity	Off	No link established with Port 1 or Port 2.
	Flashing green	Transmit or receive activity present on Port 1 and/or Port 2 @ 100 Mb. Transmit or receive activity present on Port 1 and/or Port 2. One port @ 100 Mb and the other port @ 10 Mb.
	Solid green	Link established with Port 1 and/or Port 2 @ 100 Mb. Link established with Port 1 and Port 2. One port @ 100 Mb and the other port @ 10 Mb.
	Flashing yellow	Transmit or receive activity present on Port 1 and/or Port 2 @ 10 Mb.
	Solid yellow	Link established with Port 1 and/or Port 2 @ 10 Mb.
	Link 1 or Link 2 Activity / Status	Off
Flashing green		Transmit or receive activity present on indicated port @ 100 Mbps.
Solid green		Link established @ 100 Mbps.
Flashing yellow		Transmit or receive activity present on indicated port @ 10 Mbps.
Solid yellow		Link established @ 10 Mbps.

Status Indicators for 1734-AENTR Adapter

Indicator	Status	Description
POINTBus Status	Off	Device is not online. Device has not completed Dup_MAC_ID test. Device not powered - check module status indicator.
	Flashing green	Device is online but has no connections in the established state. Firmware (NVS) update in progress.
	Solid green	Adapter online with connections established.
	Flashing red	Recoverable fault occurred: <ul style="list-style-type: none"> • At cycle power, the number of expected modules does not equal the number of modules present. • A module is missing. • Node fault (I/O connection timeout) occurred.
	Solid red	Unrecoverable fault occurred - the adapter is bus off.
	Flashing red/green	LED powerup test is in progress.
System Power	Off	Not active. Adapter power is off or there is a DC-DC converter problem.
	Solid green	System power is on. DC-DC converter output is active (5V).
Field Power	Off	Not active. Adapter power is off.
	Solid green	Power is on. 24V DC power input is present

Status Indicators for ArmorPOINT I/O Adapters

The following describes the status indicators on the 1738-AENTR.

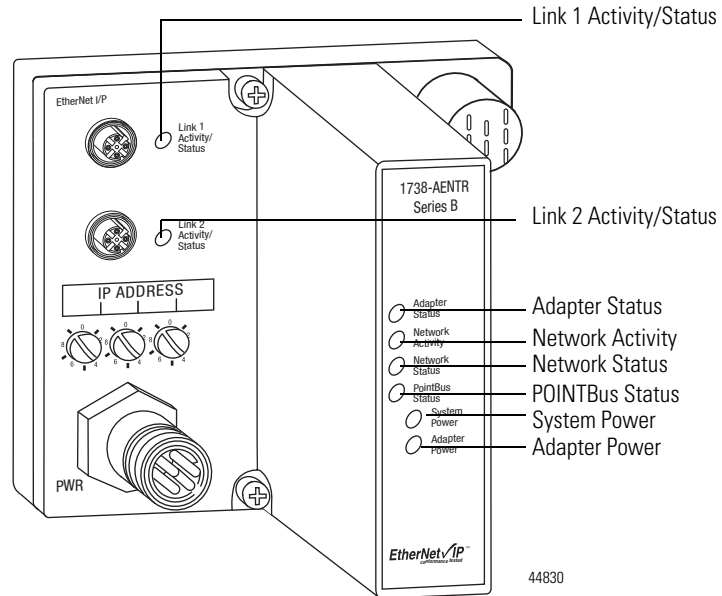

Status Indicators for 1738-AENTR Adapter

Indicator	State	Description
Adapter Status	Off	No power applied to device
	Flashing green	Device needs commissioning due to missing, incomplete, or incorrect configuration.
	Solid green	Device operating normally
	Flashing red	Recoverable fault: <ul style="list-style-type: none"> • Complete firmware update • Verify address switches.
	Solid red	Unrecoverable fault: <ul style="list-style-type: none"> • Self-test failure (checksum failure, RAM test failure at cycle power) • Firmware fatal error.
	Flashing red/green	Device is in self-test
Network Activity	Off	No link established with Port 1 or Port 2.
	Flashing green	Transmit or receive activity present on Port 1 and/or Port 2 at 100 Mbps. Transmit or receive activity present on Port 1 and/or Port 2. One port at 100 Mbps and one port at 10 Mbps.
	Solid green	Link established with Port 1 and/or Port 2 at 100 Mbps. Link established with Port 1 and Port 2. One port at 100 Mbps and one port at 10 Mbps
	Flashing yellow	Transmit or receive activity present Port 1 and/or Port 2 at 10 Mbps.
	Solid yellow	Link established with Port 1 and/or Port 2 at 10 Mbps.

Status Indicators for 1738-AENTR Adapter

Indicator	State	Description
Network Status	Off	Device not initialized. Device does not have an IP address.
	Flashing green	No CIP connections present. Device has an IP address, but no CIP connections are established.
	Solid green	CIP connections present. Device online and has an IP address, and CIP connections are established.
	Flashing red	One or more CIP connections in timed-out state. Check for I/O module failure and controller operation.
	Solid red	Duplicate IP address detected. Verify IP address setting and correct, as needed.
	Flashing red/green	Device is in self-test.
Link 1 or Link 2 Activity/Status	Off	No link established.
	Flashing green	Transmit or receive activity present at 100 Mbps.
	Solid green	Link established at 100 Mbps
	Flashing yellow	Transmit or receive activity present at 10 Mbps.
	Solid yellow	Link established at 10 Mbps.
System Power	Off	Not active; adapter power is off, or DC-DC converter problem is present.
	Solid green	System power is on; DC-DC converter output is active (5V).
Adapter Power	Off	Not active; adapter power is off
	Solid green	Power is on; 24V input is present.
POINTBus Status	Off	Device is not online: <ul style="list-style-type: none"> • Device has not completed Dup_MAC_ID test. • Device not powered - check Adapter Status indicator.
	Flashing green	Device is online but has no connections in the established state. Firmware (NVS) update in progress.
	Solid green	Device is online and has connections in the established state.
	Flashing red	Recoverable fault occurred: <ul style="list-style-type: none"> • At cycle power, the number of expected modules does not equal the number of modules present. • A module is missing. • Node fault (I/O connection timeout) occurred.
	Solid red	Unrecoverable fault has occurred: <ul style="list-style-type: none"> • POINTBus is off.
	Flashing red/green	LED cycle power test present.

Notes:

Specifications

General Specifications

The 1734-AENTR and 1738-AENTR adapters have the following general specifications.

General Specifications

Attributes	1734-AENTR	1738-AENTR
Expansion I/O capacity, max	<ul style="list-style-type: none"> •63 modules •Up to 5 rack-optimization (for digital modules only) and/or enhanced rack-optimization (for digital, analog, and specialty modules – applies to 1734-AENTR only) connections •31 direct connections⁽¹⁾ •Backplane current output = 0.8 A. •Actual number of modules can vary. •Add together the current requirements for the modules you want to use to make sure they do not exceed the amperage limit of 0.8 A for the adapter. •Backplane current can be extended beyond 0.8 A by using 1734 or 1738-EP24DC backplane extension power supplies and, as required, 1734 or 1738-FPD modules. •Add multiple 1738-EP24DC and 1738-FPD modules to reach the 63 module max. 	
POINTBus current requirements, max	<ul style="list-style-type: none"> •50 mA (Catalog number 1734-IB4D) •75 mA (Catalog numbers 1734-IB2, 1734-IB4, 1734-IB8, 1734-IV2, 1734-IV4, 1734-OB2, 1734-OB4, 1734-OB8, 1734-OB2E, 1734-OB2EP, 1734-OB4E, 1734-OB8E, 1734-OV2E, 1734-OV4E, 1734-232ASC, 1734-485ASC, 1734-ARM, 1734-IV8, 1734-OV8E, 1734-IE4C, 1734-IE8C, 1734-OE4C, 1734-IA4, 1734-IM4, 1734-OA4, 1734-IR2E, 1734-IE2C, 1734-OE2C, 1734-IE2V, 1734-OE2V, 1734-IA2, 1734-IM2, 1734-OA2) •80 mA (Catalog number 1734-OW2, 1734-OW4) •100mA (Catalog numbers 1734-OX2, 1734-8CFG, 1734-4IOL) •110mA (Catalog number 1734-SSI) •160mA (Catalog numbers 1734-IJ2, 1734-IK2) •175mA (Catalog number 1734-IT2I) •180mA (Catalog numbers 1734-VHSC5, 1734-VHSC24) •220 mA (Catalog number 1734-IR2, 1734-IR2E) 	<ul style="list-style-type: none"> 50 mA (Catalog number 1738-IB4DM12) •75 mA (Catalog numbers 1738-OB2EM12, 1738-OB8EM8, 1738-OB2EPM12, 1738-OB4EM8, 1738-OB4EM12, 1738-OB8EM12, 1738-OB8EM23, 1738-IB2M12, 1738-IB4M12, 1738-IB4M8, 1738-IB8M8, 1738-IB8M12, 1738-IB8M23, 1738-IB16DM12, 1738-8CFGM8, 1738-8CFGM23, 1738-8CFGDLXM8, 1738-8CFGDLXM12, 1738-8CFGDLXM23, 1738-OV4EM12, 1738-IV4M12, 1738-IV8M8, 1738-IV8M12, 1738-IV8M23, 1738-IA2M12AC3, 1738-IA2M12AC4, 1738-OA2M12AC3, 1738-IE2CM12, 1738-IE4CM12, 1738-IE2VM12, 1738-OE2CM12, 1738-OE4CM12, 1738-OE2VM12) •80 mA (Catalog numbers 1738-OW4M12, 1738-OW4M12AC) •100mA (Catalog numbers 1738-8CFGM8, 1738-8CFGM12, 1738-8CFGM23, 1738-8CFGDLXM8, 1738-8CFGDLXM12, 1738-8CFGDLXM23) •110mA (Catalog number 1738-VHSC24M23) •150 mA (Catalog numbers 1738-OB16E25DS, 1738-OB16E19M23, 1738-OB16EM12) •160mA (Catalog number 1738-IJM23) •175mA (Catalog number 1738-IT2IM12) •220 mA (Catalog number 1738-IR2M12)
Module location	Starter module – left side of the system.	

(1) Maximum 31 direct connections for standard I/O or maximum 20 direct connections if any safety I/O module resides in the backplane.

General Specifications

Attributes	1734-AENTR	1738-AENTR
Status indicators	3 red/green status indicators on CPU: <ul style="list-style-type: none"> • Module Status • Network Status (Ports 1 and 2 combined) • POINTBus Status 1 green/yellow status indicator on CPU: <ul style="list-style-type: none"> • Network Activity (Ports 1 and 2) 2 green/yellow status indicators on base: <ul style="list-style-type: none"> • Link 1 Activity/Status • Link 2 Activity/Status 2 green power supply status indicators on DC-DC Converter: <ul style="list-style-type: none"> • System Power (5V DC to POINTBus Out) • Field Power (24V DC from Field In) 	3 red/green status indicators on CPU: <ul style="list-style-type: none"> • Module Status • Network Status (Ports 1 and 2 combined) • POINTBus Status 1 green/yellow status indicator on CPU: <ul style="list-style-type: none"> • Network Activity (Ports 1 and 2) 2 green/yellow status indicators on base: <ul style="list-style-type: none"> • Link 1 Activity/Status • Link 2 Activity/Status 2 green power supply status indicators on DC-DC Converter: <ul style="list-style-type: none"> • System Power (5V DC to POINTBus Out) • Adapter Power (24V DC from Field In)
Wire Size	Power connections: 0.34... 2.1 mm ² (22...14 AWG) solid or stranded copper wire rated @ 75 °C (167 °F) or greater, 1.2 mm (3/64 in.) insulation max or 90 °C (194 °F) for ControlLogix. Ethernet wiring: RJ45 connector according to IEC 60603-7, 2 or 4 pair Category 5e min cable according to TIA 568-B.1 or Category 5 cable according to ISO/IEC 24702.	
Power consumption, max	10.4 W @ 28.8V DC	
Wiring category ⁽¹⁾	1 – on communications ports 1 – on power ports	
Power dissipation, max	6.3 W @ 28.8V DC	
Input overvoltage protection	Reverse polarity protected	
Thermal dissipation, max	21.5 BTU/hr @ 28.8V DC	
Isolation voltage	50V (continuous), Reinforced Insulation Type, between all circuits. Type tested @ 500V AC for 60 s	50V (continuous), Basic Insulation Type. Type Tested @ 500V AC for 60 s: <ul style="list-style-type: none"> • Comm to system • Comm to user power • User power to system • User power to ground • System to ground
Field power supply	10...28.8V DC @ 10A	10...28.8V DC @ 10A
Field power output	10...28.8V DC @ 9A	10...28.8V DC @ 9A
Module input	10...28V DC @ 1000 mA	10...28V DC @ 1000 mA
Dimensions (HxWxD), approx.	76.2 x 73.0 x 133.4 mm (3.0 x 2.87 x 5.25 in.)	112 x 123 x 67 mm (4.41 x 4.84 x 2.64 in.)
Mounting type	-	Metal panel

General Specifications

Enclosure type rating	None (open-style)	Meets IP65/66/67/69K (when marked)
Terminal base screw torque	0.8 Nm (7 lb-in)	0.8 Nm (7 lb-in)
Weight, approx.	0.28 Kg (0.62 lb)	0.33 Kg (0.72 lb)

(1) Use this Conductor Category information for planning conductor routing. Refer to Industrial Automation Wiring and Grounding Guidelines, publication [1770-IN041](#) and to the appropriate System Level Installation Manual.

Power Supply

The 1734-AENTR and 1738-AENTR modules have the following power supply specifications:

Power Supply Specifications

Attributes	1734-AENTR	1738-AENTR
Input voltage rating	24V DC@ 500mA, 12V DC@ 1.0A	24V DC@ 500mA, 12V DC@ 1.0A
Input voltage, range	10...28.8V DC	10...28.8V DC
Field side power, max	24V DC@ 400mA	24V DC@ 400mA
Inrush current, max	6 A for 10 ms	6 A for 10 ms
Input overvoltage protection	Reverse polarity protected	Reverse polarity protected
POINTBus output current, max	5V DC @ 0.8A	5V DC @ 0.8A
Interruption	Output voltage stays within specifications when input drops out for 10 ms @ 10V with max load	
Auxiliary power cable ⁽¹⁾	Standard cordset (single-ended), for example Allen-Bradley part number 889N-F4AFC-6F or 889N-R4AFC-6F. Standard patchcord (double-ended), for example, Allen-Bradley part number 889N-F4AFNU-6F or 889N-F4AFNV-6F.	

(1) Refer to publication [M117-CA001A-EN-P](#) for more information.

EtherNet Communication

The 1734-AENTR and 1738-AENTR adapter modules have the following EtherNet communication specifications.

EtherNet Communication Specifications

Attributes	Description
Ethernet communication rate	10/100 Mbps/s, half or full-duplex
Ethernet ports	2, configured as Embedded Switch
Ethernet network topologies supported	Star, Tree, Daisy-chain/Linear, and Ring

EtherNet Communication Specifications

Attributes	Description
Ethernet connectors	1734-AENTR – RJ-45, Category 5 1738-AENTR – M12
Ethernet cable	Category 5: shielded or unshielded
Ethernet wire connections, max	See Wire Size on page 92

Environmental Specifications

The 1734-AENTR and 1738-AENTR Dual Port EtherNet/IP Adapter modules have the following environmental specifications.

Environmental Specifications

Attributes	1734-AENTR	1738-AENTR
Temperature, operating	IEC 60068-2-1 (Test Ad, Operating Cold), IEC 60068-2-2 (Test Bd, Operating Dry Heat), IEC 60068-2-14 (Test Nb, Operating Thermal Shock): -20...55 °C (-4...131 °F)	IEC 60068-2-1 (Test Ad, Operating Cold), IEC 60068-2-2 (Test Bd, Operating Dry Heat), IEC 60068-2-14 (Test Nb, Operating Thermal Shock): -20...60 °C (-4...140 °F)
Temperature, nonoperating	IEC60068-2-1 (Test Ab, Unpackaged Nonoperating Cold) IEC60068-2-2 (Test Bb, Unpackaged Nonoperating Dry Heat) IEC60068-2-14 (Test Na, Unpackaged Nonoperating Thermal Shock): -40...85 °C (-40...185 °F)	
Temperature, surrounding air, max	55 °C (131 °F)	60 °C (140 °F)
Relative humidity	IEC 60068-2-30 (Test Db, Unpackaged Damp Heat): 5...95% non-condensing	
Vibration	IEC 60068-2-6 (Test Fc, Operating): 5 g @ 10...500 Hz	
Shock, operating	IEC60068-2-27 (Test Ea, Unpackaged Shock): 30 g	
Shock, nonoperating	IEC60068-2-27 (Test Ea, Unpackaged Shock): 50 g	
Emissions	CISPR 11: Group 1, Class A	CISPR 11: Group 1, Class A
ESD immunity	IEC61000-4-2: 6 kV contact discharges 8 kV air discharges	IEC 61000-4-2: 6 kV contact discharges 8 kV air discharges
Radiated RF immunity	IEC 61000-4-3: 10V/m with 1 kHz sine-wave 80% AM from 80...2000 MHz 10V/m with 200 Hz 50% Pulse 100% AM @ 900 MHz 10V/m with 200 Hz 50% Pulse 100% AM @ 1890 MHz 10V/m with 1 kHz sine-wave 80% AM from 2000...2700 MHz	
EFT/B immunity	IEC 61000-4-4: ±4 kV @ 5 kHz on power ports ±3 kV @ 5 kHz on communications ports	IEC 61000-4-4: ±4 kV @ 2.5 kHz on power ports ±3 kV @ 5 kHz on communications ports

Environmental Specifications

Attributes	1734-AENTR	1738-AENTR
Surge transient immunity	IEC 61000-4-5: <ul style="list-style-type: none"> • ± 1 kV line-line (DM) and ± 2 kV line-earth (CM) on power ports • ± 2 kV line-earth (CM) on communications ports 	IEC 61000-4-5: <ul style="list-style-type: none"> • ± 1 kV line-line (DM) and ± 2 kV line-earth (CM) on power ports • ± 2 kV line-earth (CM) on communications ports
Conducted RF immunity	IEC61000-4-6: 10V rms with 1 kHz sine-wave 80% AM from 150 kHz...80 MHz	IEC 61000-4-6: 10V rms with 1 kHz sine-wave 80% AM from 150 kHz...80 MHz
North American temp code	T4	-
IEC Temp Code	T4	-

Notes:

Adapter Web Dialogs

Overview

The Web dialog of the I/O adapter offers extensive internal and network diagnostics. To view the Web dialogs, enter the IP address of the I/O adapters into your browser.

For Information About	Page
Work with the Home Page	97
Work with the Diagnostics Pages	99
Use the Diagnostic Overview Page	100
Use the Network Settings Page	101
Use the Ethernet Statistics Page	102
Use the I/O Connections Page	104
Use the Advanced Diagnostics Page	105
Work with the Configuration Pages	106
Use the Identity Page	108
Use the Network Configuration Page	109
Use the Services Page	110
Work with the Browse Chassis Page	111

Work with the Home Page

Use the adapter diagnostics home page to access other adapter diagnostics web pages and see the following information.

- Host Name
- Module Name
- Module Description
- Module Location
- IP Address
- Ethernet Address (MAC)
- DHCP Enabled
- Status
- Serial Number
- Product Revision
- Firmware Version Date

To display and work with the adapter diagnostics home page, follow these procedures.

IMPORTANT Make sure that your PC Internet LAN setting and your TCP/IP settings are configured to access the subnet on which your adapter communicates.

1. From your web browser, enter the adapter IP address to see the Home page.

Enter the adapter IP address to see the home page.

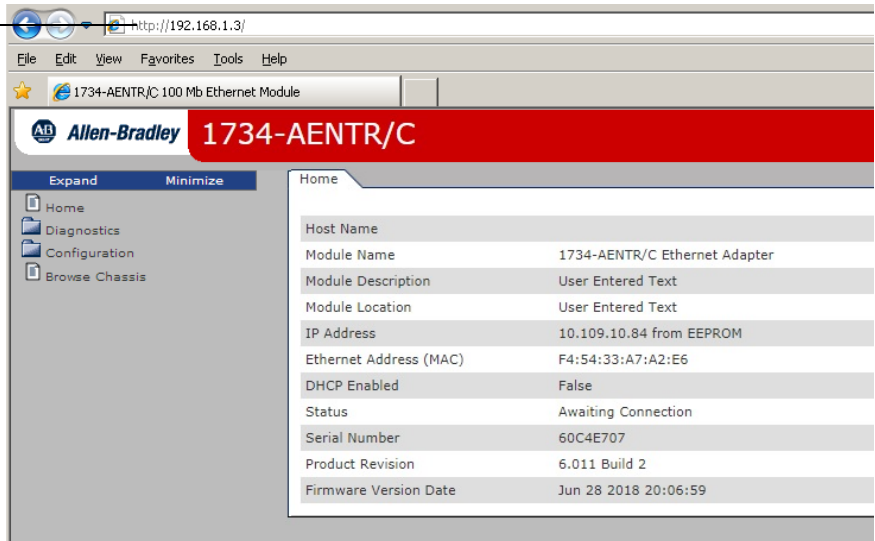

2. From the Home page, click Expand to show options, or minimize to see Diagnostics, Configuration, and Browse Chassis options without the expansion.

Click Expand to show options.

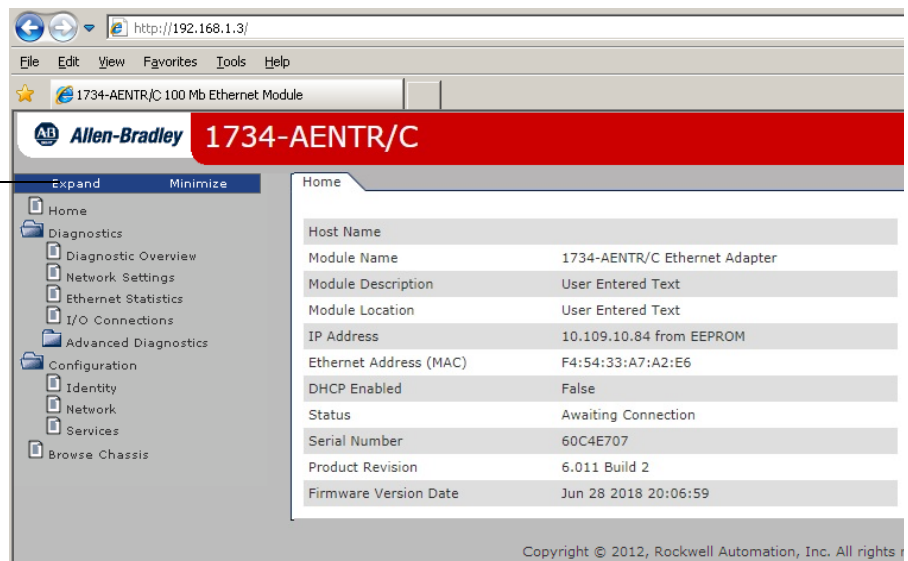

3. From the Home page, complete one of these, as desired.
 - Click one of the following to access www.ab.com.
 - Allen-Bradley logo at the top of the page

- Visit ab.com for additional information statement under Resources
- Click Rockwell Automation at the top right to go to www.rockwellautomation.com.
- Click the following to see additional diagnostics web pages.
 - Diagnostics - Diagnostic overview, Network Settings, Ethernet Statistics, I/O Connections, Advanced Diagnostics
 - Configuration - Identity, Network, Services
 - Browse Chassis

Work with the Diagnostics Pages

To work with the Diagnostics options, follow these procedures.

1. From the Home page, click Diagnostics or Expand to see the following diagnostics options from the panel at the left.
 - Diagnostic Overview
 - Network Settings
 - Ethernet Statistics
 - I/O Connections
 - Advanced Diagnostics
2. In the Refresh Rate field, you can type a refresh rate, noting that the default rate is 15 seconds.
3. From the panel at the left or tabs at the top of the page, click one of the diagnostics options to see the corresponding page.

Click tabs to see the corresponding page.

Click from this panel to see the corresponding page.

Type a refresh rate.

Ring Status		Module Si
Network Topology	Ring	Chassis Si
Network Status	Ring Fault	Switches
Ring Supervisor	00:00:BC:C3:0A:A3 192.168.1.1	

System Resource Utilization	
CPU Utilization	20.6% (20.7%[pk])
Module Uptime	00h:39m:54s

CIP Connection Statistics	
Current CIP Msg Connections	0

Use the Diagnostic Overview Page

To use the Diagnostic Overview page for general diagnostics information, follow this procedure.

1. Click Diagnostic Overview from the tab at the top of the page or panel on the left.
The Diagnostic Overview page opens.

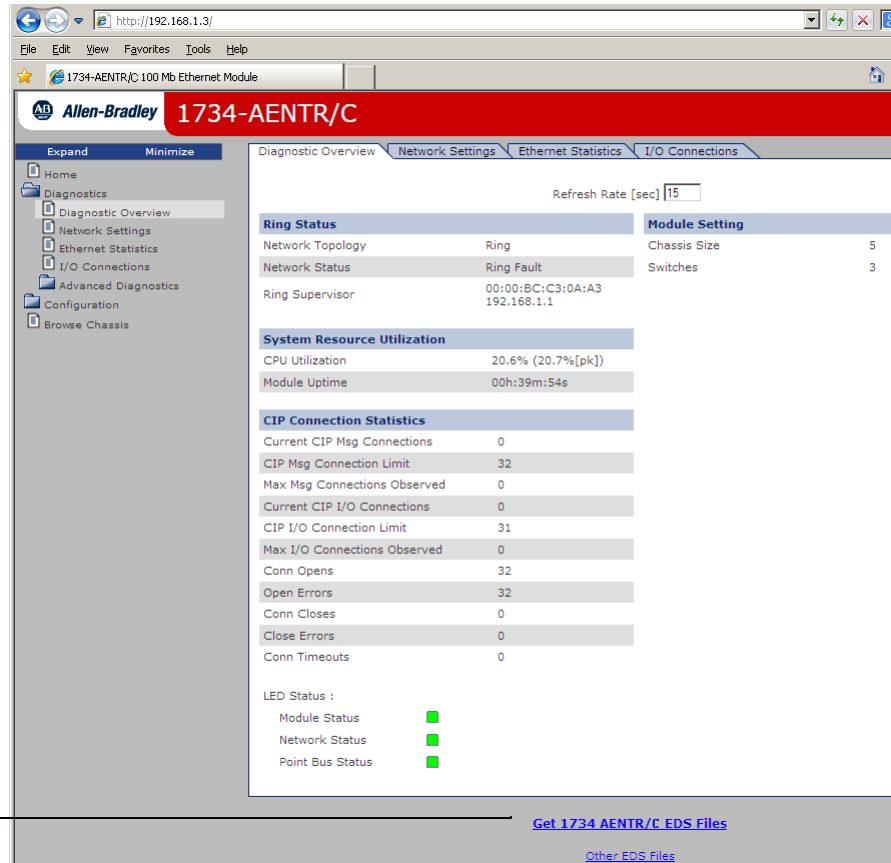

Download EDS files for your adapter

2. From the Diagnostic Overview page, view the following:
 - Ring Status
 - Network Topology
 - Network Status
 - Ring Supervisor
 - System Resource Utilization
 - CPU Utilization
 - Module Uptime
 - CIP Connection Statistics
 - Current CIP MSG Connections
 - CIP MSG Connection Limit
 - Max Msg Connections Observed

- Current CIP I/O Connections
- CIP I/O Connection Limit
- Max I/O Connections Observed
- Conn Opens
- Open Errors
- Conn Closes
- Close Errors
- Conn Timeout
- Status
- Module Settings
 - Chassis Size
 - Switches

Use the Network Settings Page

To use the Network Settings page for network related information, follow this procedure.

1. Click Network Settings from the tab at the top of the page or panel on the left.

This opens the Network Settings page.

The screenshot displays the Network Settings page for the Allen-Bradley 1734-AENTR/C module. The page is divided into several sections:

- Network Interface:**
 - Ethernet Address (MAC): 00:00:BC:CF:6B:CB
 - IP Address: 192.168.1.3
 - Subnet Mask: 255.255.255.0
 - Default Gateway: 192.168.1.1
 - Primary Name Server: 0.0.0.0
 - Secondary Name Server: 0.0.0.0
- Ethernet Interface Configuration:**
 - Obtain Network Configuration: Static
- Ethernet Port 1:**
 - Interface State: Enabled
 - Link Status: Active
 - Media Speed: 100Mbps
 - Duplex: Full Duplex
 - Autonegotiate Status: Autonegotiate completed
- Ethernet Port 2:**
 - Interface State: Unknown
 - Link Status: Inactive
 - Media Speed: Unknown
 - Duplex: Unknown
 - Autonegotiate Status: Unknown

2. From the Network Settings page, view the following:
 - Network Interface
 - Ethernet Address (MAC)
 - IP Address

- Subnet Mask
- Default Gateway
- Primary Name Server
- Secondary Name Server
- Default Domain Name
- Host Name
- Name Resolution
- Ethernet Interface Configuration
 - How the Network Configuration was obtained - Static or Dynamic
- Ethernet Port 1
 - Interface State
 - Link Status
 - Media Speed
 - Duplex
 - Autonegotiate Status
- Ethernet Port 2
 - Interface State
 - Link Status
 - Media Speed
 - Duplex
 - Autonegotiate Status

Use the Ethernet Statistics Page

To use the Ethernet Statistics page for information about the Ethernet link and interface and media counters, use this procedure.

1. Click the Ethernet Statistics tab at the top of the page or on the left panel.

The Ethernet Statistics page opens.

The screenshot displays the Ethernet Statistics page for the 1734-AENTR/C module. The page is organized into a navigation sidebar and a main content area. The main content area features a 'Refresh Rate [sec]' dropdown set to 15. Below this, there are three tables: 'Ethernet Port 1', 'Ethernet Port 2', and 'Interface Counters'. The 'Ethernet Port 1' table shows an active link at 100Mbps in Full Duplex mode. The 'Ethernet Port 2' table shows an inactive link. The 'Interface Counters' table shows 336,676 octets received and 349,215 octets transmitted. Media counters for both ports show zero errors.

Ethernet Port 1		Media Counters Port 1	
Interface State	Enabled	Alignment Errors	0
Link Status	Active	FCS Errors	0
Media Speed	100Mbps	Single Collisions	0
Duplex	Full Duplex	Multiple Collisions	0
Autonegotiate Status	Autonegotiation completed	SQE Test Errors	0
		Deferred Transmissions	0
		Late Collisions	0
		Excessive Collisions	0
		MAC Transmit Errors	0
		Carrier Sense Errors	0
		Frame Too Long	0
		MAC Receive Errors	0

Ethernet Port 2		Media Counters Port 2	
Interface State	Unknown	Alignment Errors	0
Link Status	Inactive	FCS Errors	0
Media Speed	Unknown	Single Collisions	0
Duplex	Unknown	Multiple Collisions	0
Autonegotiate Status	Unknown	SQE Test Errors	0
		Deferred Transmissions	0
		Late Collisions	0
		Excessive Collisions	0
		MAC Transmit Errors	0
		Carrier Sense Errors	0
		Frame Too Long	0
		MAC Receive Errors	0

Interface Counters		Media Counters Port 2	
In Octets	336676	Alignment Errors	0
In Ucast Packets	1152	FCS Errors	0
In NUCast Packets	208	Single Collisions	0
In Discards	0	Multiple Collisions	0
In Errors	0	SQE Test Errors	0
In Unknown Protos	2	Deferred Transmissions	0
Out Octets	349215	Late Collisions	0
Out Ucast Packets	790	Excessive Collisions	0
Out NUCast Packets	40	MAC Transmit Errors	0
Out Discards	0	Carrier Sense Errors	0
Out Errors	0	Frame Too Long	0
		MAC Receive Errors	0

2. From the Ethernet Statistics page, view the following:
 - Ethernet Link
 - Media Speed, Half or Full Duplex, Autonegotiate Status
 - Interface Counters
 - In Octets, In UCast Packets, In NUCast Packets, In Discards, In Errors, In Unknown Protos, Out Octets, Out Ucast Packets, Out NUCast Packets, Out Discards, Out Errors
 - Media Counters
 - Alignment Errors
 - FCS Errors
 - Single Collisions
 - Multiple Collisions
 - SQE Test Errors
 - Deferred Transmissions
 - Late Collisions
 - Excessive Collisions
 - MAC Transmit Errors
 - Carrier Sense Errors
 - Frame Too Long
 - MAC Receive Errors

Use the I/O Connections Page

To use the I/O Connections page for CIP I/O (Class 1) connection information, follow this procedure.

1. Click I/O Connections from the tab at the top of the page or panel on the left.

The I/O Connections page opens.

The top value in this column representing Lost shows the number of packets from the missing source.

The value for Slot shows the slot number of the I/O module this connection is controlling.

Conn #/Uptime	Rcv/Xmt	Conn. ID	Source	Dest	Multicast Addr.	RPI	Lost/Slot
65 00h:01m:07s	Rcv Xmt	0x00031BE0 0x00224215	192.168.1.1 (O) 192.168.1.3 (T)	192.168.1.3 192.168.1.1		250 20	0 1
66 00h:01m:07s	Rcv Xmt	0x00031BE1 0x00224216	192.168.1.1 (O) 192.168.1.3 (T)	192.168.1.3 192.168.1.1		20 20	0 2
67 00h:01m:07s	Rcv Xmt	0x00031BE2 0x00224217	192.168.1.1 (O) 192.168.1.3 (T)	192.168.1.3 192.168.1.1		80 80	0 4
68 00h:01m:07s	Rcv Xmt	0x00031BF5 0x00224218	192.168.1.1 (O) 192.168.1.3 (T)	192.168.1.3 192.168.1.1		500 80	0 3

2. From the I/O Connections page, view the following:
 - Connection Number
 - Uptime
 - Receive and Transmit (Rcv/Xmt)
 - Connection ID
 - Source IP Address with an indication of the following:
 - (O) for originator
 - (T) for target
 - Destination IP Address
 - Multicast Address
 - Requested Packet Interval (RPI)
 - Lost/Slot that shows the number of lost packets and the slot number for the connection, with a slot value of 0 indicating that this is a rack-optimization connection
 - Size of data in bytes

Use the Advanced Diagnostics Page

To use the Advanced Diagnostics page to review message services, use this procedure.

1. Click Advanced Diagnostics from the tab at the top of the page or panel on the left. The Advanced Diagnostics page opens.
2. From the Advanced Diagnostics page, select Backplane Statistics to see values similar to that shown.

The screenshot shows a web browser window at http://192.168.1.3/ displaying the Allen-Bradley 1734-AENTR/C interface. The left sidebar shows a navigation tree with 'Advanced Diagnostics' expanded and 'Backplane Statistics' selected. The main content area is divided into two tabs: 'Backplane Statistics' (active) and 'Module Statistics'. A 'Refresh Rate [sec]' input field is set to 15. The 'Backplane Statistics' section contains two tables: 'BP Bus Load Counters' and 'BP Counters'. The 'Module Timeout Counters' section contains a table with 21 rows and 6 columns.

BP Bus Load Counters	
BP Bus Load	0.0%
BP Bus Peak Load	4.52%
BP Packet Rate [pkt/s]	0

BP Counters	
Receive Interrupt	318
Receive Message Counter	318
Receive IO Message	0
Receive EM Message	318
Receive Queue Full Discard	0
Transmit Interrupt	826
Transmit Message	826
Transmit Length Error	0
Transmit Queue Full Discard	0
BP Interrupt Errors	4
BP Overrun Error	0
BP Driver Interrupt	1146
BP Signal Interrupt	1146
BP Driver Reset	0
BP Driver ISR Discard	0
BP Rx Bytes	3557
BP Tx Bytes	8480
BP Transmit Not Ready	1

Module Timeout Counters					
Slot No	Timeout Counters	Slot No	Timeout Counters	Slot No	Timeout Counters
1	0	22	0	43	0
2	0	23	0	44	0
3	0	24	0	45	0
4	0	25	0	46	0
5	0	26	0	47	0
6	0	27	0	48	0
7	0	28	0	49	0
8	0	29	0	50	0
9	0	30	0	51	0
10	0	31	0	52	0
11	0	32	0	53	0
12	0	33	0	54	0
13	0	34	0	55	0
14	0	35	0	56	0
15	0	36	0	57	0
16	0	37	0	58	0
17	0	38	0	59	0
18	0	39	0	60	0
19	0	40	0	61	0
20	0	41	0	62	0
21	0	42	0	63	0

- From the Advanced Diagnostics page, select Module Statistics to see values similar to that shown.

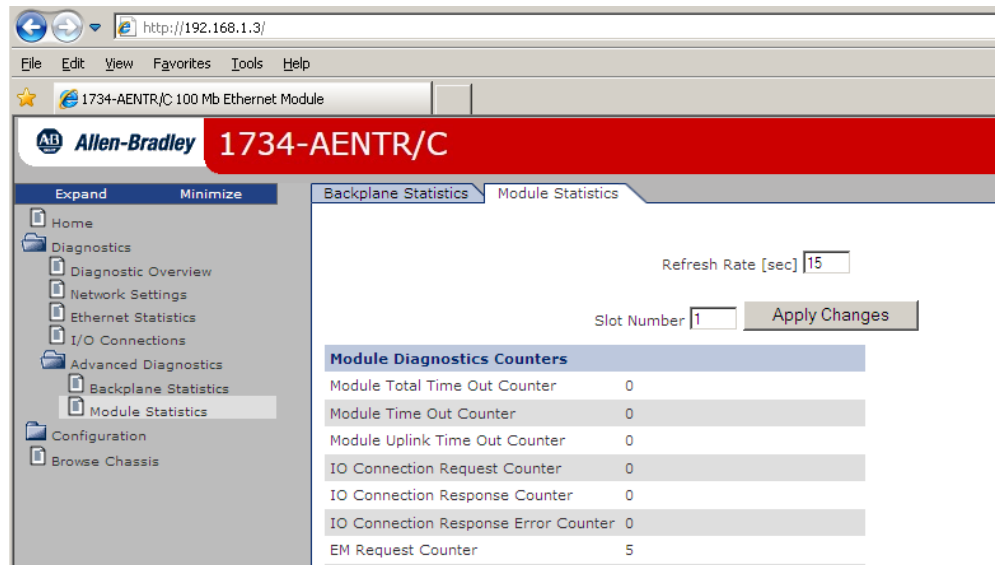

Work with the Configuration Pages

To work with the Configuration pages, follow these procedures.

IMPORTANT

The values on these pages are in non-volatile memory. Changes to these parameters do not take effect until you reset or cycle power through the I/O adapters.

IMPORTANT

If you set the value of the I/O adapters switch to 888 and then power cycle the module, the following occurs:

- The DHCP Enabled function is enabled (set to True).
- The Ethernet link is negotiated automatically. The Auto Negotiate function is set to True.
- The web server is enabled. The Disabled Web Server function is disabled.
- The Ethernet port are disabled. Both ports are re-enabled once the switches are returned to their previous value and power is cycled.
- The password for this page resets to the factory default which is "password".

Note the value of the switches before you enter the 888 value because you must return the adapter to those values once this process is complete.

1. From the Home page, click Configuration or Expand to see the Configuration options, if needed.
2. From the Configuration page, click one of the following:
 - Identity
 - Network
 - Services

A login dialog opens as shown. The dialog may vary in appearance depending on your operating system and browser.



3. From the user name and password dialog, enter values, noting the following:
 - The values for user name and password are case sensitive.
 - The default user name is admin.
 - The default password is “password”.
4. Click OK to log in. After you log in, you can go to any of the Configuration pages without having to log in again.
5. Refer to the section of this manual that corresponds to the section you clicked:
 - Identity
 - Network Configuration
 - Services

Use the Identity Page

To use the Identity page to make entries for the host name, module description, module location, and chassis size, use this procedure.

1. Click Identity from the tab at the top of the page or panel on the left.

The Identity page opens

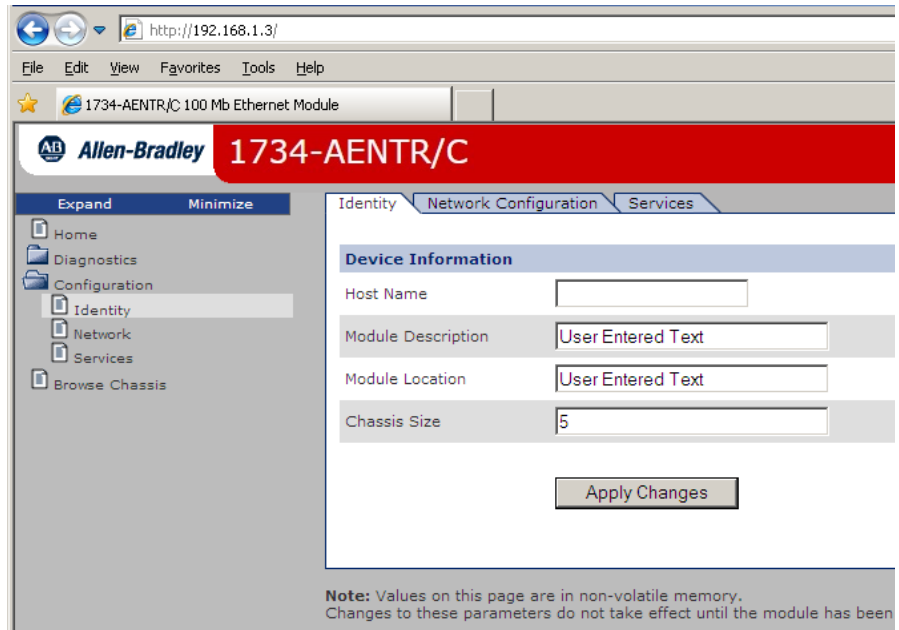

2. From the Identity page, complete entries for the following, noting that the description and location help you identify where modules are in the facility:
 - Host Name – the name a Domain Name Server uses to resolve this adapter's IP address
 - Module Description
 - Module Location
 - Chassis Size - the value that shows the number of I/O modules plus the adapter. This value must match the number of I/O modules plus 1 for the adapter before any I/O connections are allowed.
3. Click Apply Changes to save the modified values.

Use the Network Configuration Page

To use the Network Configuration page to make entries for enabling or disabling DHCP and setting TCP/IP parameters and Ethernet link operation, follow this procedure.

1. Click Network from the tab at the top of the page or panel on the left. The Network Configuration page opens.

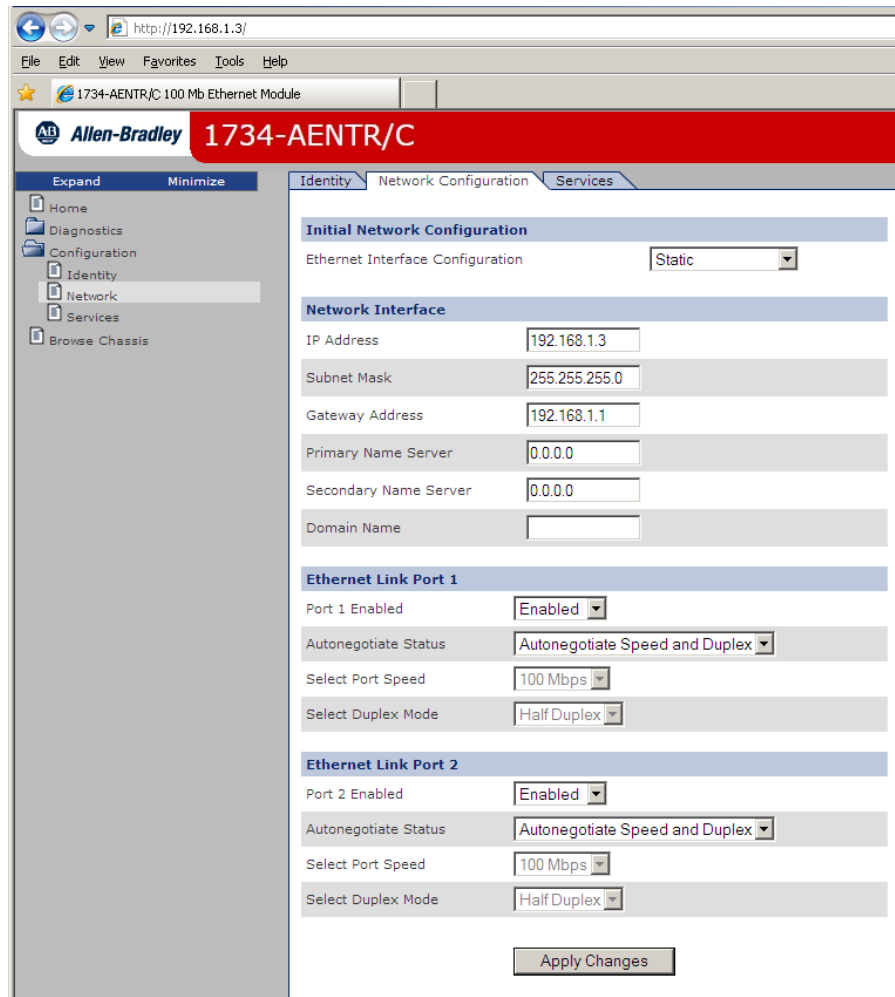

2. From the Network Configuration page, complete these entries, noting that values for Network Interface are disabled when DHCP is Dynamic DHCP and port speed and duplex mode are disabled when Autonegotiate Speed and Duplex is selected.
 - For Initial Network Configuration:
 - Ethernet Interface Configuration
 - Static
 - Dynamic DHCP
 - For Network Interface, select from these choices:
 - IP Address

- Subnet Mask
 - Gateway Address
 - Primary Name Server
 - Secondary Name Server
 - Domain Name
 - For Ethernet Link, select from these choices:
 - Autonegotiate Status
 - Autonegotiate Speed and Duplex
 - Force Speed and Duplex
 - Select Port Speed - 10 megabits, 100 megabits
 - Select Duplex Mode - Half Duplex, Full Duplex
3. From the Network Configuration page, click Apply Changes to save the modified values.

IMPORTANT If there is a mismatch in duplex between the adapter and the connected equipment you may experience 'intermittent connectivity.' For complete details and information on how to resolve this, refer to publication [ENET-A003](#).

Use the Services Page

To use the Services page to change the password for the Configuration web page or disable the web server, complete these procedures.

1. Click Services from the tab at the top of the page or panel on the left. The Services page opens.

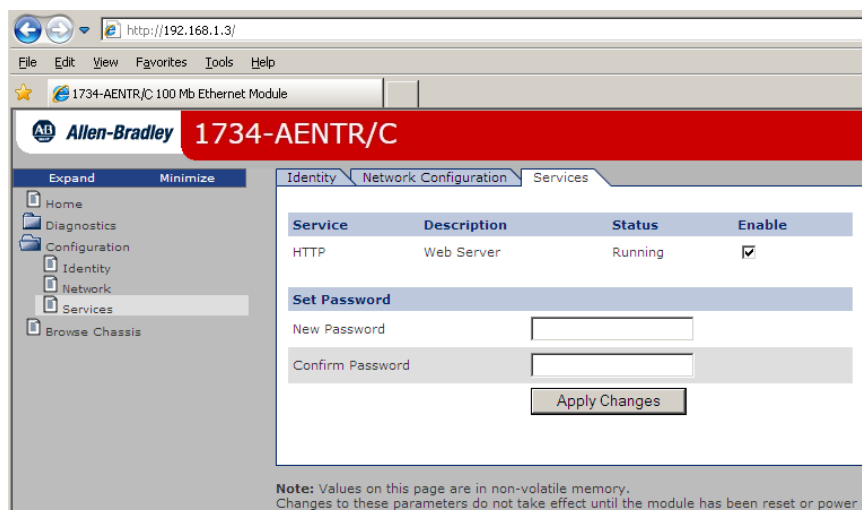

2. From the Services page, make these entries.
 - Click in the Enable box to change whether the web server runs after the module is reset.

- Change the password by typing the new value for New Password and Confirm Password, noting the following:
 - The entry is case sensitive.
 - The default value is the word password.
3. Click Apply Changes.

Work with the Browse Chassis Page

Use the Browse Chassis page for the following:

- See what modules are present on the system.
- Run a query from slot 1 to slot 63.
- Display the modules found based on the query.
- Provide an easy way to see which modules the adapter recognizes on your system.

To work with the Browse Chassis page, follow these procedures.

1. From the Home page, click Browse Chassis.
The following page displays.

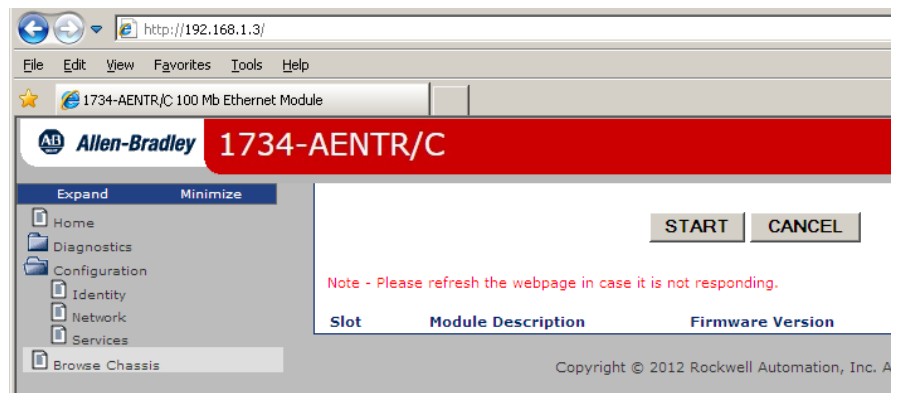

2. Click START to run a query. A Browser Chassis page opens.
Note that module hyperlinks are inactive before the query completes or is cancelled.

After completing a query, here is how a typical Browse Chassis page looks.

If there is no response to the query, the Module not found message appears.

Slot	Module Description	Firmware Version
1	1734-IB8 8 PT 24VDC SINK IN	3.022
2	1734-OB8E 8 PT 24VDC SOURCE OUT	3.022
3	1734-IE2V 2 PT VOLTAGE INPUT	3.004
4	1734-OE2V 2 PT VOLTAGE OUTPUT	3.005
5	Module Not Found	0.000
6	Module Not Found	0.000
7	Module Not Found	0.000
8	Module Not Found	0.000

- To view information about a particular module, click the corresponding Module Description hyperlink. In the following example, the first Module has been selected:

Module Information	Slot 1
Product Name	1734-IB8 8 PT 24VDC SINK IN
Vendor	1
Product Type	7
Product Code	216
Module Revision	3.022
Serial Number	405fa5ce
Device Status	5
Input0	<input type="checkbox"/>
Input1	<input type="checkbox"/>
Input2	<input type="checkbox"/>
Input3	<input type="checkbox"/>
Input4	<input type="checkbox"/>
Input5	<input type="checkbox"/>
Input6	<input type="checkbox"/>
Input7	<input type="checkbox"/>

The 1734 Module Information page opens showing this information about the module:

- Product Name
- Vendor
- Product Type
- Product Code
- Module Revision
- Serial Number
- Status

Configure the RSLinx Ethernet Communication Driver

Overview

To communicate with your adapter over your network, you must configure the RSLinx Ethernet Communication Driver (AB_ETH) or the EtherNet/IP driver (AB-ETHIP). You can configure the AB_ETH driver with the IP addresses of all the Ethernet devices on your system. You need one of these drivers to download the example application programs in this manual.

See the table for a list of the contents of this appendix.

For Information About	Page
Install the RSLinx Software	113
Configure the AB_ETH Driver	114
Configure the AB_ETHIP Driver	116

Install the RSLinx Software

Use this procedure to install the RSLinx software on your computer.

1. Insert the CD in the CD-ROM drive.

Note that the CD-ROM supports Windows Autorun. Once inserted into the CD-ROM drive, if you have Autorun configured, the installation automatically starts at the first setup screen.

If Autorun is not configured for your CD-ROM drive, go to step 2.

2. From the Start menu, choose Run. The Run dialog opens.
3. Type D:/setup (if it doesn't appear automatically), where D: is your CD-ROM drive letter.
4. Click OK.
The progress bar, followed by the welcome screen opens.

Configure the AB_ETH Driver

To configure the AB-ETH Ethernet communication driver perform the following steps:

1. Start the RSLinx software.
2. From the Communications menu, select Configure Drivers.

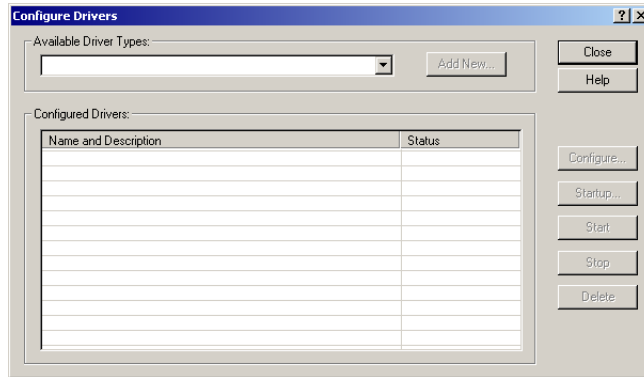

3. Select Ethernet Devices from the list and click Add/New...

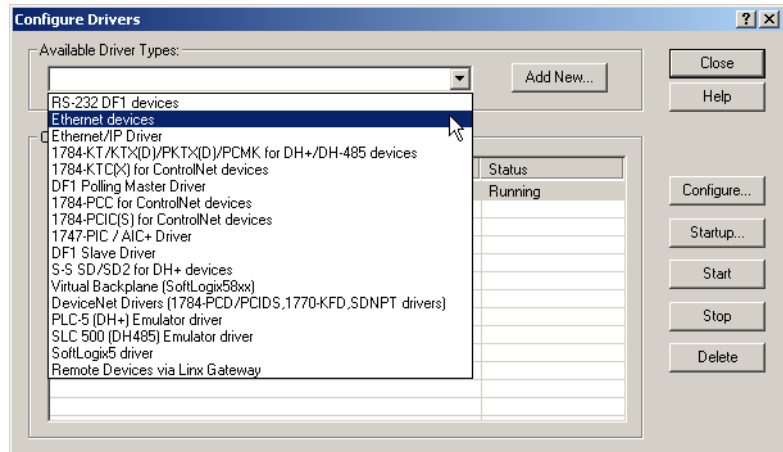

4. Select the default driver name (for example, AB_ETH-1) or type in a name and click OK.

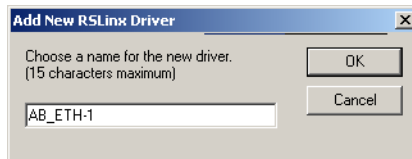

The Configure driver dialog opens.

- Click Add New and enter the IP address or Host Name of your Ethernet device (for example, 10.88.70.4, Pump1).

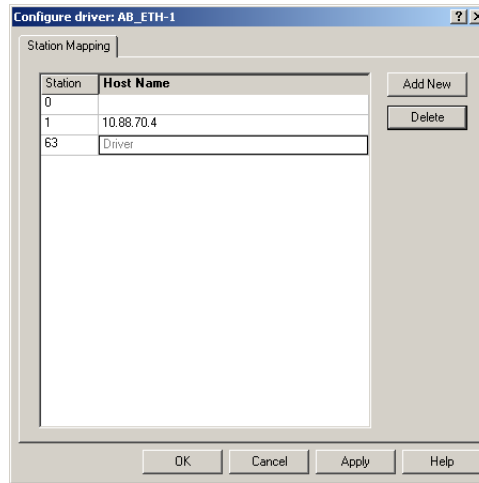

- Repeat step 6 for each additional Ethernet device you need to access.
- After entering the IP addresses, click Apply.
- Click OK to close the Configure driver dialog.

The new driver appears in the list of configured drivers. Your list displays the drivers you configured on your workstation.

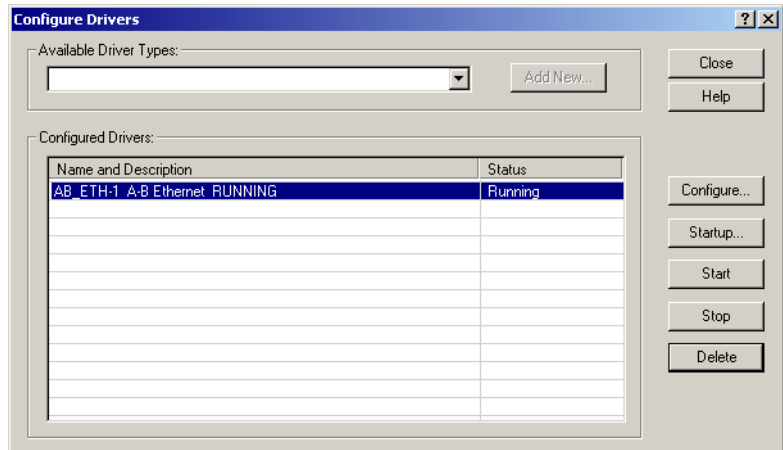

- Close the RSLinx software.

Configure the AB_ETHIP Driver

To configure the AB-ETHIP Ethernet communication driver, perform the following steps.

1. Start the RSLinx software.
2. From the Communications menu, select Configure Drivers.

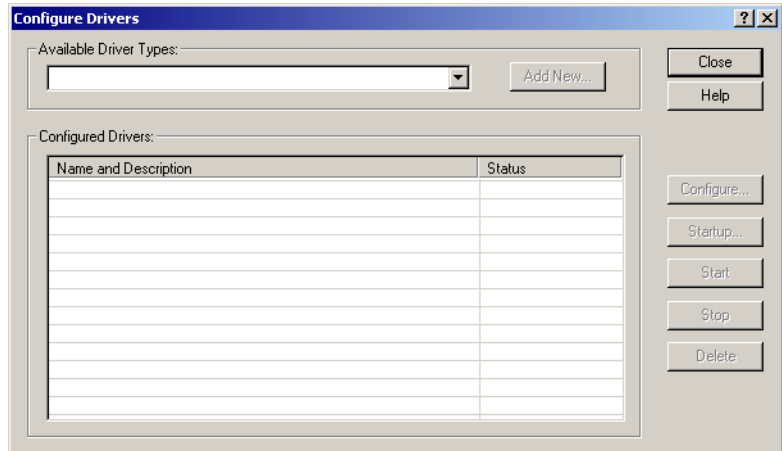

3. Select EtherNet/IP Devices from the list and click Add/New...

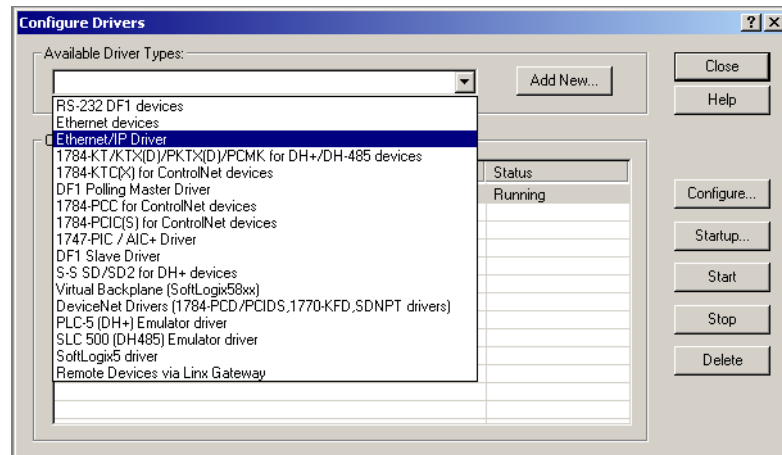

The Configure Driver dialog box opens.

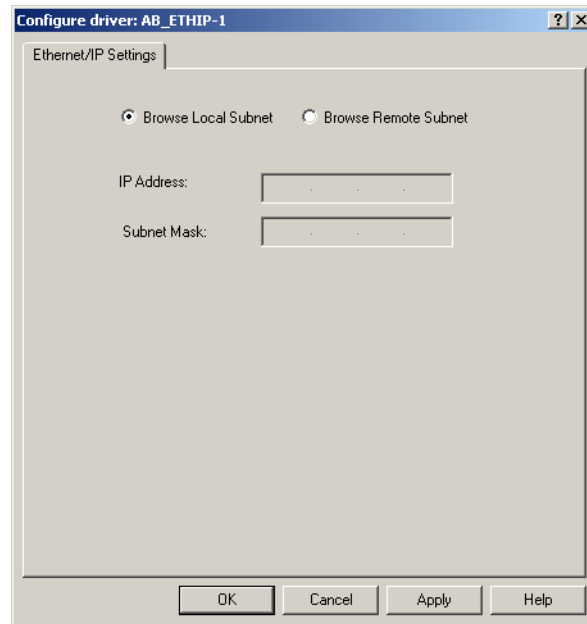

Make sure the Browse Local Subnet button is selected.

The RSLinx software browses your local subnet and automatically reads the IP address.

4. Click OK.

The AB-ETHIP driver is now configured and appears in the configured drivers window.

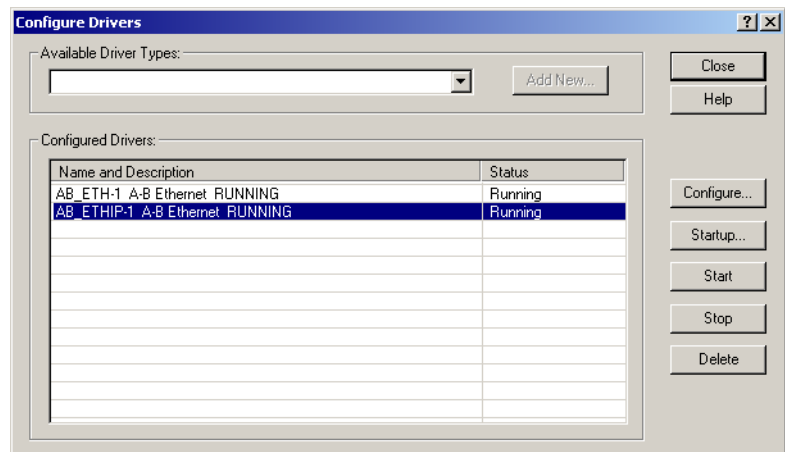

5. Close the RSLinx software.

Notes:

Numerics

1734-AENTR 4

specifications 91, 93

1738-AENTR 4

specifications 91, 93

A

adapter

AENTR 57, 59
diagnostics 97
I/O 2
mounted 36

address

fixed IP 56
Gateway 23, 25
IP 23, 33, 97, 98, 115
network 27
switches 24

Autonegotiate Status 102

B

bandwidth

insufficient 57
limit 57
used 57

BootP/DHCP Server

tool 23, 24, 27, 28, 29

C

chassis

ControlLogix 36
size 5, 108

chassis size

set 5

CIP 9

Common Industrial Protocol 9

common techniques used in this manual x

conducted RF immunity 95

configuration 24, 98, 99

network 107
option 107
page 106, 110

configure

adapter 35
driver dialog 115
for direct connection 35

connection

direct 35

connectors

D-code M12 4

controller

ControlLogix 35
L63 36
tags 83

conventions x

D

daisy chain 1

data

messaging 2

Default Gateway 102

device

consuming 9
producing 9

DHCP

(Dynamic Host Configuration Protocol) 33
server 23, 24
software 33

Diagnostic

messaging 99

diagnostic

general information 100
messaging 99
overview 99

diagnostics 98, 99

additional 99
page 99
web page 97
web pages 99

Dimensions 92

DIN rail 36

direct connection 10, 11, 44, 47, 49, 67, 78, 83

download

program 52

driver

AB_ETH 113
AB-ETHIP 113, 116
configured 115
EtherNet/IP 113
RSLinx Ethernet communication 113

Duplex 102

E

EFT/B immunity 94

empty terminal bases 8

Enclosure type rating 93

enhanced rack-optimization 11

enhanced rack-optimization connection 10

ESD immunity 94

EtherNet

adapter 83

Ethernet 20

device 115
link 109
statistics 99

Ethernet cable 94
Ethernet communication rate 93
Ethernet connectors 94
Ethernet Interface Configuration 102
Ethernet network topologies supported 93
Ethernet ports 93
Ethernet wire connections 94
EtherNet/IP
 bridge 62
 driver 113
 Ethernet Industrial Protocol 9

F

Field power output 92
Field power supply 92
Field side power 93
firmware
 revisions 4

G

Gateway
 default 102
Gateway address 23, 25

H

Home page 97, 99, 111
Host ID 26
Host Name 102, 115
host name 108

I

I/O
 adapter 2, 57, 83
 connection 57
 connection format 59
 direct connection
 rack-optimization connection 59
 module 2
 modules 35, 59
I/O adapter 2
 primary tasks 2
I/O configuration
 folder 62
I/O Connection 104
I/O connection
 direct 59
 enhanced rack-optimization 59
 rack-optimization 59
I/O Connections 104
I/O connections 99, 108
I/O data
 real-time 2

I/O direct connection

enhanced rack-optimization connection 59

I/O Hardware

set up 36, 60

I/O module

bridge 2

Identify

page 108

Identity

page 108

information

configuration 2

programming 2

Input overvoltage protection

92, 93

Input voltage rating

93

Input voltage, range

93

Inrush current

93

Install the ArmorPOINT I/O Module

17

Install the POINT I/O Modules

15

Interface State

102

Interruption

93

IP

address 24

fixed address 56

network 24

IP Address

101

IP address

23, 24, 33, 97, 98, 115

fixed 56

IP network

splitting 26

subgroup 26

subnet 26

Isolation voltage

92

L

ladder logic

program 83

ladder program

example 52

Link Status

102

M

manuals

related ix

Media Counters

103

Media Speed

102

messaging

explicit 2

implicit 2

mix

enhanced rack-optimization 11

model

master/slave 9

producer

consumer 9

producer/consumer 9

Module 3
module 3
 location
 description 108
Module Description 112
Module input 92
modules
 overview 13
Mounting type 92

N

Network
 settings 99
network
 configuration 107
Network Address 23
 thumbwheel 23
network address 27
network address switches 24
Network Configuration 107
Network Settings 101

O

Overview
 1734 POINT I/O and ArmorPOINT I/O Installation 13

P

pen-push
 thumbwheel 27
POINTBus output current 93
power consumption 92
Power dissipation 92
power up system for the first time 9
primary tasks 2
protocol
 message-based 9
publications
 related ix
purpose of this manual ix

R

rack-optimization 11
rack-optimization connection 10
radiated RF immunity 94
rate of change 57
recover from an overloaded adapter 57
Refresh Rate 99
reinsertion of modules 8
Related Documentation ix
related publications ix
Relation List 32
relative humidity 94
relative path 9
removal of modules 8
Remove the POINT I/O Modules 15
replacement of adapter 7
requested packet interval (RPI) 10
revisions
 firmware 4
ring 1
RJ-45 connectors 1
Rockwell
 BootP/DHCP Server tool 24
RPI 57
RPI requested packet interval 10
RSLinx
 Ethernet communication driver 113
RSLinx software 115
 install 113

S

select
 Ethernet Devices 114
Services 107
 page 110
shock
 nonoperating 94
 operating 94
software releases 4
specification
 emissions 94
 ESD immunity 94
specifications
 general 91
statistics
 Ethernet 99
status indicators 85, 92
subgroup 26
subnet 26
Subnet Mask 102
subnet mask 23, 26
surge transient immunity 95

T

TCP/IP network 33

temperature

- ambient 94
- nonoperating 94
- operating 94

Terminal base screw torque 93

Thermal dissipation 92

thumbwheel

- chassis size 6
- network address 27
- settings 5

U

upgrades

- firmware 4
- software 4

Uptime 104

V

vibration 94

W

web

- dialogs 97
- server 110

web dialogs 97

- Advanced Diagnostics 105, 106
- Browse Chassis 98, 99, 111
- Diagnostic Overview 100
- Ethernet Address 101
- Ethernet Link 103
- Ethernet Statistics 99, 102, 103

web page

- diagnostics 99

web server

- disable 110

Weight, approx. 93

wiring 20

Rockwell Automation Support

Rockwell Automation provides technical information on the Web to assist you in using its products.

At <http://www.rockwellautomation.com/support/>, you can find technical manuals, a knowledge base of FAQs, technical and application notes, sample code and links to software service packs, and a MySupport feature that you can customize to make the best use of these tools.

For an additional level of technical phone support for installation, configuration, and troubleshooting, we offer TechConnect support programs. For more information, contact your local distributor or Rockwell Automation representative, or visit <http://www.rockwellautomation.com/support/>.

Installation Assistance

If you experience a problem within the first 24 hours of installation, review the information that is contained in this manual. You can contact Customer Support for initial help in getting your product up and running.

United States or Canada	1.440.646.3434
Outside United States or Canada	Use the Worldwide Locator at http://www.rockwellautomation.com/support/americas/phone_en.html , or contact your local Rockwell Automation representative.

New Product Satisfaction Return

Rockwell Automation tests all of its products to ensure that they are fully operational when shipped from the manufacturing facility. However, if your product is not functioning and needs to be returned, follow these procedures.

United States	Contact your distributor. You must provide a Customer Support case number (call the phone number above to obtain one) to your distributor to complete the return process.
Outside United States	Please contact your local Rockwell Automation representative for the return procedure.

Documentation Feedback

Your comments will help us serve your documentation needs better. If you have any suggestions on how to improve this document, complete this form, publication [RA-DU002](#), available at <http://www.rockwellautomation.com/literature/>.

Rockwell Automation maintains current product environmental information on its website at <http://www.rockwellautomation.com/rockwellautomation/about-us/sustainability-ethics/product-environmental-compliance.page>.

Rockwell Otomasyon Ticaret A.Ş., Kar Plaza İş Merkezi E Blok Kat:6 34752 İçerenköy, İstanbul, Tel: +90 (216) 5698400

www.rockwellautomation.com

Power, Control and Information Solutions Headquarters

Americas: Rockwell Automation, 1201 South Second Street, Milwaukee, WI 53204-2496 USA, Tel: (1) 414.382.2000, Fax: (1) 414.382.4444

Europe/Middle East/Africa: Rockwell Automation NV, Pegasus Park, De Kleetlaan 12a, 1831 Diegem, Belgium, Tel: (32) 2 663 0600, Fax: (32) 2 663 0640

Asia Pacific: Rockwell Automation, Level 14, Core F, Cyberport 3, 100 Cyberport Road, Hong Kong, Tel: (852) 2887 4788, Fax: (852) 2508 1846

Rockwell Automation Publication 1734-UM017E-EN-E - May 2019

Supersedes publication 1734-UM017D-EN-E - September 2017

Copyright © 2019 Rockwell Automation, Inc. All rights reserved.